

# RAIDER®



2020-2021



Евромастер Импорт-Експорт ООД е основана през 1992 г. и днес заема водещо място на пазара на професионалните и хоби инструменти в България, постигайки устойчив растеж през годините. Нашата мисия, вече 28 години, е да задоволяваме потребителското търсене, спазвайки европейските стандарти за качество, като произвеждаме, доставяме, развиваме и разширяваме асортимента ни от висококачествени продукти.

Най-важните предпоставки за успех на компанията са: Опитът, натрупан от изучаване на световните тенденции в търговията с електро и механични инструменти; Куражът, да се следва по-трудния, но в перспектива по-успешен път на създаване, развиване и налагане на собствени марки; Доверието към всеки служител на фирмата и всеки бизнес партньор.

„Ние знаем в какво сме най-добри и сме насочили цялата си енергия към затвърждаването на позициите ни като лидер на българския пазар. Фокусирани сме върху това да вършим прекрасно работата си, да създаваме инструменти и машини, които да направят живота Ви по-лек и по-добър. Стремим се да бъдем блестящи във всеки детайл, давайки изключителна стойност на нашите продукти.

Така постигаме своите успехи.“

---

Euromaster Import - Export Ltd. was founded in 1992 and today occupies a leading position in the market of professional and hobby tools in Bulgaria, achieving a sustainable level of growth over the years. Our mission for 28 years now, has been to meet the consumer demand, complying with European quality standards by manufacturing, supplying, developing and expanding our range of high quality products.

The most important prerequisites for the company's success are:

Experience gained from the study of global trends in the trade of power and hand tools;

Courage to follow the more difficult, but in perspective the more successful way of creating,

Development and enforcement of own brands; Trust in each company employee and business partner.

“We know what we are good at and direct all our energy to strengthen our position as a leader on the Bulgarian market. We are focused on doing our job perfectly, to create hand and power tools and to make your life easier and better. We strive to be brilliant in every detail, providing exceptional value to our products.

That is how we achieve our successes.”



# RAIDER®

## Pro

**R20** System

**20**  
YEARS  
ANNIVERSARY



# ONE BATTERY FITS ALL



## CORDLESS DRILL RDP-SCD20

[BG] Акумулаторна бормашина • [RO] Masina de gaurit si insurubat • [SR] Bušilica • [MK] Батериска бормашина • [RU] Аккумуляторная дрель  
 • [SL] Akumulatorski vrtnik vijasnik • [EL] Δραπανοκατσαβίδα • [HR] Akumulatorska bušilica • [FR] Perceuse sans fil • [IT] Trapano senza cordone  
 • [ES] Taladro inalámbrico sin batería y cargador • [PT] Aparafusadora

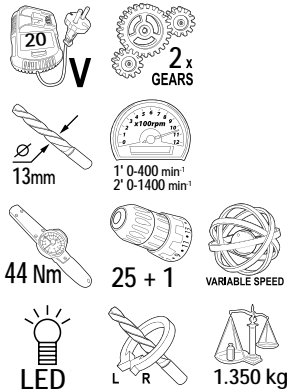

TWO GEARS



CHARGING TIME  
1 HOUR



ERGONOMIC  
SOFT HANDLE

### RDP-SCD20 SOLO

Art.No	gross weight	in cartoon	barcode
030130	1.500 kg	10 pcs	3800123168185

### RDP-SCD20 WITH BATTERY 1.5Ah SET

Art.No	gross weight	in cartoon	barcode
030211	2.320 kg	10 pcs	3800972005372

## CORDLESS DRILL RDP-SCD20S

[BG] Акумулаторна бормашина • [RO] Masina de gaurit si insurubat • [SR] Bušilica • [MK] Батериска бормашина • [RU] Аккумуляторная дрель  
 • [SL] Akumulatorski vrtnik vijasnik • [EL] Δραπανοκατσαβίδα • [HR] Akumulatorska bušilica • [FR] Perceuse sans fil • [IT] Trapano senza cordone  
 • [ES] Taladro inalámbrico sin batería y cargador • [PT] Aparafusadora

**NEW  
PRODUCT**

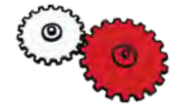
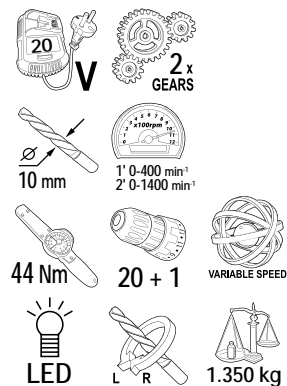

TWO GEARS



CHARGING TIME  
1 HOUR



ERGONOMIC  
SOFT HANDLE

### RDP-SCD20S SOLO

Art.No	in cartoon	barcode
030220	10	3800972017191

### RDP-SCD20S WITH 1 BATTERY 2Ah SET IN CASE

Art.No	barcode
030219	3800972017184

### RDP-SCD20S WITH 2 BATTERIES 2Ah SET IN CASE

Art.No	barcode
030218	3800972017177

## CORDLESS HAMMER DRILL - DRIVER RDP-SCDI20

[BG] Бормашина ударна акумулаторна • [RO] Masina de gaurit si insurubat cu percutie • [SR] Bušilica • [MK] Батериска бормашина • [RU] Аккумуляторная дрель • [SL] Akumulatorski vrtnik vijasnik • [EL] Δραπανοκατσαβίδα • [HR] Akumulatorska bušilica • [FR] Perceuse sans • [IT] Trapano senza cordone • [ES] Taladro inalámbrico • [PT] Aparafusadora de percussão

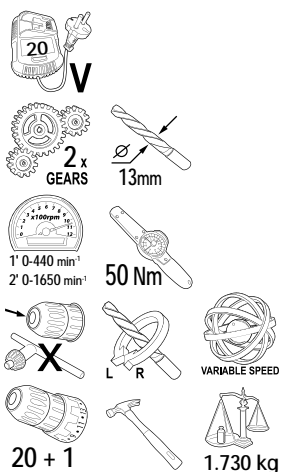

IMPACT FUNCTION

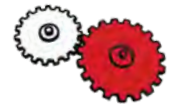

TWO GEARS



CHARGING TIME  
1 HOUR



ERGONOMIC  
SOFT HANDLE

### RDP-SCDI20 SOLO

Art.No	gross weight	in cartoon	barcode
030131	1.920kg	5 pcs	3800123168277

### RDP-SCDI20 WITH 2 BATTERIES 2Ah SET IN CASE

Art.No	gross weight	in cartoon	barcode
030208	4.250 kg	4 pcs	3800972005341



**CORDLESS HAMMER DRILL RDP-SCDI20S**

[BG] Бормашина ударна акумулаторна • [RO] Masina de gaurit si insurubat cu percutie • [SR] Bušilica • [MK] Батериска бормашина  
 • [RU] Акумуляторная дрель • [SL] Akumulatorski vrtnik vijacnik • [EL] Δραπανοκατασβίδο • [HR] Akumulatorska bušilica • [FR] Perceuse sans  
 • [IT] Trapano senza cordone • [ES] Taladro inalámbrico • [PT] Aparafusadora de percussão

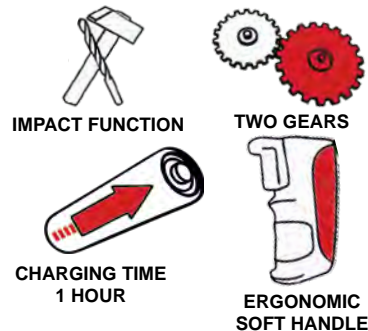
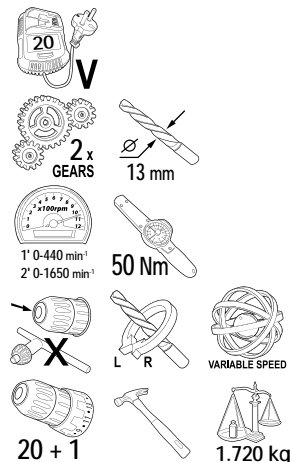

**RDP-SCDI20S SOLO**

Art.No	gross weight	barcode
030217	1.920 kg	3800972017160

**RDP-SCDI20S WITH 2 BATTERIES 2Ah SET IN CASE**

Art.No	gross weight	barcode
030216	4.250 kg	3800972017153

**AUTO TOUCH CORDLESS DRILL WITHOUT BATTERY AND CHARGER SOLO RDP-SCDA20**

[BG] Бормашина акумулаторна без батерия и зарядно • [RO] Masina si insurubat cu percutie fără baterie și încărcător • [SR] Bušilica bez baterija i punjač • [MK] Батериска бормашина без батерија и полнач  
 • [RU] Акумуляторная дрель без аккумулятора и зарядного устройства • [SL] Akumulatorski vrtnik vijacnik brez baterije in polnilnika • [EL] Δραπανοκατασβίδο χωρίς μπαταρία και φορτιστή  
 • [HR] Akumulatorska bušilica bez baterije i punjača • [FR] Perceuse sans fil sans batterie et chargeur • [IT] Trapano senza cordone senza batteria e caricabatterie • [ES] Taladro inalámbrico sin batería y cargador  
 • [PT] Aparafusadora de percussão sem bateria e carregador

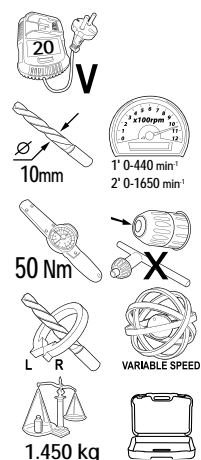

AUTO TOUCH

**RDP-SCDA20 SOLO**

Art.No	barcode
030222	3800972017214

**BRUSHLESS CORDLESS DRILL WITH BATTERY AND CHARGER RDP-SBCD20 SET**

• [BG] Акумуляторна бормашина безчеткова с батерия и зарядно • [RO] Masina de gaurit si insurubat cu baterie și încărcător • [SR] Bušilica sa akumulatorom s baterija i punjač • [MK] Батериска бормашина со батерија и полнач  
 • [RU] Акумуляторная дрель с аккумулятором и зарядным устройством • [SL] Akumulatorski vrtnik vijacnik z baterijo in polnilnikom • [EL] Δραπανοκατασβίδο με μπαταρία και φορτιστή  
 • [HR] Akumulatorska bušilica s baterijom i punjačem • [FR] Perceuse sans fil avec batterie et chargeur • [IT] Trapano senza cordone con batteria e caricabatterie • [ES] Taladro inalámbrico con batería y cargador  
 • [PT] Aparafusadora com bateria e carregador

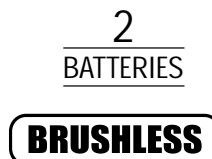
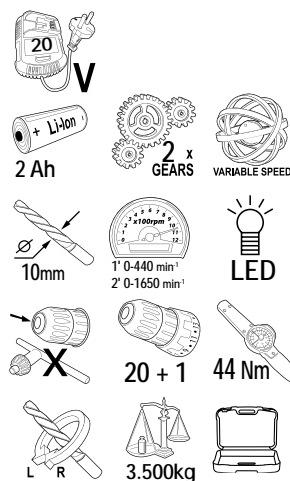

TWO GEARS



CHARGING TIME 1 HOUR



ERGONOMIC SOFT HANDLE

**RDP-SBCD20 SET**

Art.No	barcode
030215	3800972017146

## BRUSHLESS CORDLESS DRYWALL SCREWDRIVER SOLO RDP-SBES20

[BG] Акумулаторен безщетков винтоверт за гипсокартон без батерия и зарядно • [RO] Surubelnita cu impact fara baterie si incarcator • [SR] Odvijač • [MK] Батериска штрафилица • [RU] Аккумуляторная отвёртка • [SL] Akumulatorski izvijač zavijake zagrips plošče • [EL] Κατσαβίδι για γυψοσανίδες • [HR] Akumulatorski odvijač • [FR] Tournevis à cloisons sèches • [IT] Cacciavite per cartongesso • [ES] Desegnilo drywall • [PT] Aparafusadora p/ gesso cartonado

**NEW  
PRODUCT**

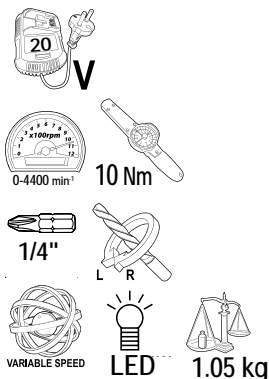

**BRUSHLESS**

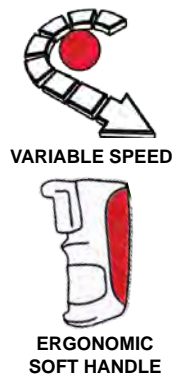

### RDP-SBES20 SOLO

Art.No	gross weight	in cartoon	barcode
030159	1.170 kg	5	3800972018464

## CORDLESS HEX IMPACT DRIVER SOLO RDP-SHID20

[BG] Винтоверт ударен акумулаторен без батерия и зарядно • [RO] Surubelnita cu impact fara baterie si incarcator • [SR] Odvijač bez baterija i punjač • [MK] Батериска штрафилица без батерия и полнач • [RU] Аккумуляторная отвёртка без аккумулятора и зарядного устройства • [SL] Akumulatorski izvijač zavijake brez baterije in polnilnika • [EL] Δραπανοκατσαβίδο χωρίς μπαταρία και φορτιστή • [HR] Akumulatorska odvijač bez baterije i punjača • [FR] Perceuse sans fil sans batterie et chargeur • [IT] Trapano senza cordone senza batteria e caricabatterie • [ES] Taladro inalámbrico sin batería y cargador • [PT] Aparafusadora de impacto/caixa a bateria

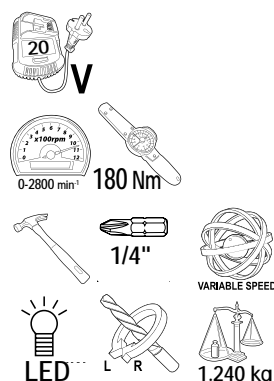

**METAL  
GEAR BOX**



### RDP-SHID20 SOLO

Art.No	gross weight	in cartoon	barcode
030132	1.580 kg	5 pcs	3800123168192

## CORDLESS IMPACT WRENCH SOLO RDP-SCIW20

[BG] Гайкововерт ударен акумулаторен без батерия и зарядно • [RO] Masina de insurubat cu impact fara baterie si incarcator • [SR] Bušilica bez baterija i punjač • [MK] Батериска бормашина без батерия и полнач • [RU] Аккумуляторная дрель без аккумулятора и зарядного устройства • [SL] Akumulatorski vrtalnik vijacnik brez baterije in polnilnika • [EL] Δραπανοκατσαβίδο χωρίς μπαταρία και φορτιστή • [HR] Akumulatorska bušilicabez baterije i punjača • [FR] Perceuse sans fil sans batterie et chargeur • [IT] Trapano senza cordone senza batteria e caricabatterie • [ES] Taladro inalámbrico sin batería y cargador • [PT] Aparafusadora de impacto/caixa a bateria

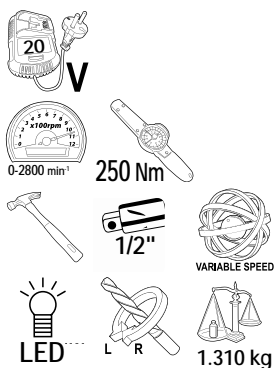

**METAL  
GEAR BOX**



### RDP-SCIW20 SOLO

Art.No	gross weight	in cartoon	barcode
030133	1.640 kg	5 pcs	3800123168215



## CORDLESS IMPACT WRENCH SOLO RDP-SCIW20S

[BG] Гайковерт ударен акумулаторен без батерия и зарядно • [RO] Masina de insurubat cu impact fără baterie și încărcător • [SR] Bušilica bez baterija i punjač • [MK] Батериска бормашина без батерия и полнач • [RU] Аккумуляторная дрель без аккумулятора и зарядного устройства • [SL] Akumulatorski vrtalnik vijacnik brez baterije in polnilnika • [EL] Δραπανοκατασβίδο χωρίς μπαταρία και φορτιστή [HR] Akumulatorska bušilicabez baterije i punjača • [FR] Perceuse sans fil sans batterie et chargeur • [IT] Trapano senza cordone senza batteria e caricabatterie • [ES] Taladro inalambrico sin batería y cargador [PT] Aparafusadora de impacto/caixa a bateria

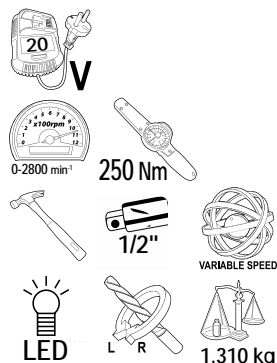

**NEW  
PRODUCT**

**ERGONOMIC  
SOFT HANDLE**
**RDP-SCIW20S SOLO**

Art.No	barcode
030221	3800972017207

## CORDLESS IMPACT WRENCH SOLO RDP-SCIW20-5

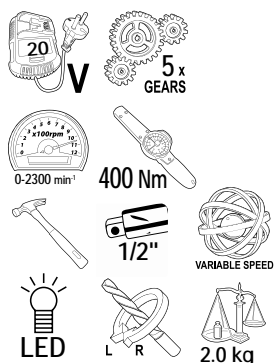
[BG] Гайковерт ударен акумулаторен без батерия и зарядно • [RO] Masina de insurubat cu impact fără baterie și încărcător • [SR] Bušilica bez baterija i punjač • [MK] Батериска бормашина без батерия и полнач [RU] Аккумуляторная дрель без аккумулятора и зарядного устройства • [SL] Akumulatorski vrtalnik vijacnik brez baterije in polnilnika • [EL] Δραπανοκατασβίδο χωρίς μπαταρία και φορτιστή [HR] Akumulatorska bušilicabez baterije i punjača • [FR] Perceuse sans fil sans batterie et chargeur • [IT] Trapano senza cordone senza batteria e caricabatterie • [ES] Taladro inalambrico sin batería y cargador [PT] Aparafusadora de impacto/caixa a bateria

**METAL  
GEAR BOX**

**ELECTRONIC TORQUE  
CONTROL**

**ERGONOMIC  
SOFT HANDLE**
**RDP-SCIW20-5 SOLO**

Art.No	gross weight	in carton	barcode
030134	2.250 kg	5 pcs	3800123168253

## BRUSHLESS CORDLESS ROTARY HAMMER SOLO RDP-SBRH20

[BG] Перфоратор акумулаторен безчетков без батерия и зарядно • [RO] Ciocan rotorpercutor fără baterie și încărcător • [SR] Bežični čekić za vuču bez baterija i punjač • [MK] Батериски ротирачки чекан без батерия и полнач • [RU] Аккумуляторный поворотный молоток без аккумулятора и зарядного устройства • [SL] Brezžični vrtljivi kladivi brez baterije in polnilnika • [EL] Περιστρεφόμενο σφύρι χωρίς μπαταρία και φορτιστή • [HR] Bežični okretni čekić bez baterije i punjača • [FR] Marteau rotatif sans fil sans batterie et chargeur • [IT] Martello perforatore senza batteria e caricabatterie • [ES] Senorda rotaciona martelo sin batería y cargador • [PT] Martelo perfurador a bateria

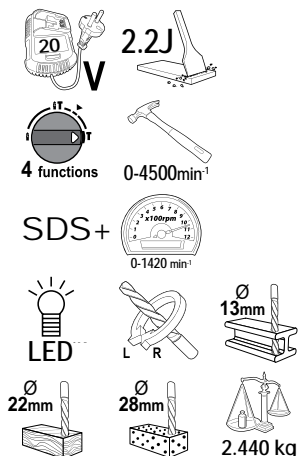
**BRUSHLESS**

**SDS+**

**FOUR FUNCTION**
**RDP-SBRH20 SOLO**

Art.No	gross weight	in carton	barcode
030151	2.710 kg	8	3800972012349



# CORDLESS ROTARY HAMMER

RDP-SRH20 SOLO

ART. NO. 030135

EAN 13: 3800123168239



1.2J



2 functions

SDS+



0-5000min<sup>-1</sup>



0-900 min<sup>-1</sup>



VARIABLE SPEED



LED



L R



1.650 kg

R20 SYSTEM

PRO & POWER TOOLS

PNEUMATICS

ACCESSORIES





## CORDLESS HANDLE MIXER SOLO RDP-SHM20

[BG] Акумулаторен миксер без батерия и зарядно • [RO] Amestecator fără baterie și încărcător • [SR] Mešač bez baterija i punjač • [MK] Мешалка без батерија и полнач • [RU] Перемешиватель без аккумулятора и зарядного устройства • [SL] Mešalnik brez baterije in polnilnika • [EL] Δραπάνο Αναδευτήρας σφύρι χωρίς μπαταρία και φορτιστή • [HR] Miješalica bez baterije i punjača • [FR] Mélangeur à poignée fil sans batterie et chargeur • [IT] Maneggiare il mixer senza batteria e caricabatterie • [ES] Manlibro miksaño sin batería y cargador • [PT] Misturadora manual

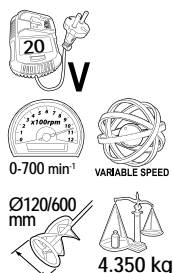
**NEW  
PRODUCT**

**VARIABLE SPEED**

**ERGONOMIC  
SOFT HANDLE**

### RDP-SHM20 SOLO

Art.No	gross weight	in cartoon	barcode
030152	4.850 kg	2 pcs	3800972014282

## CORDLESS JIG SAW RDP-SJS20

[BG] Проболен трион акумулаторен • [RO] Ferstrau pendular • [SR] Ubodna testera sa akumulatorom • [MK] Акумулаторска убодна пила • [RU] Аккумуляторный лобзик • [SL] Akumulatorska vobodna žaga • [EL] Σέγα μπαταρίας • [HR] Akumulatorska ubodna pila • [FR] Scie sauteuse sans fil • [IT] Seghetto alternativo • [ES] Inalámbrico jigsaw • [PT] Rebarbadora com bateria

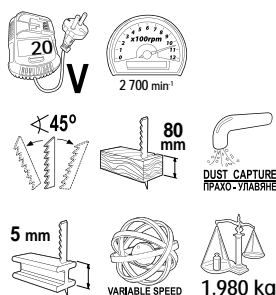
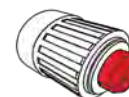
**PENDULUM FUNCTION**

**QUICK CHANGE SYSTEM**

### RDP-SJS20 SOLO

Art.No	gross weight	in cartoon	barcode
030137	2.200 kg	5 pcs	3800123168246

### RDP-SJS20 WITH 1 BATTERY 2Ah SET IN CASE

Art.No	gross weight	in cartoon	barcode
030210	3.100 kg	4 pcs	3800972005365

## CORDLESS RECIPROCATING SAW SOLO RDP-SRS20

[BG] Акумулаторен саблевиден трион без батерия и зарядно • [RO] Ferastrau tip sabie fără baterie și încărcător • [SR] Sabljasta testera batteri bez baterija i punjač • [MK] Акумулаторска пила сабјарка без батерија и полнач • [RU] Аккумуляторен маятниковый лобзик без аккумулятора и зарядного устройства • [SL] Brezžični nihajna vobodna žaga brez baterije in polnilnika • [EL] Πριονί σεγα χωρίς μπαταρία και φορτιστή • [HR] Bežični recipročna pila bez baterije i punjača • [FR] Scie alternative sans fil sans batterie et chargeur • [IT] Sega alternativa senza batteria e caricabatterie • [ES] Sierra reciproca inalambrica sin batería y cargador • [PT] Serra sabre sem bateria e carregador

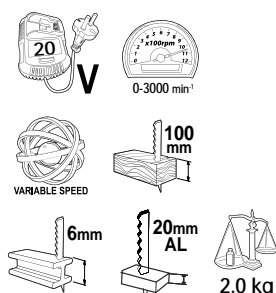
**22cm  
SAW BLADE STROKE**

**QUICK CHANGE SYSTEM**

### RDP-SRS20 SOLO

Art.No	gross weight	in cartoon	barcode
030138	2.230 kg	4 pcs	3800123168260

# CORDLESS ANGLE GRINDER

**RDP-SAG20 WITH 1 BATTERY 2AH SET IN CASE**

ART. NO. 030209

EAN 13: 3800972005358



22.2 mm

125 mm



10 000 min<sup>-1</sup>



2.380 kg

**M14**



**RDP-SAG20 SOLO**

ART. NO. 030136

EAN 13: 3800123168154

ACCESSORIES PNEUMATICS PRO & POWER TOOLS R20 SYSTEM



## BRUSHLESS CORDLESS ANGLE GRINDER RDP-SBAG20

[BG] Ъглошлайф акумулаторен безчетков • [RO] Polizor unghiular • [SR] Brusilica ugaona sa akumulatorom • [MK] Батериска брусилка • [RU] Аккумуляторная угловая шлифовальная машина • [SL] Kotni brusilnik • [EL] Γωνιακος τροχος μπαταριας • [HR] Aku kutna brusilica • [FR] Meuleuse d'angle sans • [IT] Smerigliatrice angolare • [ES] Amoladora angular • [PT] Rebarbadora

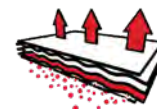
**NEW  
PRODUCT**
**BRUSHLESS**

**DUST FILTER**

**RDP-SBAG20 SOLO**

Art.No	barcode
030223	3800972017221

**RDP-SBAG20 WITH 1 BATTERY 4Ah SET IN CASE**

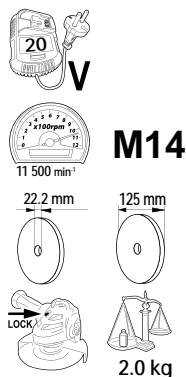
Art.No	barcode
030224	3800972017238



## CORDLESS CIRCULAR SAW SOLO RDP-SCS20

[BG] Циркулар акумулаторен без батерия и зарядно • [RO] Ferastrau circular fără baterie și încărcător • [SR] Bežični cirkular bez baterija i punjač • [MK] Батериски циркулар без батерија и полнач • [RU] Аккумуляторная дисковая пила без аккумулятора и зарядного устройства • [SL] Brezžična krozna zaga brez baterije in polnilnika • [EL] Δισκοπριονο μπαταριας χωρις μπαταρια και φορτιστη • [HR] Aku kružna pila cirkular bez baterije i punjača • [FR] Scie circulaire sans fil sans batterie et chargeur • [IT] Sega circolare cordone senza batteria e caricabatterie • [ES] Sierra circular inalámbrica sin batería y cargador • [PT] Serra circular sem bateria e carregador

**LASER**

**ADJUSTABLE  
CUTTING DEPTH  
AND CUTTING ANGLE 45°**

**RDP-SCS20 SOLO**

Art.No	gross weight	in cartoon	barcode
030139	3.600 kg	2 pcs	3800123168208

**FOR RDP-SCS20**

Art.No	gross weight	in cartoon	barcode
163143	0.240 kg	50 pcs	3800972005396

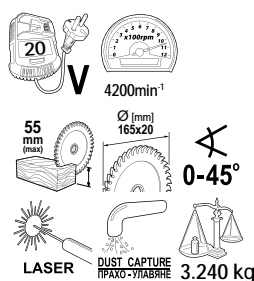

## CORDLESS RANDOM ORBIT SANDER SOLO RDP-SRSA20

[BG] Ексцентършлайф акумулаторен без батерия и зарядно • [RO] Slefuitor orbital fără baterie și încărcător • [SR] Brusilica rotaciona bez baterija i punjač • [MK] Ексцентрична брусилка без батерија и полнач • [RU] Эксцентриковые шлифовальные машины без аккумулятора и зарядного устройства • [SL] Ekscentrični brusilnik brez baterije in polnilnika • [EL] Εκκεντρο τριβειο χωρις μπαταρια και φορτιστη • [HR] Ekscentrična brusilica bez baterije i punjača • [FR] Ponceuse excentrique sans fil sans batterie et chargeur • [IT] Levigatrice orbitale senza batteria e caricabatterie • [ES] Lijadora de órbita inalámbrica sin batería y cargador • [PT] Lixadeira de órbita aleatória sem fio sem bateria e carregador

**VELCRO**

**DUST AWAY**

**RDP-SRSA20**

Art.No	gross weight	in cartoon	barcode
030140	1.200 kg	4 pcs	3800123168161

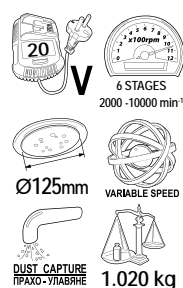

## CORDLESS MULTI-TOOL SOLO RDP-SOMT20

[BG] Многофункционален инструмент без батерия и зарядно • [RO] Unealta multifunctionala fără baterie și încărcător • [SR] Višenamenski alat bez baterija i punjač • [MK] Повеќенаменски алат без батерија и полнач • [RU] Многофункциональный инструмент без аккумулятора и зарядного устройства • [SL] Večnamensko orodje brez baterije in polnilnika • [EL] Πολυεργαλείο μπαταρίας χωρίς μπαταρία και φορτιστή • [HR] Višenamjenski alat bez baterije i punjača • [FR] Outil multifonctionnel sans fil sans batterie et chargeur • [IT] Multi-utensile oscillante senza batteria e caricabatterie • [ES] Herramienta multifuncional inalámbrica sin batería y cargador • [PT] Multi-ferramenta oscilante sem fio sem bateria e carregador

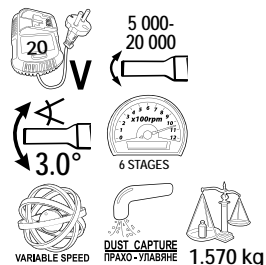

VARIABLE SPEED



QUICK CHANGE



CUTTING AND GRINDING



2 LEDs

### RDP-SOMT20 SOLO

Art.No	gross weight	in cartoon	barcode
030141	1.750 kg	4 pcs	3800123168178

## CORDLESS HOT MELT GLUE GUN SOLO RDP-SGLG20

[BG] Пистолет за топло лепене акумулаторен без батерия и зарядно • [RO] Pistol de lipit fara acumulator si incarcator • [SR] Akumulatorski pištolj za lepljenje bez baterije i punjača • [MK] Безжичен лепак пистолет без батерија и полнач • [RU] Аккумуляторный клеевой пистолет без аккумулятора и зарядного устройства • [SL] Akumulatorska pištola za lepljenje brez baterije in polnilnika • [EL] Επαναφορτιζόμενο πιστόλι κόλλησης χωρίς μπαταρία και φορτιστή • [HR] Akumulatorski pištolj za lijepljenje bez baterije i punjača • [FR] Pistolet à colle sans fil sans batterie et chargeur • [IT] Pistola per colla a batteria senza batteria e caricabatterie • [ES] Pafilata gluilo sen baterio kaj senšargilo sin batería y cargador • [PT] Arma de cola sem fio sem bateria e carregador



DUSE DIAMETER  
Ø 3 mm

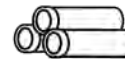

GLUE STICKS  
Ø 11 mm

### RDP-SGLG20 SOLO

Art.No	gross weight	in cartoon	barcode
030154	0.660 kg	4 pcs	3800972014428

## CORDLESS HEAT GUN SOLO RDP-SHG20

[BG] Пистолет за горещ въздух акумулаторен без батерия и зарядно • [RO] Pistol cu aer cald fără baterie și încărcător • [SR] Pištolj za vreli vazduh bez baterije i punjača • [MK] Фен без батерија и полнач • [RU] Пистолет горячего воздуха без аккумулятора и зарядного устройства • [SL] Vroca zrasna pištola brez baterije in polnilnika • [EL] Πιστόλι φερμου αέρα χωρίς μπαταρία και φορτιστή • [HR] Pištolj za vrući zrak bez baterije i punjača • [FR] Arbre à air chaud sans batterie et chargeur • [IT] Pistola aria calda senza batteria e caricabatterie • [ES] Pistola de aire caliente sin batería y cargador • [PT] Soprador de ar quente sem bateria e carregador



0 - 550°C



### RDP-SHG20 SOLO

Art.No	barcode
030160	3800972018884



## CORDLESS COMBI AIR STAPLER AND NAILER SOLO RDP-SST20

[BG] Акумулаторен комбиниран такер без батерия и зарядно • [RO] Capsator fără fir combinat fără baterie și încărcător • [SR] Kombinovani akumulatorski klamerica bez baterije i punjača • [MK] Комбиниран безжичен спојувач без батерија и полнач • [RU] Беспроводной степлер комбинированный без аккумулятора и зарядного устройства • [SL] Kombinirana akumulatorska spenjača brez baterije in polnilnika • [EL] Συρραπτικό συρραπτικό συνδυασμένο μπαταρία και φορτιστή • [HR] Kombinirani bežični klamerica bez baterije i punjača • [FR] Agrafeuse sans fil combinée • [IT] Cucitrice cordless combinata senza batteria e caricabatterie • [ES] Senkabila stapler kombinata sin batería y cargador • [PT] Grampeador sem fio combinado sem bateria e carregador

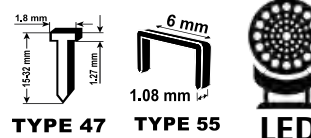
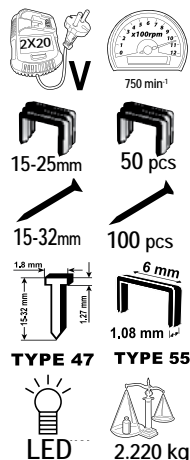

### RDP-SST20 SOLO

Art.No	gross weight	in carton	barcode
030153	2.470 kg	4 pcs	3800972014411

## STAPLES FOR CORDLESS STAPLER RDP-SST20

[BG] Скоби за акумулаторен пневматичен такер • [RO] Capse pentru capsator fără fir RDP-SST20 • [SR] Držači za bežični spenjač RDP-SST20 • [MK] Муниција за хефталка RDP-SST20 • [RU] Скобы для беспроводного степлера RDP-SST20 • [SL] Sponke RDP-SST20 • [EL] Συρραπτικά για ασύρματο συρραπτικό RDP-SST20 • [HR] Klamerice za klamerica RDP-SST20 • [FR] Sauterelles RDP-SST20 • [IT] Morsetti di inclinazione RDP-SST20 • [ES] Grapoj por sendrata stanpilo RDP-SST20 • [PT] Grampos para grampeador sem fio RDP-SST20



Art.No	H (mm)	W (mm)	D (mm)	barcode
511412	14	6	1.08	3800972015661
511413	16	6	1.08	3800972015678
511414	20	6	1.08	3800972015685
511415	25	6	1.08	3800972015692

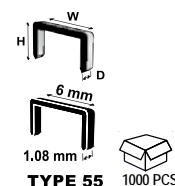

## NAILS FOR CORDLESS STAPLER RDP-SST20

[BG] Пирони за акумулаторен такер • [RO] Cuie pentru capsator fără fir RDP-SST20 • [SR] Klamerice za pneumatsku heftalicu RDP-SST20 • [MK] Муниција за хефталка RDP-SST20 • [RU] Гвозди для беспроводного степлера RDP-SST20 • [SL] Sponke RDP-SST20 • [EL] Καρφιά για ασύρματο συρραπτικό RDP-SST20 • [HR] Klamerice za RDP-SST20 • [FR] Sauterelles RDP-SST20 • [IT] Morsetti di inclinazione RDP-SST20 • [ES] Ślosiljoj por sendrata grapilo RDP-SST20 • [PT] Pregos para grampeador sem fio RDP-SST20



Art.No	H (mm)	D (mm)	barcode
511416	15	1.08	3800972015708
511417	20	1.08	3800972015715
511418	25	1.08	3800972015722
511419	32	1.08	3800972015739

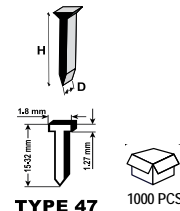

## CORDLESS SPRAY GUN SOLO RDP-SSGC20

[BG] Пистолет за боя без батерия и зарядно • [RO] Pistol de pulverizare fără acumulator și încărcător [SR] Akumulatorski pištolj za prskanje bez baterija i punjač • [MK] Безжичен пиштол без батерија и полнач • [RU] Аккумуляторный пистолет без аккумулятора и зарядного устройства • [SL] Akumulatorska brizgalna pištola brez baterije in polnilnika • [EL] Ακουστικό ψεκαστήρα χωρίς μπαταρία και φορτιστή • [HR] Akumulatorski pištolj za prskanje bez baterije i punjača • [FR] Pistolet sans fil sans batterie et chargeur • [IT] Pistola a batteria senza batteria e caricatore • [ES] Śnurfunda pistolo sen baterio kaj senšargilo [PT] Pistolet sans fil sans batterie et chargeur

**NEW PRODUCT**

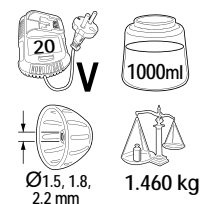

## NOZZLES & FILTERS SET FOR CORDLESS SPRAY GUN RDP-SSGC20



**CONTAINER CAPACITY**  
1000 ml

**DUSE DIAMETER**  
Ø 1.5, 1.8, 2.2 mm

### RDP-SSGC20 SOLO

Art.No	gross weight	in carton	barcode
074202	1.620 kg	4	3800972014770

### NOZZLES AND FILTERS FOR RDP-SSGC20

Art.No	gross weight	in carton	barcode
110914	0.070 kg	300	3800972015906

## BRUSHLESS CORDLESS BRUSH CUTTER WITH BLADE AND TRIMMER HEAD DETACHABLE SHAFT RDP-SBBC20 SET

[BG] Коса акумулаторна безчеткова с нож и корда сгъваема • [RO] Cuțit fără perii cu lamă și cap de tuns • [SR] Akumulatorski bezžičen sekač so sečiloto i glava • [MK] Безжичен секач со сечилото и глава • [RU] Аккумуляторный кусторез с лезвием и триммерной головкой • [SL] Akumulatorski rezalnik ščetk z rezilom in glavo trimera • [EL] Επαναφορτιζόμενη βούρτστα με λεπίδα και κεφαλή κοπής • [HR] Akumulatorski rezač četka s oštricom i trimer glavom • [FR] Débroussaillse sans fil avec lame et tête de coupe • [IT] Decespugliatore a batteria con lama e testa di rifinitura • [ES] Senfunda trançila brotilo kun klingo kaj tondanta kapo • [PT] Roçadeira sem fio com lâmina e cabeça de corte

**NEW  
PRODUCT**

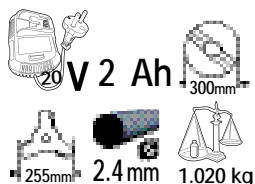

**BRUSHLESS**



**CUTTING  
DIAMETER  
WITH CORD  
300 mm**



**CUTTING  
DIAMETER  
WITH BLADE  
255 mm**

**RDP-SBBC20 WITH 1 BATTERY 2Ah SET**

Art.No	barcode
075711	3800972016668

## POLE SAW HEAD WITH TUBE FOR RDP-SBBC20

[BG] Кастрачка • [RO] Capul de ferăstrău pol cu tub • [SR] Polna testera • [MK] Пољакот виде глава • [RU] Полюс увидел голову с трубкой • [SL] Glava žaga za sevno • [EL] Ο πόλος είδε το κεφάλι με σωλήνα • [HR] Poljak vidio • [FR] Scie à perche • [IT] Palo vide • [ES] Poluso vidis • [PT] Serra de poste

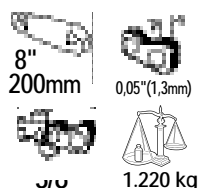

Art.No	barcode
075712	3800972016675

## HEDGE TRIMMER HEAD WITH TUBE FOR RDP-SBBC20

[BG] Резачка за храсти • [RO] Cap de tuns cu balamuc cu tub • [SR] Glava trimera za živice sa cevkom • [MK] Тример за сечење на храст • [RU] Головка триммера • [SL] Glava škarje za živo mejo • [EL] Κεφαλή κοπής φρακτών • [HR] Glava trimera za živicu • [FR] Tête de taille-haie • [IT] Testa del tagliasiepi • [ES] Tondilo de hego • [PT] Aparador de cerca viva



Art.No	barcode
075713	3800972016682



## CORDLESS BRUSH CUTTER SOLO RDP-SCBC20

[BG] Коса акумулаторна без батерия и зарядно • [RO] Cuțit pentru tăietori fără perii fără baterie și încărcător • [SR] Akumulatorski rezač četki bez baterije i punjača • [MK] Безжичен трева машина без батерија и полнач • [RU] Аккумуляторная косилка без аккумулятора и зарядного устройства • [SL] Akumulatorska kosilka brez baterije in polnilnika • [EL] Χλοοκοπτικό χωρίς μπαταρία και φορτιστή • [HR] Akumulatorske kosilice bez baterije i punjača • [FR] Tondeuse à gazon sans batterie et chargeur • [IT] Tosaerba senza batteria e caricabatterie • [ES] Gazontondilo sin batería y cargador • [PT] Corta relvas sem bateria e carregador

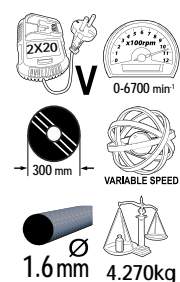

**CUTTING  
DIAMETER  
WITH CORD  
300 mm**

**RDP-SCBC20 SOLO**

Art.No	gross weight	in cartoon	barcode
075545	4.750 kg	2 pcs	3800972014671



### CORDLESS LAWN MOWER SOLO RDP-SLM20

[BG] Акумулаторна косачка без батерия и зарядно • [RO] Mașină de tuns iarba fără baterie și încărcător • [SR] Kosilica za travu bez baterije i punjača • [MK] Батериска косилка за трева без батерија и полнач • [RU] Акумулаторная косилка без аккумулятора и зарядного устройства • [SL] Akumulatorska kosilka brez baterije in polnilnika • [EL] Χλοοκοπτικό χωρίς μπαταρία και φορτιστή • [HR] Akumulatorske kosilice bez baterije i punjača • [FR] Tondeuse à gazon sans batterie et chargeur • [IT] Tosaerba senza batteria e caricabatterie • [ES] Gazontondilo sin batería y cargador • [PT] Corta relvas sem bateria e carregador

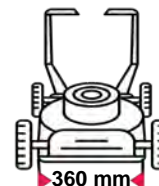

#### RDP-SLM20 SOLO

Art.No	gross weight	in cartoon	barcode
075328	12.500 kg		3800972009448

#### FOR RDP-SLM20 SOLO

Art.No	gross weight	in cartoon	barcode
110278	0.500 kg		3800972010451

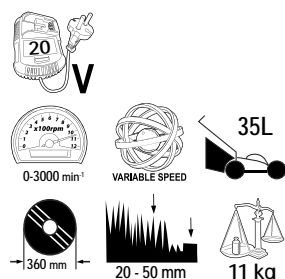

### CORDLESS HEDGE TRIMMER SOLO RDP-SCHT20

[BG] Резачка за храсти без батерия и зарядно • [RO] Trimmer pt. gard fără baterie și încărcător • [SR] Bežični trimer za živu ogradu bez baterija i punjač • [MK] Бежичен тример со жива хец без батерија и полнач • [RU] Акумулаторный кусторез без аккумулятора и зарядного устройства • [SL] Akumulatorski škarje za živo mejo brez baterije in polnilnika • [EL] Ασύρματο φτερό φρένων μπαταρία και φορτιστή • [HR] Akumulatorski trimer za živu ogradu bez baterije i punjača • [FR] Taille-haie sans fil sans batterie et chargeur • [IT] Tagliasiepi a batteria senza batteria e caricabatterie • [ES] Senkbla heñezezurilo sin batería y cargador • [PT] Corta-sebes sem bateria e carregador

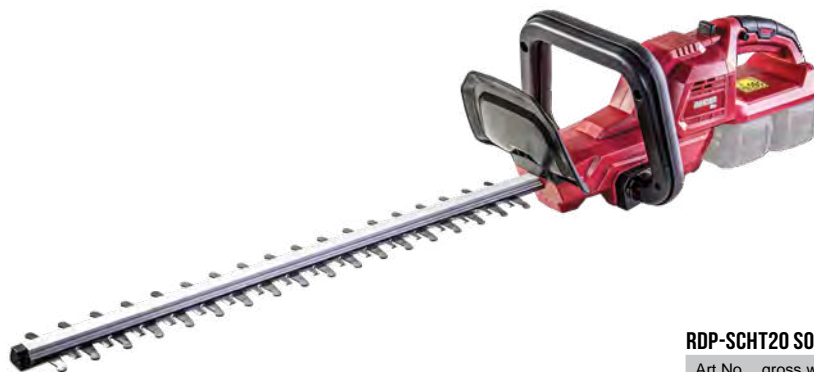

#### RDP-SCHT20 SOLO

Art.No	gross weight	in cartoon	barcode
075707	4.650 kg	2 pcs	3800972014688

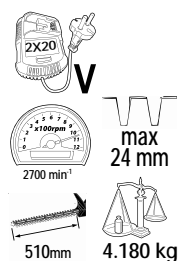

### CORDLESS SOLO RDP-PSH01

[BG] Ножица лозарска акум. • [RO] Foarfeca de gradina • [SR] Makaze voćarske • [MK] Градинарски ножици • [RU] Садовые ножницы • [SL] Vrtnе škarje • [EL] Ψαλίδι κλαδέματος • [HR] Makaze • [FR] Cisailles d'égagage • [IT] Cesioie • [ES] • [PT] Tesoura de jardim

**BRUSHLESS**



Art.No	gross weight	in cartoon	barcode
075714	4.650 kg	2 pcs	3800972016699

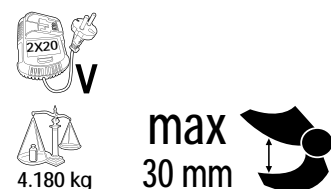

## CORDLESS POLE SAW RDP-SPS20 SET

[BG] Кастрачка акумулаторна • [RO] Fierăstrău de stâlp fără fir • [SR] Akumulatorska polovna testera • [MK] Бежичена тестера • [RU] Аккумуляторный кусторез • [SL] Akumulatorski škarje  
[EL] Ασύρματο πριόνι • [HR] Akumulatorska pila • [FR] Scie à perche sans fil • [IT] Sega polare a batteria • [ES] Senmova stangeto vidis • [PT] Serra sem fio

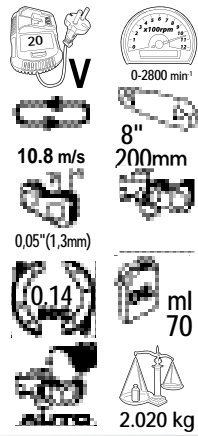

**NEW  
PRODUCT**



### RDP-SPS20 WITH 1 BATTERY 2Ah SET

Art.No	barcode
075708	3800972016637

## CORDLESS CHAIN SAW WITHOUT BATTERY AND CHARGER RDP-SCS20

[BG] Резачка акумулаторна • [RO] Ferăstrăie fără fir • [SR] Akumulatorska motorna testera • [MK] Бежичена тестера • [RU] Аккумуляторная цепная пила • [SL] Brezžična motorna žaga  
[EL] Επαναφορτιζόμενο αλυσοπριόνιο • [HR] Akumulatorska motorna pila • [FR] Scie sans fil • [IT] Sega a batteria • [ES] Sendrata sego • [PT] Serra sem fio

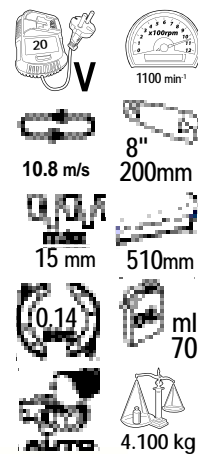

**NEW  
PRODUCT**



RDP-SCS20 SET

+



**CHARGING TIME  
1 HOUR**



**OREGON GUIDE  
BAR AND CHAIN**



**ERGONOMIC  
HANDLE**

### RDP-SCS20 SOLO

Art.No	barcode
075710	3800972016651

### RDP-SCS20 WITH 1 BATTERIES 3Ah SET

Art.No	barcode
075709	3800972016644

## CORDLESS CHAIN SAW

**BRUSHLESS**

## RDP-SBCS20



- [BG] Резачка безчеткова акумулаторна без батерия и зарядно
- [RO] Fierastrau cu lant fara acumulator si incarcator
- [SR] Akumulatorska motorna testera bez baterija i punjač
- [MK] Бежичен моторна пила без батерија и полнач
- [RU] Аккумуляторная цепная пила без аккумулятора и зарядного устройства
- [SL] Brezžična motorna žaga brez baterije in polnilnika
- [EL] Επαναφορτιζόμενο αλυσοπριόνιο χωρίς μπαταρία και φορτιστή
- [HR] Akumulatorska motorna pila bez baterije i punjača
- [FR] Scie à chaîne sans fil sans batterie et chargeur
- [IT] Motosega a batteria senza batteria e caricabatterie
- [ES] Cenvojo sin batería y cargador
- [PT] Motosserra sem bateria e carregador



**OREGON**

### RDP-SBCS20 SOLO

Art.No	gross weight	in cartoon	barcode
030155	4.800 kg	2 pcs	3800972014435



### WET & DRY VACUUM CLEANER SOLO RDP-SDWC20

[BG] Прахосмукачка за сухо и мокро • [RO] Aspirator umed/uscat fara acumulator si incarcator  
 [SR] Usisivača za mokro i suvo [MK] Правосмукалка за суво и мокро • [RU] Мокрый и сухой пылесос  
 [SL] Sesalnik za mokro in suho • [EL] Ηλεκτρική σκούπα για υγρή και ξηρή  
 [HR] Usisivač za mokre i suhe podloge • [FR] Aspirateur • [IT] Aspirapolvere  
 [ES] Polvosuñilo • [PT] Aspirador "WET & DRY"

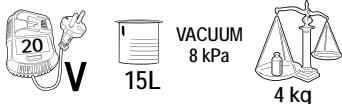

#### RDP-SDWC20 SOLO

Art.No	gross weight	in carton	barcode
090319	4.900 kg	1	3800972015883

### ASH VACUUM CLEANER SOLO RDP-SWC20

[BG] Прахосмукачка за пепел • [RO] Aspirator pentru cenusa fara acumulator si incarcator  
 [SR] Usisivač za pepeo [MK] Правосмукалка за пепел • [RU] Пепла пылесос  
 [SL] Sesalnik pepela • [EL] Σκούπα φίλτρο σταχτήρ • [HR] Usisivač za uklanjanje pepela  
 [FR] Aspirateur de cendre • [IT] Aspirapolvere per cenere  
 [ES] Ash malplena • [PT] Aspirador de cinzas

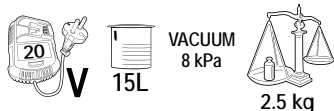

#### RDP-SWC20 SOLO

Art.No	gross weight	in carton	barcode
090315	3.500 kg	1	3800972015845

#### HEPA FILTER FOR RD-WC06, RDP-SWC20

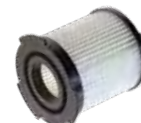

Art.No	gross weight	in carton	barcode
090320	0.280 kg	24 pcs	3800972015890



ONE BATTERY  
**FITS**  
**ALL**

### SYSTEM STARTER KIT RDP-R20 SYSTEM

[BG] Комплект батерия и зарядно • [RO] Set acumulator si incarcator • [SR] Set baterija i punjač • [MK] Батерија и полнач сет • [RU] Аккумулятор и зарядное устройство сет  
 [SL] Baterija iv polnilec baterij set • [EL] Μπαταρία και φορτιστή σελ • [HR] Baterije i punjača set • [FR] Batterie et chargeur set • [IT] Batteria e caricabatterie set • [ES] Batería y cargador set  
 [PT] Bateria e carregador set

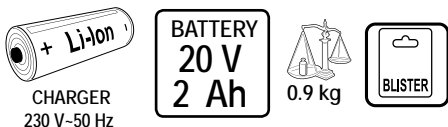

Art.No	gross weight	in carton	barcode
032120	0.980 kg	4 pcs	3800123168307

## BATTERY PACK RDP-R20 SYSTEM

[BG] Батерия • [RO] Acumulator • [SR] Baterija • [MK] Батерија • [RU] Аккумулятор • [SL] Baterija • [EL] Μπαταρία • [HR] Baterija • [FR] Batterie • [IT] Batteria • [ES] Batería • [PT] Bateria

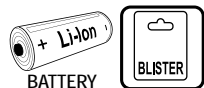

Art.No	V	Ah	net weightkg	gross weight	in cartoon	barcode
131110	20	1.5	0.400	0.550	10 pcs	3800123168284
131152	20	2	0.700	0.860	10 pcs	3800972005310
131159	20	3	0.730	0.800	10 pcs	3800972017245
131153	20	4	0.760	0.850	10 pcs	3800972005327



Art.No	V	Ah	net weightkg	gross weight	in cartoon	barcode
131161	20	6	0.900	0.960	10 pcs	3800972014718



## CHARGER RDP-R20 SYSTEM

[BG] Зарядно • [RO] Incarcator • [SR] Punjač • [MK] Полнач на батерии • [RU] Зарядное устройство • [SL] Polnilnik baterij • [EL] Φορτιστής μπαταρίας • [HR] Punjač baterije • [FR] Chargeur de batterie • [IT] Caricabatteria • [ES] Cargador de batería • [PT] Carregador de bateria



Art.No	Ah	net weightkg	gross weight	in cartoon	barcode
039703	2.4	0.450	0.500	10 pcs	3800123168291
039704*	3.5	0.500	0.550	10 pcs	3800972005334

\* [BG] Бързо зарядно • [RO] Incarcator rapid • [SR] Buzri punjač • [MK] Брз полнач на батерии • [RU] Быстрое зарядное устройство • [SL] Hiter polnilnik baterij • [EL] Γρήγορο φορτιστή μπαταρίας • [HR] Brzo punjač baterije • [FR] Chargeur rapide de batterie • [IT] Caricatore rapido • [ES] Cargador rápido de batería • [PT] Carregador rápido de bateria

## DUAL CHARGER RDP-R20 SYSTEM

[BG] Зарядно двойно • [RO] Incarcator dual • [SR] Dvojni punjač • [MK] Двоен полнач на батерии • [RU] Двойное зарядное устройство • [SL] Dvojni polnilnik • [EL] Διπλό φορτιστή • [HR] Dvostruki punjač • [FR] Double chargeur • [IT] Caricatore doppio • [ES] Duobla šargilo • [PT] Carregador duplo

2 x 3A

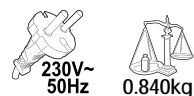

Art.No	net weightkg	gross weight	in cartoon	barcode
039707	0.900	0.940	10 pcs	3800972014459



## ADAPTER USB WITH LAMP FOR SERIES R20 SOLO

[BG] Адаптор USB с лампа • [RO] Adaptor USB • [SR] Adapter USB sa lampom • [MK] Адаптер USB со светилка • [RU] Адаптер USB с лампой • [SL] Adapter USB z žarnico • [EL] Προσαρμογέας USB με λάμπα • [HR] USB adapter s lampom • [FR] Adaptateur USB avec lampe • [IT] Adattatore USB con lampada • [ES] Adaptilo USB kun lampo • [PT] Adaptador USB com lâmpada

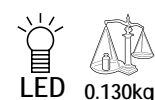

Art.No	net weightkg	gross weight	in cartoon	barcode
039706	0.130	0.150	50 pcs	3800972014442





# CORDLESS DRILL

- [BG] Акумулаторна бормашина • [RO] Masina de gaurit si insurubat
- [SR] Vušilica • [MK] Батериска бормашина • [RU] Аккумуляторная дрель
- [SL] Akumulatorski vrtalnik vijasnik • [EL] Δραπανοκατασφίδο
- [HR] Akumulatorska bušilica • [FR] Perceuse sans fil
- [IT] Trapano senza cordone • [ES] Taladro inalambrico sin batería y cargado
- [PT] Aparafusadora



2x  
GEARS



26 Nm

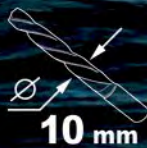

10 mm



1.5 Ah

**RDP-CDL30**

**12 V**



• Art.No 030214

• Barcode: 3800972016491

# IMPACT DRILL

- [BG] Бормашина • [RO] Bormasina • [SR] Vušilica • [MK] Бормашина
- [RU] Дрель • [SL] Vrtalnik • [EL] Κρουστικό δραπανο • [HR] Vušilica
- [FR] Perceuse • [IT] Trapano • [ES] Taladro • [PT] Aparafusado



230V~  
50Hz



10 mm



450 W



25 mm



0-2800min<sup>-1</sup>



L R



1.5-10 mm

**RDP-ID43**

**450 W**



• Art.No 010202

• Barcode: 3800972015371



230V~  
50Hz



13 mm



910 W



16 mm



0-2800min<sup>-1</sup>



25 mm



1.5-13 mm



L R

**RDP-ID42**

**910 W**



• Art.No 010201

• Barcode: 3800972015364



BLACK  
EDITION

# ANGLE GRINDER

- [BG] Ъглошлайф • [RO] Polizor unghiular
- [SR] Brusilica ugazona • [MK] Брусилка
- [RU] Угловая шлифовальная машина • [SL] Kotni brusilnik
- [EL] Κρούστικό άκρατο • [HR] Kutna brusilica • [FR] Meuleuse à angle
- [IT] Smerigliatrice angolare • [ES] Angulo muelilo • [PT] Rebarbadora



- Art.No 020143
- Barcode: 3800123166839



- Art.No 020144
- Barcode: 3800123166822



230V~  
50Hz



750 W 11000 min<sup>-1</sup>

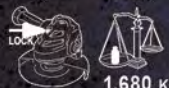

1.680 KG

**RDP-AG42**  
**750 W**



230V~  
50Hz



910 W 6000 min<sup>-1</sup>  
-12000



2.000 KG

**RDP-AG43**  
**910 W**

R20 SYSTEM

PRO & POWER TOOLS

PNEUMATICS

ACCESSORIES





230V~  
50Hz



900 W 11000 min<sup>-1</sup>



2.320 KG

**RDP-AG62**  
**900 W**



- Art.No 020302
- Barcode: 3800972015128



230V~  
50Hz



1200 W 9000 min<sup>-1</sup>



2.890 KG

**RDP-AG63**  
**1200 W**

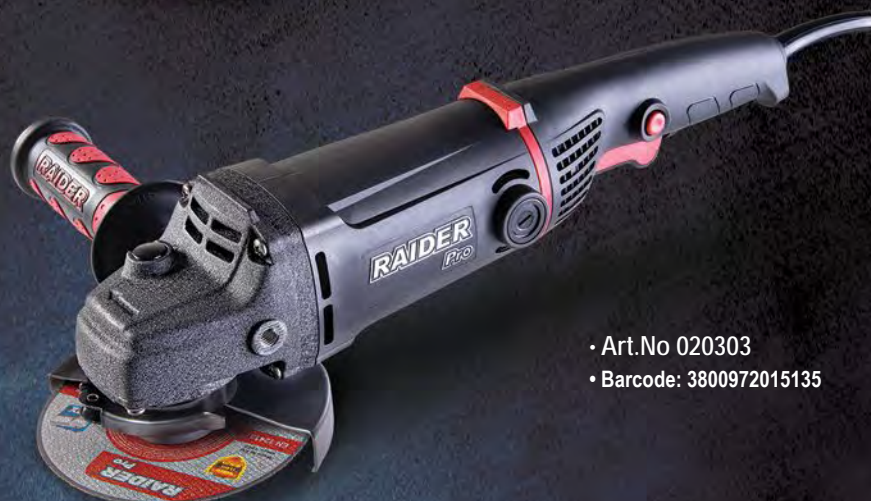

- Art.No 020303
- Barcode: 3800972015135



230V~  
50Hz



1500 W 2500 min<sup>-1</sup>  
-9000



3.220 KG

**RDP-AG64**  
**1500 W**



- Art.No 020304
- Barcode: 3800972015142



230V~  
50Hz



2400W 6500 min<sup>-1</sup>



6.720 KG

**RDP-AG65**  
**2400 W**



- Art.No 020401
- Barcode: 3800972015159



# RAIDER®

**Power Tools  
Pro**





# CORDLESS SCREWDRIVER

[BG] Отвертка акумулаторна • [RO] Surubelnita cu acumulator • [SR] Akumulatorski odvrtac • [MK] Акумулаторски одвртувач • [RU] Аккумуляторная отвертка • [SL] Akumulatorski vijacnik • [EL] Κατσαβίδι μπαταρίας • [HR] Akumulatorski odvijač • [FR] Tournevis sans fil • [IT] Cacciavite a batteria • [ES] Senkabila śraūbilo • [PT] Aparafusadora

## RD-CSCLO4

**3.6 V** **LITHIUM-ION**

3.6 V	CHARGING TIME 3-5 h	800 mAh Li-Ion
250 min <sup>-1</sup>		
LED	0.450 kg	COLOR BOX

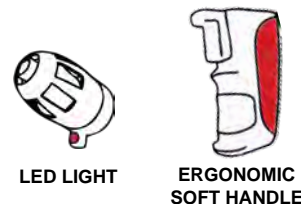

Art.No	gross weight	in cartoon	barcode
031201	0.500 kg	20 pcs	3800972001558

## RDP-CSCLO1

**3.6 V** **LITHIUM-ION**

3.6 V	1300 mAh	180 min <sup>-1</sup>
5 Nm	16 + 1	
CHARGING TIME 3h	VARIABLE SPEED	0.720 kg



Art.No	gross weight	in cartoon	barcode
031106	0.800 kg	10 pcs	3800123162305

## RDP-CSCLO3

**3.6 V** **LITHIUM-ION**

- ALUMINIUM CASE
- 1pcs 25mm AD holder
- 1pcs 50mm AD holder
- 1pc magnetic bit holder 60mm
- 99PCS 25mm screwdriver bits(material: carbon steel)

3.6 V	1300 mAh	180 min <sup>-1</sup>
4 Nm	102 pcs	
CHARGING TIME 3h	10 + 1	1.500 kg



ALUMINIUM CASE

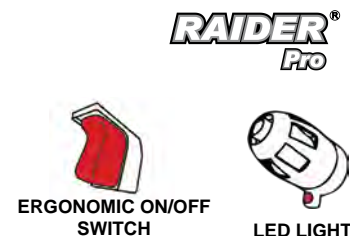

Art.No	gross weight	in cartoon	barcode
031128	1.670 kg	10 pcs	3800123169526

## REVOLVER CORDLESS SCREWDRIVER RDP-CSCLO2

[BG] Отвертка акумулаторна револверна • [RO] Surubelnita cu acumulator • [SR] Akumulatorski odvrtac • [MK] Акумулаторски одвртувач • [RU] Аккумуляторная отвертка • [SL] Akumulatorski vijacnik • [EL] Κατσαβίδι μπαταρίας • [HR] Akumulatorski odvijač • [FR] Tournevis sans fil revolver • [IT] Giravite a batteria revolver • [ES] Ruliği senkablán śraūbkanilon • [PT] Aparafusadora

**3.6 V** **LITHIUM-ION**

3.6 V	1300 mAh	180 min <sup>-1</sup>
4 Nm	x56	
CHARGING TIME 3h	1.020 kg	



Art.No	gross weight	in cartoon	barcode
031107	1.130 kg	6 pcs	3800123166150

# CORDLESS DRILL

• [BG] Акумулаторна бормашина • [RO] Bormașină cu acumulator • [SR] Bušilica sa akumulatorom • [MK] Батериска бормашина • [RU] Аккумуляторная дрель  
 • [SL] Akumulatorski vrtnik vijasnik • [EL] Τρυπάνι Μ Συσσωρυτή • [HR] Akumulatorska bušilica • [FR] Perceuse sans fil avec batterie et chargeur  
 • [IT] Trapano senza cordone con batteria e caricabatterie • [ES] Taladro inalámbrico con batería y cargador • [PT] Aparafusadora

## RDP-CDL03L RAIDER<sup>®</sup> Pro

12 V LITHIUM-ION

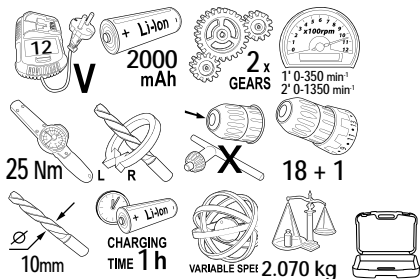

### LED CORDLESS WORKING LIGHT RDP-CDL03L



Art.No	gross weight	in cartoon	barcode
039913	0.100	50 pcs	3800123167041

### BATTERY FOR CORDLESS DRILL LI-ION

art. №	V	Ah	barcode
131132	12	2	3800123167072

### CHARGER FOR CORDLESS DRILL LI-ION

art. №	V	charge time	barcode
032110	230	1 h	3800123167140

## RDP-CDL08L RAIDER<sup>®</sup> Pro

12 V LITHIUM-ION

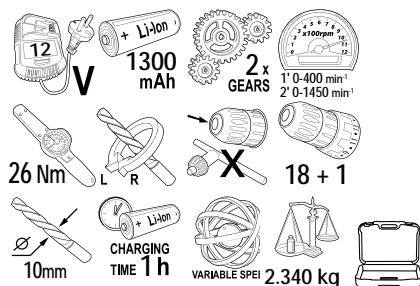

CHARGING TIME  
1 HOUR

Art.No	gross weight	in cartoon	barcode
030123	2.600 kg	5 pcs	3800123167058

### BATTERY FOR CORDLESS DRILL LI-ION



art. №	V	Ah	barcode
131133	12	2	3800123167089

### CHARGER FOR CORDLESS DRILL LI-ION



art. №	V	charge time	barcode
032111	230	1 h	3800123167157

## RDP-CDL21 RAIDER<sup>®</sup> Pro

20 V LITHIUM-ION

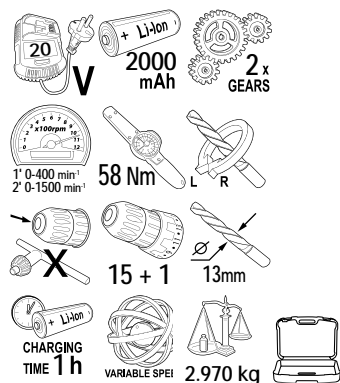

2  
BATTERIES

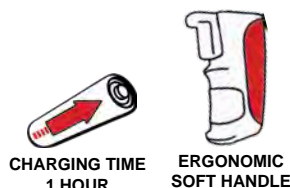

CHARGING TIME  
1 HOUR

ERGONOMIC  
SOFT HANDLE

Art.No	gross weight	in cartoon	barcode
030207	3.300 kg	5 pcs	3800972004764

### BATTERY FOR CORDLESS DRILL LI-ION



art. №	V	Ah	barcode
131151	20	2	3800972005082

### CHARGER FOR CORDLESS DRILL LI-ION



art. №	V	barcode
039702	230	3800972004818

## ECCENTRIC ADAPTOR QUICK CHANGE FOR RDP-CDL21

Art. N 139007  
EAN: 3800972015173



## ANGLE ADAPTOR QUICK CHANGE FOR RDP-CDL21

Art. N 139005  
EAN: 3800972014568



## DRILL CHUCK FOR RDP-CDL21

Art. N 139006  
EAN: 3800972014572





# CORDLESS DRILL

[BG] Акумулаторна бормашина • [RO] Bormașină cu acumulator • [SR] Bușilica sa akumulatorom • [MK] Батериска бормашина • [RU] Аккумуляторная дрель • [SL] Akumulatorski vrtnik vijacnik • [EL] Τρυπάνω Μ Συσσωρευτή • [HR] Akumulatorska bušilica • [FR] Perceuse sans fil avec batterie et chargeur • [IT] Trapano senza cordone con batteria e caricabatterie • [ES] Taladro inalámbrico con batería y cargador • [PT] Aparafusadora

## RD-CDL27

12 V **LITHIUM-ION**

12 V  
1500 mAh  
Li-Ion  
1' 0-400  
2' 0-1400  
min<sup>-1</sup>

28 Nm  
0.8-10mm  
18+1

2 x GEARS  
LED  
1.9 kg



ACCESSORIES 13pcs:  
•6pcs 25mm screwdriver (PH1, PH2, PZ1, PZ2, 5, 6)  
•6pcs drill (1.5, 2.5, 3, 4, 5, 6)  
•1pc 60mm bits holder

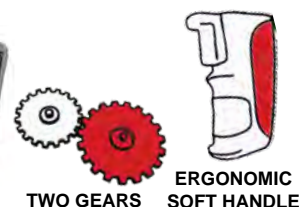

Art.No	gross weight	in cartoon	barcode
030149	2.2 kg	8 pcs	3800972008946

## RD-CDL09T

12 V **LITHIUM-ION** 2 BATTERIES

12 V  
1500 mAh  
Li-Ion  
1' 0-400  
2' 0-1400  
min<sup>-1</sup>

28 Nm  
0.8-10mm  
18+1

2 x GEARS  
LED  
2 kg



ACCESSORIES 13pcs:  
•6pcs 25mm screwdriver (PH1, PH2, PZ1, PZ2, 5, 6)  
•6pcs drill (1.5, 2.5, 3, 4, 5, 6)  
•1pc 60mm bits holder

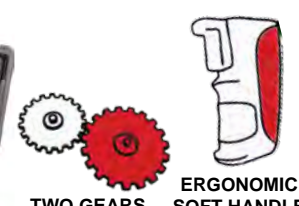

Art.No	gross weight	in cartoon	barcode
030125	2.240 kg	8 pcs	3800123167324

## RD-CDL26

12 V **LITHIUM-ION** 2 BATTERIES

12 V  
1500 mAh  
Li-Ion  
1' 0-400  
2' 0-1400  
min<sup>-1</sup>

28 Nm  
0.8-10mm  
18+1

2 x GEARS  
LED  
0.9 kg



ACCESSORIES 13pcs:  
•6pcs 25mm screwdriver (PH1, PH2, PZ1, PZ2, 5, 6)  
•6pcs drill (1.5, 2.5, 3, 4, 5, 6)  
•1pc 60mm bits holder

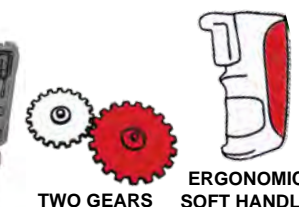

Art.No	gross weight	in cartoon	barcode
030148	1.1 kg	8 pcs	3800872008717

## RATCHET WRENCH RD-RW01

[BG] Трещотка акумулаторна в куфар с аксесоари • [RO] Cheie cu clichet • [SR] Račna sa akumulatorom • [MK] Батериска крцкалка • [RU] Аккумуляторная трещотка • [SL] Akumulatorski ratchet pisemo z dodatki • [EL] Μηχανισμός ratchet με αξεσουάρ • [HR] Akumulatorska račna • [FR] Clé à cliquet avec accessoires • [IT] chiave a cricchetto a batteria con accessori • [ES] Wrench kaj accessorioj • [PT] Aparafusadora

12 V **LITHIUM-ION**

12 V  
CHARGING TIME  
1h

2000 mAh  
230 min<sup>-1</sup>  
3/8" inch

40 Nm  
0.650 kg



ACCESSORIES 8 pcs:  
Adapter 3/8"-1/4" M, sockets - 10mm, 11mm, 12mm, 13mm, 14mm, 15mm, 17mm.

**NEW PRODUCT**

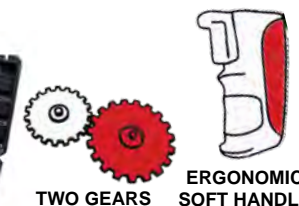

Art.No	gross weight	in cartoon	barcode
030150	0.830 kg	8 pcs	3800972008717

## RECIPROCATING SAW RD-RS31

[BG] Трион саблвиден акумулаторен • [RO] Fierastrau sabie cu acumulator • [SR] ЈКипна Testera • [MK] Батериска Враќање пила • [RU] Акумуляторная сабельная пила • [SL] Vretena žagai • [EL] Πολιτρόφικό πριόνι • [HR] Povratna pila • [FR] Scie alternative • [IT] Sega a batteria con accessori • [ES] Reciproca seruro • [PT] Serra de vaivém

12 V **LITHIUM-ION**

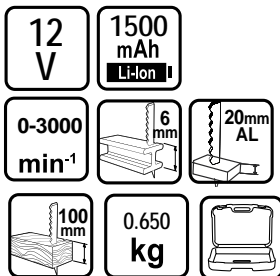

**NEW PRODUCT**



FOR WOOD



FOR METAL

Art.No	barcode
050130	3800972015272

### FOR MODELS:

- RD-CDL09T
- RD-CDL26
- RD-CDL27
- RD-RW01



### BATTERY LI-ION

art. №	V	Ah	barcode
131154	12	1,5	3800972008755
131155	12	2	3800972009899



### CHARGER

art. №	V	barcode
039705	230	3800972008748

## RD-CDL15

12 V **LITHIUM-ION**

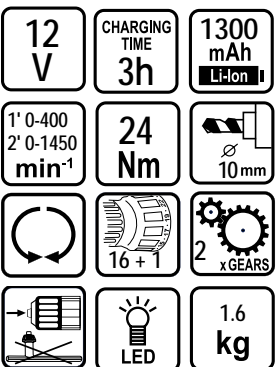

**NEW PRODUCT**



ACCESSORIES 13pcs:  
• 6pcs 25mm screwdriver (PH1, PH2, PZ1, PZ2, 5, 6)  
• 6pcs drill (1, 5, 2, 5, 3, 4, 5, 6)  
• 1pc 60mm bits holder



Art.No	gross weight	in cartoon	barcode
030203	1.800	5	3800123173981

### BATTERY LI-ION

Art.No	gross weight	in cartoon	barcode
131142	0.260	5	3800123173988

### CHARGER FOR CORDLESS DRILL LI-ION

Art.No	in cartoon	barcode
030203	5	3800123173981

## SET CORDLESS DRILL AND HEX IMPACT DRIVER RD-CDIDLO1

[BG] Комплект акумулаторни бормашина и ударен винтоверт • [RO] Kit de foraj fără fir și șurubelniță cu impact • [SR] Akumulatorska bušilica i udarni odvijać • [MK] Комплет за вежбање без кабел и шрафцигер со удари • [RU] Акумуляторный дрель и ударная отвертка • [SL] Akumulatorski komplet vrtalnika in udarni izvijač • [EL] Ακουστικό kit και κατσαβίδι • [HR] Kit bežičnih bušilica i udarni odvijać • [FR] Kit de perceuse sans fil et tournevis à percussion • [IT] Kit trapano avvitatore a batteria e cacciavite a percussione • [ES] Sendrata Krančilo kaj Eфика Šraūbtumilo • [PT] Kit de furadeira sem fio e chave de fenda de impacto



**NEW PRODUCT**  
**LITHIUM-ION**



METAL GEAR BOX

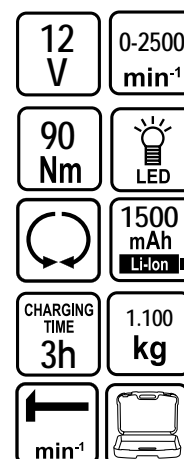

Art.No	gross weight	in cartoon	barcode
030158	1.580	5	3800972016507

### BATTERY LI-ION

Art.No	barcode
131160	3800972019430



### CHARGER LI-ION

Art.No	barcode
032131	3800972019447





**CORDLESS DRILL RDP-CDL28**

[BG] Акумулаторна бормашина • [RO] Bormașină cu acumulator • [SR] Bușilica sa acumulatorom • [MK] Батериска бормашина • [RU] Аккумуляторная дрель • [SL] Akumulatorski vrtalnik vijacnik • [EL] Τρυπάνω Μ Συσσωρευτή • [HR] Akumulatorska bušilica • [FR] Perceuse sans fil avec batterie et chargeur • [IT] Trapano senza cordone con batteria e caricabatterie • [ES] Taladro inalámbrico con batería y cargador • [PT] Aparafusadora

**18 V** **LITHIUM-ION**

**2**  
BATTERIES



TWO GEARS



ERGONOMIC SOFT HANDLE

Art.No	gross weight	in cartoon	barcode
030156	2.3 kg	8 pcs	3800972014534

ACCESSORIES 8 pcs:  
Adapter 3/8"F-1/4"™, sockets - 10mm, 11mm, 12mm, 13mm, 14mm, 15mm, 17mm.

18 V	CHARGING TIME 3h	1500 mAh Li-Ion	1' 0-350 2' 0-1250 min <sup>-1</sup>
38 Nm	10mm	16+1	2 x GEARS
			LED
			2 kg



**BATTERY LI-ION**

art. №	V	Ah	BARCODE
131156	18	1,5	3800972014541



**CHARGER FOR CORDLESS DRILL LI-ION**

art. №	V	barcode
039708	230	3800972014558

**ADAPTER USB 12-18V**

[BG] Адаптор • [RO] Adaptor • [SR] Adapter • [MK] Адаптер • [RU] Адаптер • [SL] Adapter • [EL] Προσαρμογέας • [HR] Adapter • [FR] Adaptateur • [IT] Adattatore • [ES] Adaptiilo • [PT] Adaptador

**12 - 18V** **LITHIUM-ION**

- ✓ USB port provides 5 V 2.1 A to charge phones, tablets, MP3 players and more
- ✓ Built-in battery level gauge
- ✓ USB port cannot be used to charge battery

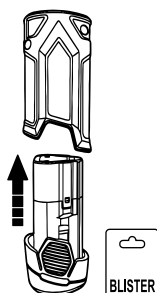

Art.No	gross weight	in cartoon	barcode
032129	0.120 kg	40 pcs	3800972014497

**CORDLESS DRILL RD-CDL25**

[BG] Акумулаторна бормашина • [RO] Bormașină cu acumulator • [SR] Bușilica sa acumulatorom • [MK] Батериска бормашина • [RU] Аккумуляторная дрель • [SL] Akumulatorski vrtalnik vijacnik • [EL] Τρυπάνω Μ Συσσωρευτή • [HR] Akumulatorska bušilica • [FR] Perceuse sans fil avec batterie et chargeur • [IT] Trapano senza cordone con batteria e caricabatterie • [ES] Taladro inalámbrico con batería y cargador • [PT] Aparafusadora

**18 V** **LITHIUM-ION**



TWO GEARS



ERGONOMIC SOFT HANDLE

18 V	CHARGING TIME 3h	1500 mAh Li-Ion	1' 0-350 2' 0-1250 min <sup>-1</sup>
26 Nm	10mm	16+1	2 x GEARS
			LED
			1 kg

ACCESSORIES 12pcs:  
Ø 6 pcs. drills: 1.5 mm; Ø 2.5 mm; Ø 3 mm; Ø 4 mm;  
6 pcs. nozzles: 1 flat nozzle 5 mm;  
1 flat nozzle 6 mm; 1 nozzle Phillips PH1;  
1 nozzle Phillips PH2; 1 nozzle Pozidriv PZ1;  
1 nozzle Pozidriv PZ2;

Art.No	gross weight	in cartoon	barcode
030145	1.8 kg	5 pcs	3800972005051

## CORDLESS DRILL RD-CDL29

[BG] Акумулаторна бормашина • [RO] Bormașină cu acumulator • [SR] Bušilica sa akumulatorom • [MK] Батериска бормашина • [RU] Аккумуляторная дрель • [SL] Akumulatorski vrtalnik vijacnik • [EL] Τρυπάνω Μ Συσσωρευτή • [HR] Akumulatorska bušilica • [FR] Perceuse sans fil avec batterie et chargeur • [IT] Trapano senza cordone con batteria e caricabatterie • [ES] Taladro inalámbrico con batería y cargador • [PT] Aparafusadora

18 V

LITHIUM-ION

2  
BATTERIES

18  
V

CHARGING  
TIME  
1h

0.8-10mm

18 + 1

2x GEARS

1' 0-400  
2' 0-1400  
min<sup>-1</sup>

28 Nm

2x1500  
mAh  
Li-Ion

1.600  
kg

LED

ERGONOMIC  
SOFT HANDLE

NEW  
PRODUCT

TWO GEARS



NEW  
PRODUCT



TWO GEARS



ERGONOMIC  
SOFT HANDLE

Art.No barcode

030157 3800972016484

## CORDLESS IMPACT WRENCH RD-CIW01

[BG] Акумулаторен ударен гайковерт • [RO] Pistol de impact • [SR] Zavrtlač udarni • [MK] Електронски ударен одвртувач • [RU] Импульсный гайковерт • [SL] Udarni avto vijačnik • [EL] Κρουστικό κλειδί αυτοκινήτου • [HR] Udarni odvijač • [FR] Clé à chocs • [IT] Chiave di impatto • [ES] Llave de impacto electrica • [PT] Aparafusadora de impacto

18 V

LITHIUM-ION

18  
V

CHARGING  
TIME  
3h

0-2750  
min<sup>-1</sup>

1/2" inch

3250  
min<sup>-1</sup>

1500  
mAh  
Li-Ion

350  
Nm

ERGONOMIC  
SOFT HANDLE

METAL  
GEAR BOX

LED

1.100  
kg

NEW  
PRODUCT



METAL  
GEAR BOX



ERGONOMIC  
SOFT HANDLE

Art.No gross weight in cartoon barcode

030146 1.3 5 3800972005068

## CORDLESS JIG SAW RD-JSLO1

[BG] Проболен трион без батерия и зарядно • [RO] Fierastrău pendular cu acumulator • [SR] Uvodna testera • [MK] Уводна пила • [RU] Маятниковый лобзик • [SL] Nihajna vobodna žaga • [EL] Παλινδρομική σέγα • [HR] Uvodna pila • [FR] Électrique scie sauteuse • [IT] Sega • [ES] Elektra puzla • [PT] Tico-tico

18 V SOLO

LITHIUM-ION

0-2700  
min<sup>-1</sup>

80 mm

5 mm

45°

DUST CAPTURE  
ПРАХО-УЛАВЯНЕ

1.8  
kg

COLOR BOX

QUICK CHANGE SYSTEM



NEW  
PRODUCT



TOOLLESS BLADE  
REPLACEMENT

Art.No barcode

050132 3800972016514



**CORDLESS CIRCULAR SAW RD-CSLO1**

[BG] Циркулярен акумулаторен без батерия и зарядно • [RO] Fierastrau circular • [SR] Ručni cirkular • [MK] Циркулар рачен • [RU] Дисковая пила • [SL] Krožna žaga • [EL] Δίσκς οπρίο • [HR] Ručna kružna pila • [FR] Meuleuse d'angle • [IT] Sega circolare • [ES] Amoladora angular • [PT] Serra circular

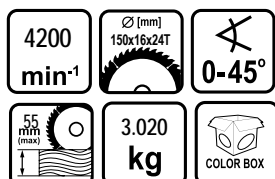
**18 V SOLO** **LITHIUM-ION**
**NEW  
PRODUCT**

**ADJUSTABLE CUTTING DEPTH**

Art.No	gross weight	in cartoon	barcode
052112	3.350 kg	8 pcs	3800972016521

**CORDLESS RECIPROCATING SAW RD-RSLO1**

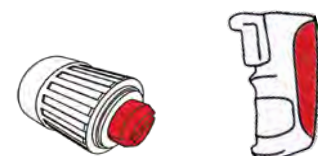
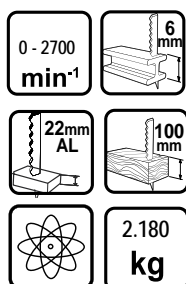
[BG] Трион саблвиден акумулаторен без батерия и зарядно • [RO] Fierastrau sabie cu acumulator • [SR] Sabljasta testera • [MK] Пила сабјарка • [RU] Маятниковый лобзик • [SL] Nihajna vbojna žaga • [EL] Πριόνι σγχα • [HR] Recipro pila • [FR] Scie à mouvement alternative • [IT] Sega universal • [ES] Sierra de sable • [PT] Serra sabre

**18 V SOLO** **LITHIUM-ION**
**NEW  
PRODUCT**

**TOOLLESS BLADE REPLACEMENT**

**ERGONOMIC SOFT HANDLE**

**VARIABLE SPEED**

Art.No	barcode
050133	3800972016538

**BATTERY FOR CORDLESS MACHINES LI-ION**

[BG] Батерия за акумулаторни машини Li-ion • [RO] Acumulator • [SR] Baterija rezervna Li-ion • [MK] Батерија Li-ion • [RU] Аккумулятор Li-ion • [SL] Baterija Li-ion • [EL] Μπαταρία Li-ion για Δραπανοκατασάβιδο • [HR] Li-ion akumulator • [FR] Batterie pour perceuse sans fil Li-ion • [IT] Batteria per batteria Li-ion • [ES] Kuirilaro por Li-ion • [PT] Bateria para Li-ion

**FOR MODELS:**

- RD-GTL22
- RD-HTL04
- RD-CBL04
- RD-CDL25

art. №	V	Ah	BARCODE
131143	18	1,5	3800123174339
131157	18	2	3800972016545
131158	18	4	3800972016552

131143

**LITHIUM-ION  
BATTERY**

131157

**LITHIUM-ION  
BATTERY**

131158

**LITHIUM-ION  
BATTERY**

## SYSTEM STARTER KIT FOR CORDLESS MACHINES LI-ION

[BG] Комплект батерия и зарядно • [RO] Kit de pornire a sistemului pentru mașini fără fir • [SR] Sistemski starter set za bežične mašine • [MK] Систем за стартување систем за безжични машини  
 • [RU] Системный стартовый комплект для беспроводных машин • [SL] Sistemski zaganjalni komplet za brezžične stroje • [EL] Σύστημα εκκίνησης συστήματος για ασύρματα μηχανήματα  
 • [HR] sistemski startni komplet za bežične strojeve • [FR] Kit de démarrage système pour machines sans fil • [IT] Starter kit di sistema per macchine a batteria • [ES] Sistema startigilo por sendrataj mašinoj  
 • [PT] Kit inicial do sistema para máquinas sem fio



LITHIUM-ION  
BATTERY

**NEW  
PRODUCT**



Art.No	V	Ah	barcode
032130	18	2	3800972016569

## CHARGER FOR CORDLESS MACHINES LI-ION

[BG] Зарядно за акумулаторна бормашина Li-ion • [RO] Incarcator acumulator Li-ion • [SR] Punjač baterije Li-ion • [MK] Полнач за батерија [RU] Зарядное устройство для аккумуляторной дрели Li-ion •  
 [SL] Polnilac baterij Li-ion • [EL] Φορτιστής μπαταρίας Li-ion • [HR] Punjač za akumulatorske bušilice Li-ion • [FR] Chargeur pour perceuse rechargeable • [IT] Caricatore per trapano ricaricabile • [ES] Cargilo por reŝargebla drilo • [PT] Carregador para furadeira sem fio

Art.No	for model	V	barcode
032122	RD-GTL22, RD-HTL04, RD-CBL04	230	3800123174346

**18 V**

LITHIUM-ION

**3 - 5 h**



## RAPID CHARGER FOR CORDLESS MACHINES LI-ION

Art.No	for model	V	barcode
032123	RD-GTL22, RD-HTL04, RD-CBL04	230	3800123174377

**18 V**

**1 h**





## GRASS TRIMMER WITH BATTERY AND CHARGER RD-GTL22

[BG] Косачка-тример с батерия и зарядно • [RO] Trimmer pentru iarba cu acumulator • [SR] Trimer za travu sa baterijom i punjačem • [MK] Косилка за трева са батеријом и пуњаčem • [RU] Триммер для травы с аккумулятором и зарядным устройством • [SL] Obrezovalnik trave z baterijo in polnilnikom • [EL] Ηλεκτρικό χορτοκοπτικό • [HR] Kosilica za travu s baterijom i punjačem • [FR] Tondeuse à gazon avec batterie et chargeur • [IT] Taglia erba con batteria e caricabatterie • [ES] Herbo tondilo kun baterio kaj šargilo • [PT] Aparador de grama com bateria e carregador

### 18 V LITHIUM-ION

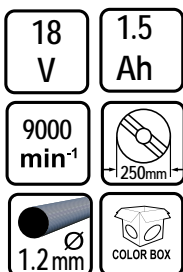

### 18 V SOLO



Art.No	gross weight	in cartoon	barcode
075540	3.730 kg	2 pcs	3800972005143
075528	3.500 kg	2 pcs	3800123174186
without battery and charger			

## CORDLESS HEDGE TRIMMER WITH BATTERY AND CHARGER RD-HTL04

[BG] Резачка за храсти с батерия и зарядно • [RO] Trimmer pt. gard viu cu acumulator • [SR] Bežični trimer za živu ogradu sa baterijom i punjačem • [MK] Бежичен тример со жива хед са батерија и полнач • [RU] Аккумуляторный кусторез с аккумулятором и зарядным устройством • [SL] Akumulatorski škarije za živo mejo z baterijo in polnilnikom • [EL] Ασύρματο φτερό φρένων με μπαταρία και φορτιστή • [HR] Akumulatorski trimer za živu ogradu s baterijom i punjačem • [FR] Taille-haie sans fil avec batterie et chargeur • [IT] Tagliasiepi a batteria con batteria e caricabatterie • [ES] Senkablá heğelezurilo kun baterio kaj šargilo • [PT] Corta-sebes com bateria e carregador

### 18 V LITHIUM-ION

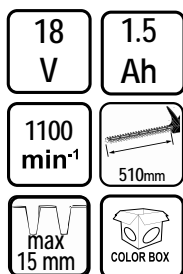

### 18 V SOLO



Art.No	gross weight	in cartoon	barcode
075541	3.550 kg	2 pcs	3800972005150
075704	3.300 kg	2 pcs	3800123174193
without battery and charger			

## CORDLESS BLOWER VACUUM AND SHREDDER WITH BATTERY AND CHARGER RD-CBL04

[BG] Уред за обдување с батерия и зарядно • [RO] Trimmer pt. gard viu cu acumulator • [SR] Usisavač lišća sa baterijom i punjačem • [MK] Всмукувач за лисја са батерија и полнач • [RU] Пылесос для листьев с аккумулятором и зарядным устройством • [SL] Akumulatorski sesalnik za listje • [EL] Μηχανή αναρρόφησης φύλλων • [HR] Akumulatorski usisavač / puhalo lišća • [FR] Aspirateur à feuilles avec batterie et chargeur • [IT] Aspirapolvere a foglia a batteria con batteria e caricabatterie • [ES] Folia polvosučiho kun baterio kaj šargilo • [PT] Soprador com bateria e carregador

### 18 V LITHIUM-ION

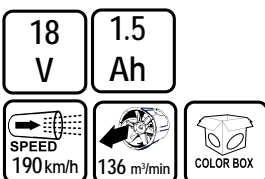

### 18 V SOLO



Art.No	gross weight	in cartoon	barcode
075542	2.800 kg	2 pcs	3800972005167
075530	2.290 kg	2 pcs	3800123174209
without battery and charger			

# ELECTRIC DRILL KEYLESS CHUCK

[BG] Бормашина • [RO] Vormasina r • [SR] Vušilica • [MK] Бормашина • [RU] Дрель • [SL] Vrtnalnik • [EL] Κρουστικό δρέπανο • [HR] Vušilica • [FR] Perceuse • [IT] Trapano • [ES] Taladro • [PT] Aparafusadora

## RDP-ID32

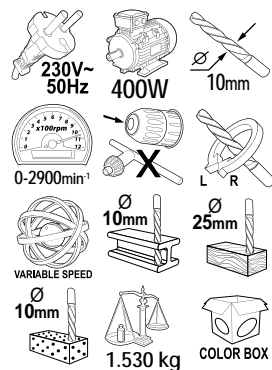

**RAIDER<sup>®</sup>**  
Pro



VARIABLE SPEED

Art.No	gross weight	in cartoon	barcode
010134	1.700 kg	10 pcs	3800123165344

## RDP-ID27

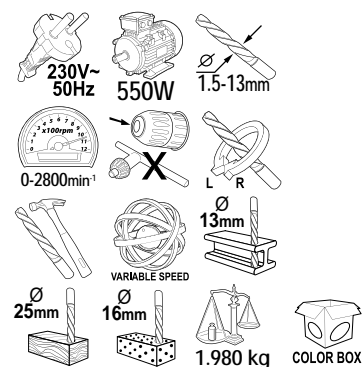

**RAIDER<sup>®</sup>**  
Pro



IMPACT FUNCTION



VARIABLE SPEED

Art.No	gross weight	in cartoon	barcode
010129	2.200 kg	10 pcs	3800123162428

## RDP-ID28

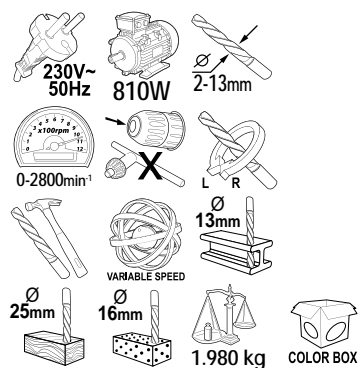

**RAIDER<sup>®</sup>**  
Pro



IMPACT FUNCTION



VARIABLE SPEED

Art.No	gross weight	in cartoon	barcode
010130	2.200 kg	10 pcs	3800123162435



# ELECTRIC IMPACT DRILL KEYLESS CHUCK

[BG] Бормашина • [RO] Bormasina • [SR] Bušilica • [MK] Бормашина • [RU] Дрель • [SL] Vrtalnik • [EL] Κρουστικό βρατάνο • [HR] Bušilica • [FR] Perceuse • [IT] Trapano • [ES] Taladro • [PT] Aparafusadora

**RDP-ID29**

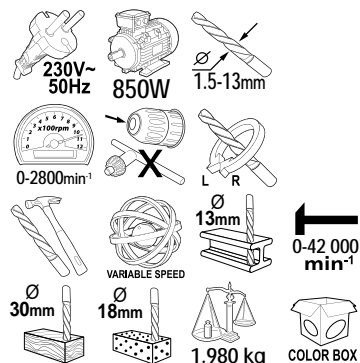

**RAIDER® Pro**

**METAL GEAR BOX**



IMPACT FUNCTION



KEYLESS CHUCK

Art.No	gross weight	in cartoon	barcode
010131	2.200 kg	10 pcs	3800123162442

**RDP-ID31**



**RAIDER® Pro**

**METAL GEAR BOX**



IMPACT FUNCTION



KEYLESS METAL CHUCK

Art.No	gross weight	in cartoon	barcode
010133	3.700 kg	5 pcs	3800123163586

# ELECTRIC IMPACT DRILL KEYLESS CHUCK

**RD-ID40**

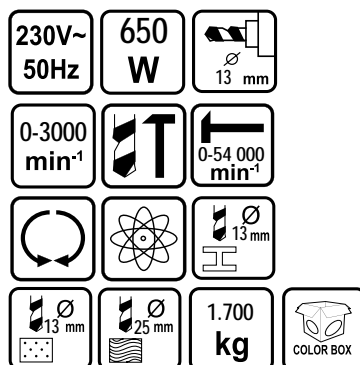

IMPACT FUNCTION



KEYLESS CHUCK

Art.No	gross weight	in cartoon	barcode
010140	1.9 kg	10	3800972005471

# ELECTRIC IMPACT DRILL

[BG] Бормашина • [RO] Bormasina • [SR] Bušilica • [MK] Бормашина • [RU] Дрель • [SL] Vrtnik • [EL] Κρουστικό δρέπανο • [HR] Bušilica • [FR] Perceuse • [IT] Trapano • [ES] Taladro • [PT] Aparafusadora

## RD-ID41

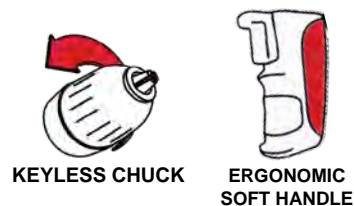
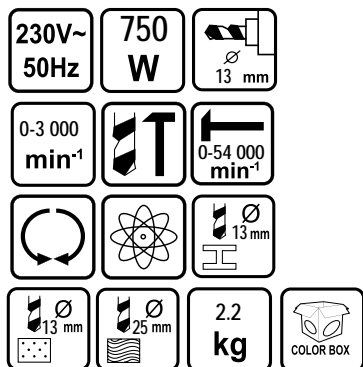

Art.No	gross weight	in cartoon	barcode
010141	2.4 kg	10	3800972008694

## RD-ID36

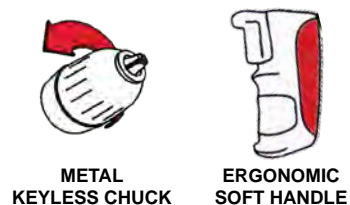
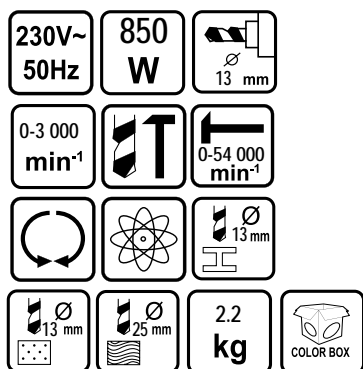

Art.No	gross weight	in cartoon	barcode
010139	2.4 kg	10	3800972001183

## RD-ID22

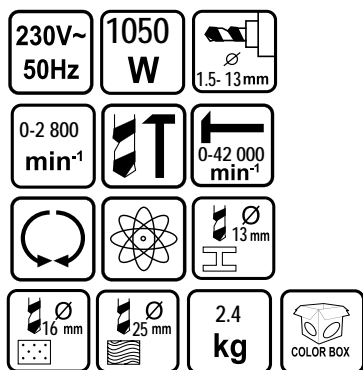

Art.No	gross weight	in cartoon	barcode
010119	2.7 kg	10	3800123154676

## RD-ID44

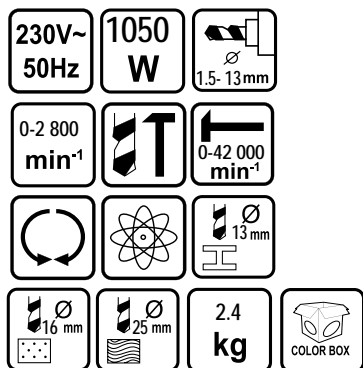

**NEW PRODUCT**

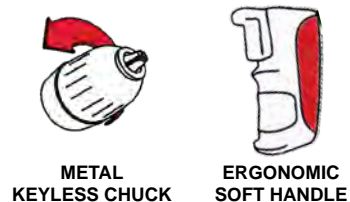

Art.No	gross weight	in cartoon	barcode
010142	2.7 kg	10	3800972018891

ACCESSORIES PNEUMATICS RAIDER MACHINES R20 SYSTEM



# BENCH DRILL

[BG] Настолна бормашина • [RO] Masina de gaurit fixa • [SR] Bušilica stubna • [MK] Бормашина • [RU] Настольно-сверлильный станок [SL] Namizni vrtalni stroj • [EL] Κρουστικό Δράπανο • [HR] Stupna bušilica • [FR] Perceuse d'établi • [IT] Trapano da banco • [ES] Benka trilo • [PT] Berbequim vertical

## RDP-BD04

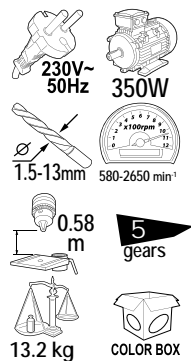

### SPINDLE SPEED

580 min<sup>-1</sup>  
850 min<sup>-1</sup>  
1220 min<sup>-1</sup>  
1650 min<sup>-1</sup>  
2650 min<sup>-1</sup>

**RAIDER®**  
*Pro*



VARIABLE SPEED

Art.No	gross weight	in carton	barcode
011104	14 kg	1	3800123108693

## RDP-BD05

**NEW  
PRODUCT**

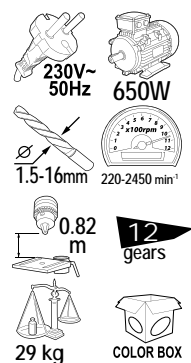

### SPINDLE SPEED

220 min<sup>-1</sup>  
330 min<sup>-1</sup>  
350 min<sup>-1</sup>  
450 min<sup>-1</sup>  
520 min<sup>-1</sup>  
560 min<sup>-1</sup>  
1050 min<sup>-1</sup>  
1130 min<sup>-1</sup>  
1300 min<sup>-1</sup>  
1630 min<sup>-1</sup>  
1800 min<sup>-1</sup>  
2450 min<sup>-1</sup>

**RAIDER®**  
*Pro*



VARIABLE SPEED

Art.No	gross weight	in carton	barcode
011105	31 kg	1	3800972018457

## RDP-BD02

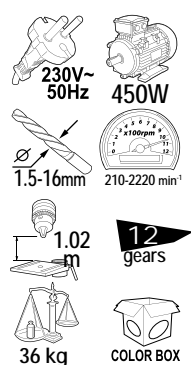

### SPINDLE SPEED

210 min<sup>-1</sup>  
300 min<sup>-1</sup>  
350 min<sup>-1</sup>  
450 min<sup>-1</sup>  
500 min<sup>-1</sup>  
540 min<sup>-1</sup>  
970 min<sup>-1</sup>  
1040 min<sup>-1</sup>  
1170 min<sup>-1</sup>  
1480 min<sup>-1</sup>  
1580 min<sup>-1</sup>  
2220 min<sup>-1</sup>

**RAIDER®**  
*Pro*



VARIABLE SPEED

Art.No	gross weight	in carton	barcode
011102	38 kg	1	3800123123122

## RDP-BD03

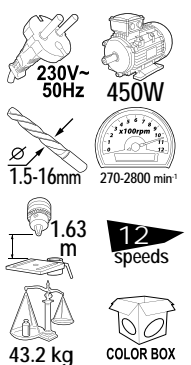

### SPINDLE SPEED

270 min<sup>-1</sup>  
360 min<sup>-1</sup>  
490 min<sup>-1</sup>  
560 min<sup>-1</sup>  
590 min<sup>-1</sup>  
970 min<sup>-1</sup>  
1100 min<sup>-1</sup>  
1250 min<sup>-1</sup>  
1350 min<sup>-1</sup>  
1620 min<sup>-1</sup>  
2120 min<sup>-1</sup>  
2800 min<sup>-1</sup>

**RAIDER®**  
*Pro*



VARIABLE SPEED

Art.No	gross weight	in carton	barcode
011103	48 kg	1	3800123124860

# DRYWALL SCREWDRIVER

[BG] Винтоверт • [RO] Surubelnita electrica • [SR] Električni Odvijajač • [MK] Штрафилица • [RU] Электрическая отвёртка • [SL] Izvijač zavijake zagips plošče • [EL] Ηλεκτρικό καταβίδι για γυψοσανίδες • [HR] Odvijajač • [FR] Tournevis à cloisons sèches • [IT] Cacciavite per cartongesso • [ES] Desegnilo drywall • [PT] Aparafusadora p/ gesso cartonado

## RD-CDD07

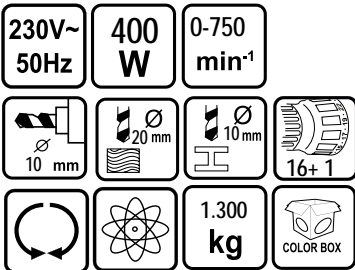

**NEW  
PRODUCT**



ERGONOMIC  
SOFT HANDLE

Art.No	barcode
073108	3800972016446

## RD-CDD08

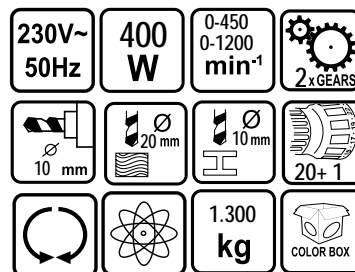

**NEW  
PRODUCT**



TWO GEARS



ERGONOMIC  
SOFT HANDLE

Art.No	barcode
073109	3800972016453

## RD-CDD04

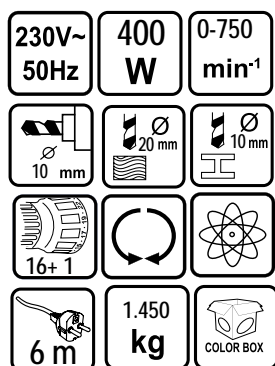

ERGONOMIC ON/OFF  
SWITCH

Art.No	gross weight	in cartoon	barcode
073105	1.650 kg	10 pcs	3800972004221

## RD-CDD03

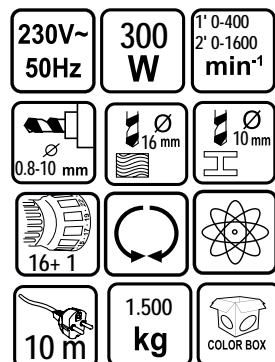

TWO GEARS



ERGONOMIC  
SOFT HANDLE

Art.No	gross weight	in cartoon	barcode
073104	1.700 kg	5 pcs	3800123167539



# DRAYWALL SCREWDRIVER

[BG] Винтоверт • [RO] Surubelnita electrica • [SR] Električni Odvijač • [MK] Штрафилица • [RU] Электрическая отвёртка • [SL] Izvijač zavijake zagips plošče • [EL] Ηλεκτρικό κατσαβίδι για γυψοσανίδες • [HR] Odvijač • [FR] Tournevis à cloisons sèches • [IT] Cacciavite per cartongesso • [ES] Desegnilo drywall • [PT] Aparafusadora p/ gesso cartonado

## RDP-CDD06

**NEW PRODUCT**



**RAIDER® Pro**



Art.No	barcode
073301	3800972016439

## RDP-CDD02



**RAIDER® Pro**



Art.No	gross weight	in cartoon	barcode
073103	3 kg	5 pcs	3800123166075

# DRAYWALL SCREWDRIVER

[BG] Винтоверт • [RO] Surubelnita electrica • [SR] Električni Odvijač • [MK] Штрафилица • [RU] Электрическая отвёртка • [SL] Izvijač zavijake zagips plošče • [EL] Ηλεκτρικό κατσαβίδι για γυψοσανίδες • [HR] Odvijač • [FR] Tournevis à cloisons sèches • [IT] Cacciavite per cartongesso • [ES] Desegnilo drywall • [PT] Aparafusadora p/ gesso cartonado

## RD-ES46

230V~50Hz	520 W	
0-4500 min⁻¹	10 Nm	1.7 kg
1/4"		COLOR BOX



Art.No	gross weight	in cartoon	barcode
073101	1.900 kg	5 pcs	3800123163616

## RD-ES47

230V~50Hz	710 W	
0-4000 min⁻¹	10 Nm	1.8 kg
1/4"		COLOR BOX



**METAL GEAR BOX**



VARIABLE SPEED

Art.No	gross weight	in cartoon	barcode
073107	2.000 kg	10 pcs	3800972010642







# IMPACT WRENCH

[BG] Гайковерт ударен • [RO] Pistol de impact • [SR] Zavrtać udarni • [MK] Електронски ударен одвртувач • [RU] Импульсный гайковерт • [SL] Udarni avto vijajnik • [EL] Κρουστικό κλειδί αυτοκίνητου • [HR] Udarni odvijač • [FR] Clé à chocs • [IT] Chiave di impatto • [ES] Llave de impacto • [PT] Chave de impacto

## RD-EIW07

230V~  
50Hz

450  
W

0-3000  
min<sup>-1</sup>

350  
Nm

1/2" inch



2.9  
kg



**NEW  
PRODUCT**

ACCESSORIES 4pcs:  
Sockets 17,19,21,22 mm



**METAL  
GEAR BOX**

Art.No	gross weight	in cartoon	barcode
073206	3.120 kg	5 pcs	3800972016385

## RD-EIW06

230V~  
50Hz

950  
W

2300  
min<sup>-1</sup>

450  
Nm

1/2" inch



5.400  
kg



ACCESSORIES 4pcs:  
Sockets 17,19,21,22 mm



**METAL  
GEAR BOX**

Art.No	gross weight	in cartoon	barcode
073205	6 kg	2 pcs	3800972010444

## RD-EIW04

230V~  
50Hz

1100  
W

2200  
min<sup>-1</sup>

450  
Nm

1/2" inch



4.3  
kg



**ERGONOMIC ON/OFF  
SWITCH**

Art.No	gross weight	in cartoon	barcode
073203	4.800 kg	5 pcs	3800972002555

## RD-EIW05

230V~  
50Hz

1050  
W

2200  
min<sup>-1</sup>

500  
Nm

1/2" inch



5.3  
kg



**LCD DISPLAY**



**METAL  
GEAR BOX**



**ERGONOMIC ON/OFF  
SWITCH**

Art.No	gross weight	in cartoon	barcode
073204	5.900 kg	4 pcs	3800972002562

# ROTARY HAMMER

[BG] Перфоратор • [RO] Ciocan rotorecutor • [SR] Čekić bušilica • [MK] Ударен чекан • [RU] Перфоратор • [SL] Rotacijski udarni vrtnalnik • [EL] Περιστροφικό δραπάνο με σφυρί • [HR] Čekić udarni • [FR] Marteau rotatif • [IT] Martello rotante • [ES] Rotaj hammer • [PT] Martelo perfurador

## RD-HD53

230V~ 50Hz	620 W	0-1000 min <sup>-1</sup>
4850 min <sup>-1</sup>	2.0 J	
	SDS+	
	2.600 kg	

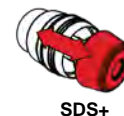

SDS+

Art.No	gross weight	in cartoon	barcode
013135	3.330 kg	5 pcs	3800972009189

## RD-HD54

230V~ 50Hz	750 W	0-1000 min <sup>-1</sup>
4850 min <sup>-1</sup>	2.2 J	
	SDS+	
	2.800 kg	



FOUR FUNCTION

Art.No	gross weight	in cartoon	barcode
013136	4.070 kg	5 pcs	3800972009196

## RD-HD40

230V~ 50Hz	800 W	0-1000 min <sup>-1</sup>
4850 min <sup>-1</sup>	2.2 J	
	SDS+	
	4.8 kg	

ACCESSORIES:  
3 drill bits (Ø6 / 8 / 10 x 150mm)  
1pc flat chisel (14 x 250mm)  
1pc point chisel (14 x 250mm)  
1pc depth ruler



FOUR FUNCTION

Art.No	gross weight	in cartoon	barcode
012104	5.300 kg	2 pcs	3800123173431

## RD-HD38

230V~ 50Hz	800 W	0-930 min <sup>-1</sup>
5000 min <sup>-1</sup>	2.5 J	
	SDS+	
	5.1 kg	

ACCESSORIES:  
3 drill bits (Ø8/10/12 x 150mm)  
1pc flat chisel  
1pc point chisel (Ø14 x 250mm)  
1bottle grease  
1pc dust cover  
1pc depth ruler



FOUR FUNCTION

Art.No	gross weight	in cartoon	barcode
013126	5.660 kg	2 pcs	3800123167003



# ROTARY HAMMER

[BG] Перфоратор • [RO] Ciocan rotorpercutor • [SR] Čekić bušilica • [MK] Ударен чекан • [RU] Перфоратор • [SL] Rotacijski udarni vrtalnik • [EL] Περιστροφικό δραπάνο με σφυρί • [HR] Čekić udarni • [FR] Marteau rotatif • [IT] Martello rotante • [ES] Rotaj hammer • [PT] Martelo perfurador

## RD-HD51

230V~ 50Hz	1050 W	0-900 min <sup>-1</sup>
5000 min <sup>-1</sup>	3.4 J	
	SDS+	

3.300 kg



Art.No	gross weight	in carton	barcode
012105	3.800 kg	2 pcs	3800972008434

## RDP-HD05S

230V~ 50Hz	750W	0-980 min <sup>-1</sup>
0-4850 min <sup>-1</sup>	2.6J	
	VARIABLE SPEED	

3 kg



Art.No	gross weight	in carton	barcode
012101	4 kg	3 pcs	3800123124785

## RDP-HD12H

230V~ 50Hz	950W	0-1200 min <sup>-1</sup>
0-4820 min <sup>-1</sup>	3J	
	VARIABLE SPEED	

3.2 kg



**RAIDER®**  
Pro



Art.No	gross weight	in carton	barcode
012103	4.200 kg	3 pcs	3800123153884

## RD-HD52

230V~ 50Hz	1010 W	0-800 min <sup>-1</sup>
4000 min <sup>-1</sup>	3.5 J	
	SDS+	

6 kg

ACCESSORIES:  
3 drill bits (Ø8/10/12 x 150mm)  
1pc flat chisel  
1pc point chisel (Ø14 x 250mm)  
1bottle grease  
1pc dust cover  
1pc depth ruler

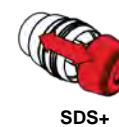

Art.No	gross weight	in carton	barcode
013134	6.330 kg	3 pcs	3800972008915

# ROTARY HAMMER

[BG] Перфоратор • [RO] Ciocan rotopercurator • [SR] Čekić bušilica • [MK] Ударен чекан • [RU] Перфоратор • [SL] Rotacijski udarni vrtalnik • [EL] Περιστροφικό δρασπανο με σφυρί • [HR] Čekić udarni • [FR] Marteau rotatif • [IT] Martello rotante • [ES] Rotaj hammer • [PT] Martelo perfurador

## RD-HD04

230V~ 50Hz	850 W	0-800 min <sup>-1</sup>
2900 min <sup>-1</sup>	3.5 J	
SDS+		7.900 kg

ACCESSORIES:  
 SDS+ 08x150 mm drill bit  
 SDS+ 10x150 mm drill bit  
 SDS+ 12x150 mm drill bit  
 SDS+ 14x250 mm flat chisel  
 SDS+ 14x250 mm pointed chisel



SDS+



ANTIVIBRATION  
HANDLE

Art.No	gross weight	in cartoon	barcode
013111	8.200 kg	2 pcs	3800123160837

## RD-HD37

230V~ 50Hz	1250 W	730 min <sup>-1</sup>
4000 min <sup>-1</sup>	3.5 J	
SDS+		7.4 kg

ACCESSORIES:  
 • 3 drill bits (Ø8/10/12 x 150mm)  
 • 1pc flat chisel  
 • 1pc point chisel (Ø14 x 250mm)  
 • 1pc grease  
 • 1pc dust cover  
 • 1pc depth ruler



SDS+



ANTIVIBRATION  
HANDLE

Art.No	gross weight	in cartoon	barcode
013125	8.200 kg	2 pcs	3800123167027

## RD-HD46

230V~ 50Hz	1500 W	0-850 min <sup>-1</sup>
0-4700 min <sup>-1</sup>	4.3 J	
SDS+		7.4 kg

ACCESSORIES:  
 SDS+ 6x150 mm drill bit  
 SDS+ 8x150 mm drill bit  
 SDS+ 10x150 mm drill bit  
 SDS+ 14x250 mm flat chisel  
 SDS+ 14x250 mm pointed chisel



SDS+



ANTIVIBRATION  
HANDLE



FOUR FUNCTION

Art.No	gross weight	in cartoon	barcode
013132	8.260 kg	2 pcs	3800123174841

## RD-HD47

230V~ 50Hz	1600 W	0-850 min <sup>-1</sup>
0-4700 min <sup>-1</sup>	4.3 J	
SDS+		7.4 kg

ACCESSORIES:  
 • 3 drill bits (Ø6 / 8 / 10 x 150mm)  
 • 1pc flat chisel (Ø14 x 250mm)  
 • 1pc point chisel (Ø14 x 250mm)



SDS+



ANTIVIBRATION  
HANDLE



FOUR FUNCTION

Art.No	gross weight	in cartoon	barcode
013133	8.250 kg	2 pcs	3800972001503



# ROTARY HAMMER

[BG] Перфоратор • [RO] Ciocan rotopercutor • [SR] Čekić bušilica • [MK] Ударен чекан • [RU] Перфоратор • [SL] Rotacijski udarni vrtalnik • [EL] Περιστροφικό δρασπανο με σφυρι • [HR] Čekić udarni • [FR] Marteau rotatif • [IT] Martello rotante • [ES] Rotaj hammer • [PT] Martelo perfurador

## RDP-HD35

230V~50Hz 1500W 100-800 min<sup>-1</sup>  
 4.5J Ø70 mm  
 650-2700 min<sup>-1</sup>  
 40mm 36mm 13mm SDS+  
 3 functions VARIABLE SPEED 7.65 kg

3 drill bits (Ø8/10/12 x 150mm)  
 1pc flat chisel  
 1pc point chisel (Ø14 x 250mm)  
 1bottle grease  
 1pc dust cover  
 1pc depth ruler



**RAIDER®**  
Pro

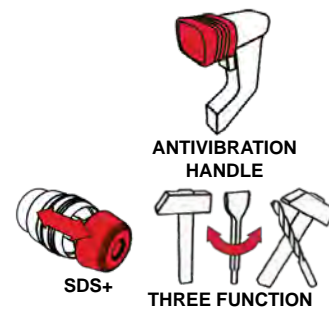

Art.No	gross weight	in carton	barcode
013123	8.500 kg	2 pcs	3800123165603

## RDP-HD57

230V~50Hz 1600W 0-800 min<sup>-1</sup>  
 6J  
 0-4000 min<sup>-1</sup>  
 40mm 32mm 13mm SDS+  
 4 functions VARIABLE SPEED 8.5 kg

3 drill bits (Ø8/10/12 x 150mm)  
 1pc flat chisel  
 1pc point chisel (Ø14 x 250mm)  
 1bottle grease  
 1pc dust cover  
 1pc depth ruler



**RAIDER®**  
Pro

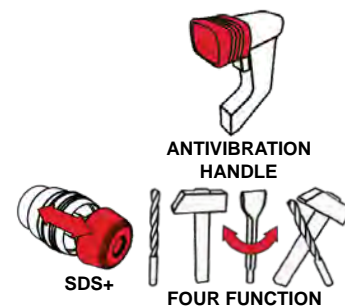

Art.No	gross weight	in carton	barcode
012203	9.00 kg	2 pcs	3800972016460

## RDP-HD56

230V~50Hz 1800W 140-1050 min<sup>-1</sup>  
 6J  
 740-5570 min<sup>-1</sup>  
 40mm 35mm 13mm SDS+  
 3 functions VARIABLE SPEED 5.920 kg

**NEW PRODUCT**

3 drill bits (Ø8/10/12 x 150mm)  
 1pc flat chisel  
 1pc point chisel (Ø14 x 250mm)  
 1bottle grease  
 1pc dust cover  
 1pc depth ruler



**RAIDER®**  
Pro

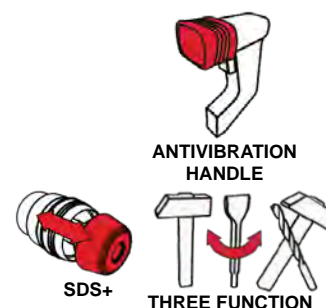

Art.No	barcode
012202	3800972016187

## RDP-HD39

230V~50Hz 720W 300-800 min<sup>-1</sup>  
 3.8J  
 2650 min<sup>-1</sup>  
 30mm 24mm 13mm SDS+  
 3 functions VARIABLE SPEED 6.5 kg

ACCESSORIES:  
 3 pcs SDS+ drill bits  
 SDS+ 14x250 mm flat chisel  
 SDS+ 250 mm point chisel



**RAIDER®**  
Pro

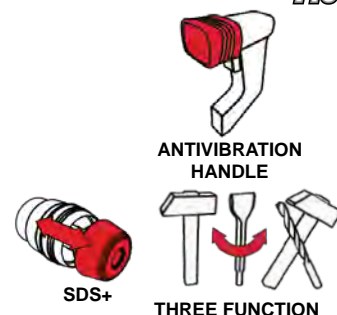

Art.No	gross weight	in carton	barcode
013127	7.260 kg	2 pcs	3800123167522

# ROTARY HAMMER

[BG] Перфоратор • [RO] Ciocan rotopercurator • [SR] Čekić bušilica • [MK] Ударен чекан • [RU] Перфоратор • [SL] Rotacijski udarni vrtnik • [EL] Περιστροφικό δραπάνο με σφυρί • [HR] Čekić udarni • [FR] Marteau rotatif • [IT] Martello rotante • [ES] Rotaj hammer • [PT] Martelo perfurador

## RDP-HD31

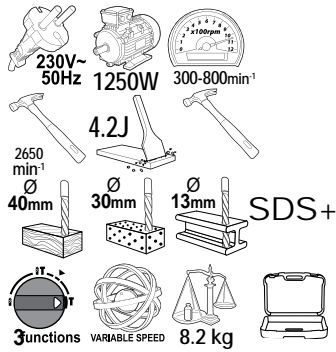

ACCESSORIES:  
3 pcs SDS+ drill bits  
SDS+ 14x250 mm flat chisel  
SDS+ 250 mm point chisel

**RAIDER<sup>®</sup>**  
Pro

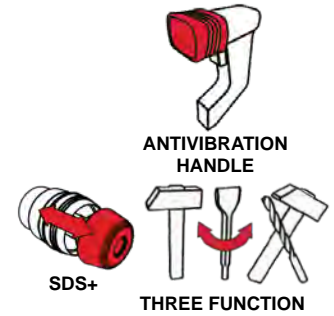

ANTIVIBRATION  
HANDLE

SDS+

THREE FUNCTION

Art.No	gross weight	in carton	barcode
013112	9.100 kg	2 pcs	3800123160844

## RDP-HD30

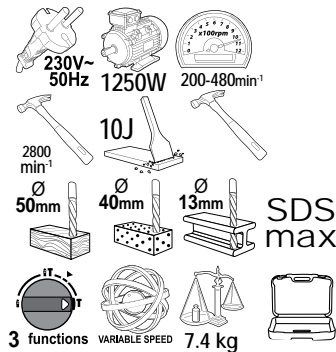

ACCESSORIES:  
3 pcs SDS max drill bits  
SDS max 14x250 mm flat chisel  
SDS max 14x250 mm pointed chisel

**RAIDER<sup>®</sup>**  
Pro

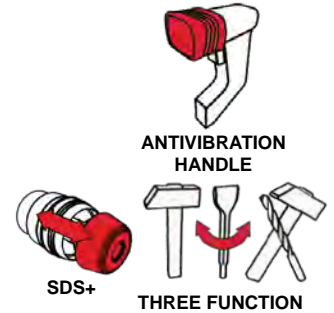

ANTIVIBRATION  
HANDLE

SDS+

THREE FUNCTION

Art.No	gross weight	in carton	barcode
013201	8.4	2 pcs	3800123158575

## RDP-HD55

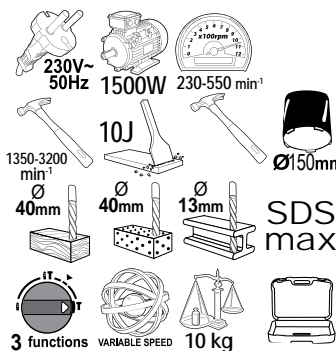

ACCESSORIES:  
3 pcs SDS max drill bits  
SDS max 14x250 mm flat chisel  
SDS max 14x250 mm pointed chisel

**RAIDER<sup>®</sup>**  
Pro

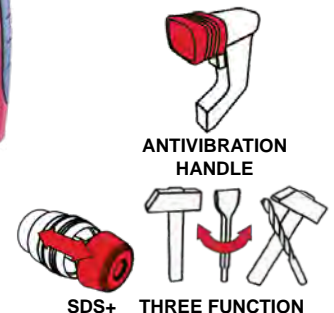

ANTIVIBRATION  
HANDLE

SDS+

THREE FUNCTION

Art.No	gross weight	in carton	barcode
013202	11.250 kg	2 pcs	3800972009622

ACCESSORIES PNEUMATICS RAIDER MACHINES R20 SYSTEM



# DEMOLITION HAMMER

[BG] Кърпач • [RO] Ciocan rotorpercutor • [SR] Čekić bušilica • [MK] Ударен чекан • [RU] Перфоратор • [SL] Rotacijski udarni vrtnalnik • [EL] Περιστροφικό δραστικό με σφυρί • [HR] Čekić udarni • [FR] Marteau rotatif • [IT] Martello rotante • [ES] Rotaj hammer • [PT] Martelo perfurador

**RDP-DH03**

**NEW  
PRODUCT**

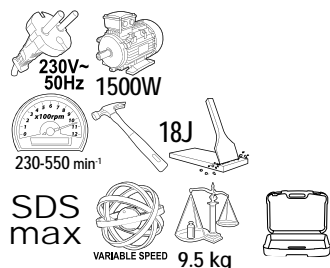

**RAIDER®  
Pro**

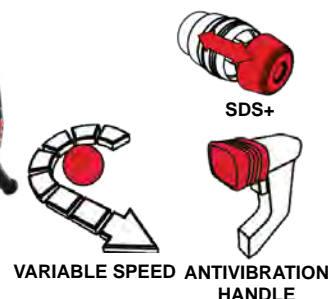

Art.No	gross weight	in carton	barcode
012204	10.00 kg	2 pcs	3800972016477

**RD-DH02**

**NEW  
PRODUCT**

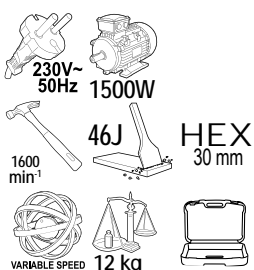

**METAL CASE**



Art.No	barcode
013137	3800972016347



# ANGLE GRINDER

[BG] Ъглошлайф • [RO] Polizor unghiular • [SR] Brusilica ugaona • [MK] Брусилка • [RU] Угловая шлифовальная машина • [SL] Kotni brusilnik • [EL] ΓΩΝΙΑΚΟΣ ΤΡΟΧΟΣ • [HR] Kutna brusilica • [FR] Meuleuse à angle • [IT] Smerigliatrice angolare • [ES] Angulo muellelo • [PT] Rebarbadora

## RD-AG49

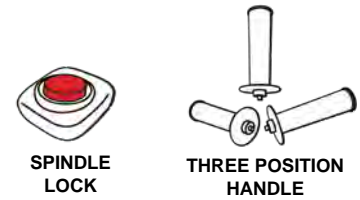
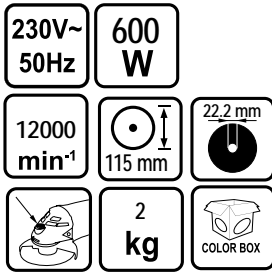

Art.No	gross weight	in carton	barcode
020147	2.170 kg	6 pcs	3800123166822

## RD-AG66

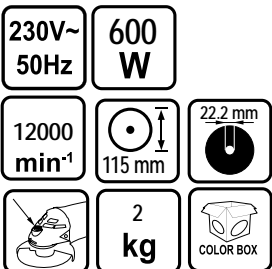

**NEW PRODUCT**



Art.No	gross weight	in carton	barcode
020154	2.170 kg	6 pcs	3800972018860

## RD-AG25

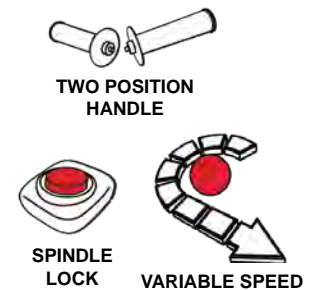
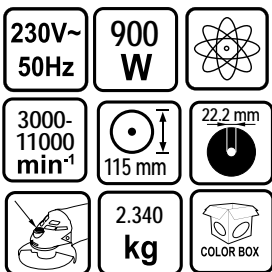

Art.No	gross weight	in carton	barcode
020123	2.600 kg	6 pcs	3800123154928

## RD-AG34

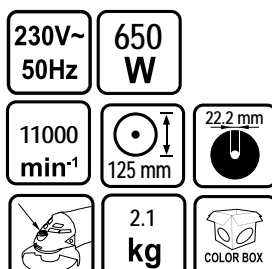

Art.No	gross weight	in carton	barcode
020136	2.340 kg	6 pcs	3800123162466



**RD-AG60**



230V~ 50Hz	750 W
12000 min <sup>-1</sup>	125 mm
	2.5 kg
	22.2 mm
	COLOR BOX



SPINDLE LOCK



TWO POSITION HANDLE

Art.No	gross weight	in carton	barcode
020153	2.700 kg	6 pcs	3800972009868

**RD-AG51**



230V~ 50Hz	750 W
12000 min <sup>-1</sup>	125 mm
	2.9 kg
	22.2 mm
	COLOR BOX



SPINDLE LOCK

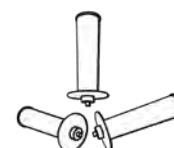

THREE POSITION HANDLE

Art.No	gross weight	in carton	barcode
020149	3.100 kg	4 pcs	3800972000780

**RD-AG36**



230V~ 50Hz	850 W
11000 min <sup>-1</sup>	125 mm
	2.3 kg
	22.2 mm
	COLOR BOX



SPINDLE LOCK



TWO POSITION HANDLE

Art.No	gross weight	in carton	barcode
020138	2.600 kg	6 pcs	3800123162480

**RD-AG44T**



230V~ 50Hz	900 W
12000 min <sup>-1</sup>	125 mm
	2.300 kg
	22.2 mm
	COLOR BOX



SPINDLE LOCK



TWO POSITION HANDLE

Art.No	gross weight	in carton	barcode
020145	2.600 kg	6 pcs	3800123167355

## RD-AG37

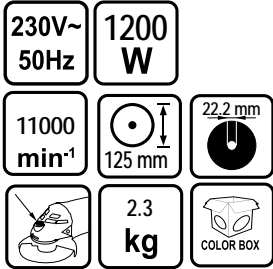

SPINDLE  
LOCK

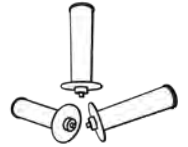

THREE POSITION  
HANDLE

Art.No	gross weight	in cartoon	barcode
020139	2.500 kg	6 pcs	3800123162497

## RD-AG39

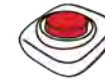
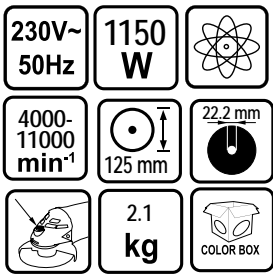

SPINDLE  
LOCK

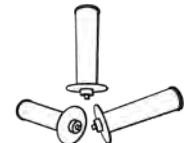

THREE POSITION  
HANDLE

Art.No	gross weight	in cartoon	barcode
020140	2.300 kg	6 pcs	3800123162534

## RD-AG54

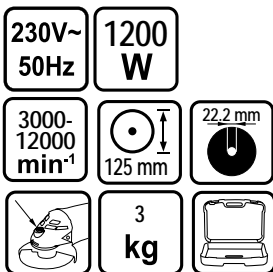

SPINDLE  
LOCK

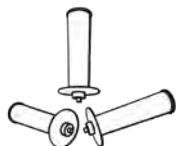

THREE POSITION  
HANDLE

Art.No	gross weight	in cartoon	barcode
020152	4.0 kg	4 pcs	3800972000810

## RDP-AG21Z

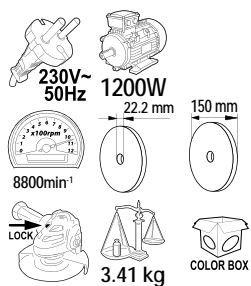

SPINDLE  
LOCK

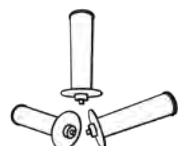



THREE POSITION  
HANDLE

Art.No	gross weight	in cartoon	barcode
020118	3.790 kg	4 pcs	3800123122552

**RAIDER<sup>®</sup>**  
*Pro*



**RD-AG10T**

230V~ 50Hz	1400 W	4000- 8000 min <sup>-1</sup>
SOFT START	180 mm	22,2 mm
	3.900 kg	 COLOR BOX

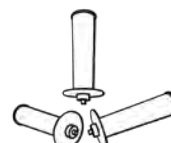

THREE POSITION  
HANDLE





SPINDLE  
LOCK



SOFT START

Art.No	gross weight	in cartoon	barcode
020107	4.060 kg	2 pcs	3800123124617

**RD-AG38**

230V~ 50Hz	2350 W	6000 min <sup>-1</sup>
SOFT START	230 mm	22,2 mm
	5.200 kg	 COLOR BOX

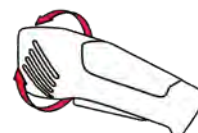

ROTATING HANDLE



SPINDLE  
LOCK



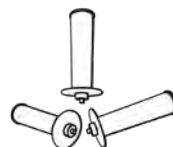

SOFT START



THREE POSITION  
HANDLE

Art.No	gross weight	in cartoon	barcode
020201	5.760 kg	2 pcs	3800123162503

**RD-AG55**

230V~ 50Hz	2350 W	6500 min <sup>-1</sup>
SOFT START	230 mm	22,2 mm
	5.1 kg	



SPINDLE  
LOCK



SOFT START

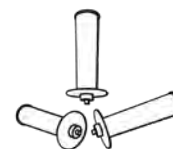

THREE POSITION  
HANDLE

Art.No	gross weight	in cartoon	barcode
020203	5.700 kg	2 pcs	3800972000827

**RD-AG45**

230V~ 50Hz	2500 W	11000 min <sup>-1</sup>
SOFT START	230 mm	22,2 mm
	6.3 kg	 COLOR BOX

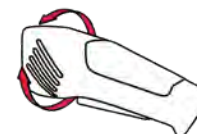

ROTATING HANDLE



SPINDLE  
LOCK



SOFT START

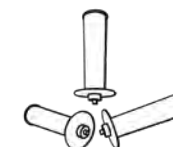

THREE POSITION  
HANDLE

Art.No	gross weight	in cartoon	barcode
020202	6.580 kg	2 pcs	3800123171796

# STRAIGHT GRINDER RDP-DG01

[BG] Прав шлайф • [RO] Polizor unghiular • [SR] Brusilica ugaona • [MK] Брусила • [RU] Прямая шлифовальная машина • [SL] Brusilnik • [EL] ΤΡΟΧΟΣ • [HR] Kutna brusilica • [FR] Meuleuse à angle • [IT] Smerigliatrice angolare • [ES] Angulo muelilo • [PT] Rebarbadora

**RAIDER**  
Pro

**NEW**  
PRODUCT

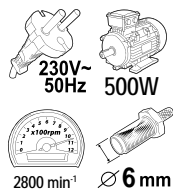





Art.No	barcode
041602	3800972019683



# JIG SAW

[BG] Прободен трион • [RO] Ferstrau pendular • [SR] Ubodna testera • [MK] Убодна пила • [RU] Маятниковый лобзик • [SL] Nihajna vbodna žaga • [EL] Παλινδρομική σέγα • [HR] Ubodna pila • [FR] Électrique scie sauteuse • [IT] Sega • [ES] Elektra puzla • [PT] Tico-tico

## RD-JS31





230V~ 50Hz	500 W	3000 min <sup>-1</sup>
		
DUST CAPTURE ПРАХО-УЛАВЛЯНЕ	2.1 kg	



PENDULUM FUNCTION

Art.No	gross weight	in carton	barcode
050126	2.200 kg	10 pcs	3800972009745

## RD-JS32





230V~ 50Hz	650 W	3000 min <sup>-1</sup>
		
	DUST CAPTURE ПРАХО-УЛАВЛЯНЕ	2.1 kg



PENDULUM FUNCTION

Art.No	gross weight	in carton	barcode
050127	2.200 kg	10 pcs	3800972009864

## RD-JS33

230V~ 50Hz	750 W	0-3000 min <sup>-1</sup>
		
	DUST CAPTURE ПРАХО-УЛАВЛЯНЕ	1.900 kg









PENDULUM FUNCTION



QUICK CHANGE SYSTEM

Art.No	gross weight	in carton	barcode
050128	2.150 kg	10 pcs	3800972009851

## RD-JS28

230V~ 50Hz	850 W	0-3000 min <sup>-1</sup>	
			
	DUST CAPTURE ПРАХО-УЛАВЛЯНЕ	2.1 kg	

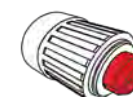

QUICK CHANGE SYSTEM



PENDULUM FUNCTION LASER

Art.No	gross weight	in carton	barcode
050125	2.200 kg	10 pcs	3800972001190

## RDP-JS25

**RAIDER<sup>®</sup>**  
*Pro*

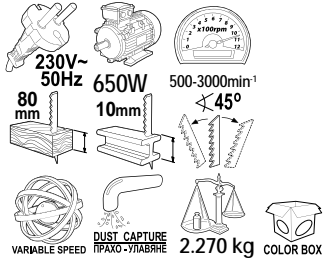

PENDULUM FUNCTION

Art.No	gross weight	in cartoon	barcode
050119	2.520 kg	8 pcs	3800123167232

## RDP-JS34

**NEW  
PRODUCT**

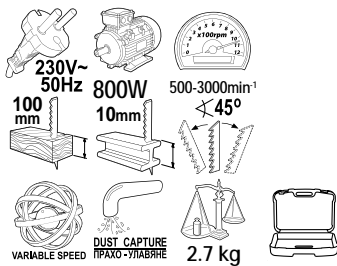

**RAIDER<sup>®</sup>**  
*Pro*

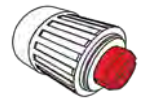

QUICK CHANGE SYSTEM



PENDULUM FUNCTION LASER

Art.No	gross weight	in cartoon	barcode
050203	3.00 kg	5 pcs	3800972016361

## RDP-JS21

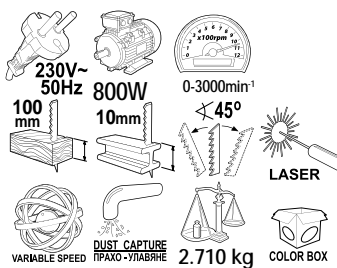

**RAIDER<sup>®</sup>**  
*Pro*

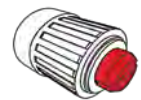

QUICK CHANGE SYSTEM



PENDULUM FUNCTION LASER

Art.No	gross weight	in cartoon	barcode
050201	3.020 kg	10 pcs	3800123159022

## RDP-JS26

**RAIDER<sup>®</sup>**  
*Pro*

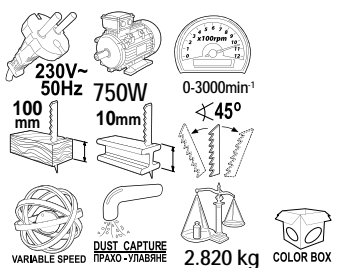

PENDULUM FUNCTION

Art.No	gross weight	in cartoon	barcode
050120	3.140 kg	5 pcs	3800123167249



# RECIPROCATING SAW

[BG] Трион саблевиден • [RO] Fierastrau pendular • [SR] Sabljasta testera • [MK] Пила сабјарка • [RU] Маятниковый лобзик • [SL] Nihajna vbojna žaga • [EL] Πριονι σεγα • [HR] Recipro pila • [FR] Scie à mouvement alternative • [IT] Sega universal • [ES] Sierra de sable • [PT] Serra sabre

**RD-RS32**
**NEW  
PRODUCT**

230V~ 50Hz	900 W	0-2800 min <sup>-1</sup>
5 mm	12mm AL	115 mm
	2.780 kg	

**QUICK CHANGE SYSTEM**

Art.No	gross weight	in cartoon	barcode
050131	3.000 kg	4 pcs	3800972016354

**RD-RS29**

230V~ 50Hz	750 W	900- 3300 min <sup>-1</sup>
8 mm	12mm AL	115 mm
	2.480 kg	

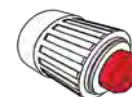
**QUICK CHANGE SYSTEM**

Art.No	gross weight	in cartoon	barcode
050129	2.880 kg	4 pcs	3800972010437

**RDP-RS28**

	230V~ 50Hz	
	850W	0-2800min <sup>-1</sup>
	VARIABLE SPEED	115mm
	6mm	
	2.920 kg	

**RAIDER®  
Pro**

**QUICK CHANGE SYSTEM**

**ROTATING HANDLE**

Art.No	gross weight	in cartoon	barcode
050202	3.260 kg	4 pcs	3800123173202



## MULTI-TOOL RD-OMT01

[BG] Многофункционален инструмент • [RO] Unealta multifunctionala • [SR] Višenamenski alat • [MK] Повекенаменски алат • [RU] Многофункциональный инструмент • [SL] Večnamensko orodje • [EL] Πολυεργαλείο μπαταρίας • [HR] Višenamjenski alat • [FR] Outil multifonctionnel • [IT] Multi-utensile oscillante • [ES] Herramienta multifuncional • [PT] Multi-ferramenta oscilante

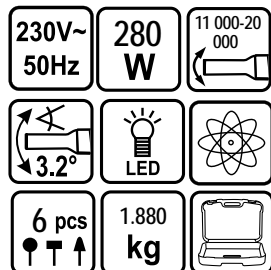

CUTTING AND GRINDING

Art.No	gross weight	in cartoon	barcode
050115	2.070 kg	5 pcs	3800123163623

## SANDER

[BG] Виброшлайф • [RO] Slefuitor cu vibratii • [SR] Brusilica vibraciona • [MK] Виброшлјаферница • [RU] Шлифмашина вибрационная • [SL] Vibracijski brusilnik • [EL] Τριβείο • [HR] Jednoručna brusilica • [FR] Ponceuse électrique • [IT] Sanderia elettrica • [ES] Elektra sandero • [PT] Lixadora

### RD-SA26



DUST AWAY SWITCH LOCK

Art.No	gross weight	in cartoon	barcode
040115	2.0 kg	10 pcs	3800972010413

### RD-SA08

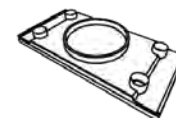

ALUMINIUM BASE



DUST AWAY SWITCH LOCK

Art.No	gross weight	in cartoon	barcode
040112	2.310 kg	8 pcs	3800123160813





# SANDER

[BG] Виброшлайф • [RO] Slefuitor cu vibratii • [SR] Brusilica vibraciona • [MK] Виброшлјаферица • [RU] Шлифмашина вибрационная • [SL] Vibracijski brusilnik • [EL] Τριβείο • [HR] Jednoručna brusilica • [FR] Ponceuse électrique • [IT] Sanderia elettrica • [ES] Elektra sandero • [PT] Lixadora

## RD-SA19

230V~ 50Hz	350 W	6000- 11000 min <sup>-1</sup>
DUST CAPTURE ПРАХО-УЛАВЉАЊЕ	2.440 kg	

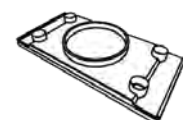

ALUMINIUM BASE



DUST AWAY

SWITCH LOCK

Art.No	gross weight	in carton	barcode
040111	1.710 kg	8 pcs	3800123151477

## RDP-SA22



**RAIDER®**  
*Pro*

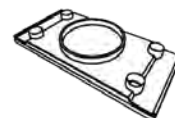

ALUMINIUM BASE



DUST AWAY

SWITCH LOCK

Art.No	gross weight	in carton	barcode
040401	2.060 kg	5 pcs	3800123167263

## RDP-SA23



**RAIDER®**  
*Pro*

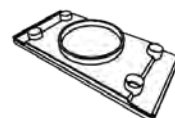

ALUMINIUM BASE



DUST AWAY

SWITCH LOCK

Art.No	gross weight	in carton	barcode
040402	2.620 kg	4 pcs	3800123167270

# RANDOM ORBIT SANDER

[BG] Ексцентършлайф • [RO] Slefuitor orbital • [SR] Brusilica rotaciona • [MK] Ексцентрична брусилка • [RU] Эксцентрикковые шлифовальные машины • [SL] Ekscentrični brusilnik • [EL] Εκκεντρο τρίβειο • [HR] Ekscentrična brusilica • [FR] Ponceuse excentrique • [IT] Levigatrice orbitale • [ES] Lijadora de órbita • [PT] Lixadora orbital

## RD-RSA05

**NEW  
PRODUCT**

230V~ 50Hz	450 W	6000- 11000 min <sup>-1</sup>
Ø 125 mm		
DUST CAPTURE ПРАХО- УЛАВЯНЕ	1.910 kg	

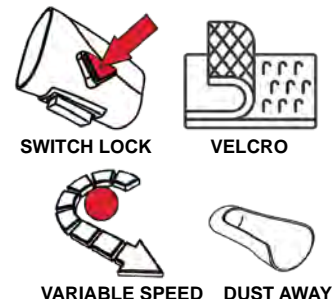

Art.No	barcode
040116	3800972016705

## RD-RSA03

230V~ 50Hz	420 W	6000- 11000 min <sup>-1</sup>
Ø 125 mm		
DUST CAPTURE ПРАХО- УЛАВЯНЕ	1.810 kg	

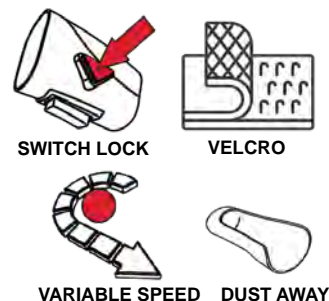

Art.No	gross weight	in carton	barcode
042102	2.220 kg	8 pcs	3800123151484

## RDP-RSA04

**RAIDER<sup>®</sup>  
Pro**

230V~ 50Hz	380W
6000-13000 min <sup>-1</sup>	Ø150mm
VELCRO	VARIABLE SPEED
DUST CAPTURE ПРАХО- УЛАВЯНЕ	2.200 kg

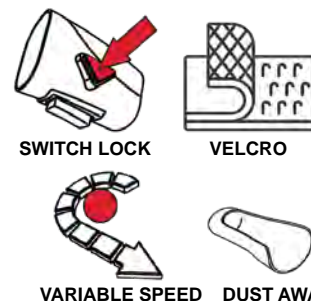

Art.No	gross weight	in carton	barcode
042201	2.450 kg	6	3800123167256



## BELT SANDER

[BG] Лентов шлиф • [RO] Slefuitor electric cu banda • [SR] Vibrirajuća brusilica • [MK] Шлиферица кружна • [RU] Шлифмашина ленточная • [SL] Tračni brusilnik • [EL] Ταλιοελιαντήρας • [HR] Tračna brusilica • [FR] Ponceuse à bande • [IT] Levigatrice a nastro • [ES] Litroj brusher • [PT] Lixadora

### RD-BS06

230V~ 50Hz	950 W	11500- 32000 min <sup>-1</sup>
75x533mm	150-380 m/min	
DUST CAPTURE ПРАХО- УЛАВЯНЕ	3.655 kg	



VARIABLE SPEED



COVER OPENING



DUST AWAY

Art.No	gross weight	in cartoon	barcode
043105	4.000 kg	6 pcs	3800123158957

### RDP-BS07

	230V~ 50Hz		1010W	120-380 m/min
	76x533 mm		VARIABLE SPEED	
	DUST CAPTURE ПРАХО-УЛАВЯНЕ		3.60 kg	



**RAIDER®**  
*Pro*



VARIABLE SPEED



COVER OPENING



DUST AWAY

Art.No	gross weight	in cartoon	barcode
043201	4.00 kg	6 pcs	3800123158940

## DRYWALL SANDER

[BG] Шлайфмашина за стени и тавани • [RO] Slefuitor pentru pereti • [SR] Brusilice za zid i plafon • [MK] Машина За полирање на сидови и плафони • [RU] Машинка шлифовальная • [SL] Brusilnik za stene • [EL] Τριβείο Τοίχων Γυψοσανίδας • [HR] Zidna brusilica • [FR] Ponceuse de cloison sèche • [IT] Levigatrice per cartongesso • [ES] Sander por muroj • [PT] Lixadora de parede

### RD-DS05

230V~ 50Hz	750 W	800 - 1750 min <sup>-1</sup>
	Ø 225mm	
DUST CAPTURE ПРАХО- УЛАВЯНЕ	4.500 kg	



VELCRO



DUST AWAY

Art.No	gross weight	in cartoon	barcode
049907	5.000 kg	1 pcs	3800972009202

RDP-DS02

**RAIDER<sup>®</sup>**  
**Pro**

230V~ 50Hz	710 W
450 - 1700 min <sup>-1</sup>	Ø 225 mm
LED	
DUST CAPTURE ПРАХО- УЛАВНЯНЕ	
6.7 kg	COLOR BOX

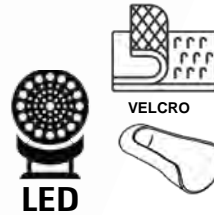

Art.No	gross weight	barcode
049903	7.800 kg	3800123166068

RD-DS06



230V~ 50Hz	750 W	800 - 1750 min <sup>-1</sup>
Ø 225 mm	LED	
DUST CAPTURE ПРАХО- УЛАВНЯНЕ	3.800 kg	COLOR BOX

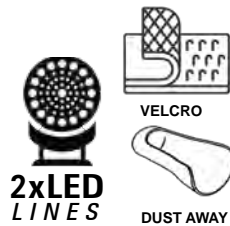

DUST BAG FOR DRYWALL SANDER RD-DS06



Art.No	gross weight	barcode
049908	2.100 kg	3800972010178

RD-DS03

2 HEADS



230V~ 50Hz	710 W	1200 - 2500 min <sup>-1</sup>
Ø 225 mm		
DUST CAPTURE ПРАХО- УЛАВНЯНЕ	6.7 kg	

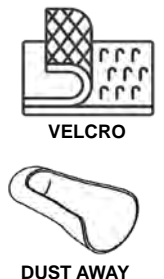

Art.No	gross weight	in cartoon	barcode
049904	7.500 kg	1 pcs	3800972002029



## CIRCULAR SAW

[BG] Циркулар ръчен • [RO] Fierastrau circular • [SR] Ručni cirkular • [MK] Циркулар рачен • [RU] Дисковая пила • [SL] Krožna žaga • [EL] Δίσκoς οτρίοιο • [HR] Ručna kružna pila • [FR] Meuleuse d'angle • [IT] Sega circolare • [ES] Amoladora angular • [PT] Serra circular

### RD-CS24

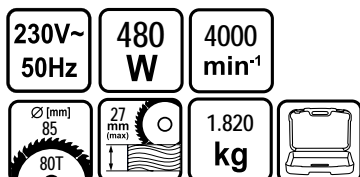

Art.No	gross weight	in cartoon	barcode
052108	3.580 kg	4 pcs	3800123166099

### RD-CS25

**FOR METAL  
AND WOOD**

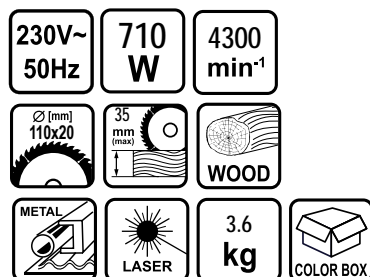

Art.No	gross weight	in cartoon	barcode
052109	4.000 kg	2 pcs	3800123167362

### RD-CS28

**NEW  
PRODUCT**

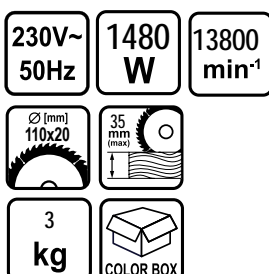

**MULTI  
PURPOSE**

- ▶ STONE
- ▶ TILES
- ▶ BRICKS
- ▶ CONCRETE
- ▶ MARBLE

Art.No	gross weight	in cartoon	barcode
052111	3.380 kg	8 pcs	3800972016323

# CIRCULAR SAW

[BG] Циркулар рѣчен • [RO] Fierastrau circular • [SR] Ručni cirkular • [MK] Циркулар рачен • [RU] Дисковая пила • [SL] Krožna žaga • [EL] Δίσκoς οτρίονο • [HR] Ručna kružna pila • [FR] Meuleuse d'angle • [IT] Sega circolare • [ES] Amoladora angular • [PT] Serra circular

## RD-CS210

230V~ 50Hz	1300 W
∅ (mm) 185x20x24T 80T	65 mm (max)
4700 min <sup>-1</sup>	0-45°
3.950 kg	LASER COLOR BOX



Art.No	gross weight	in cartoon	barcode
052106	3.580 kg	4 pcs	3800123159039

## RD-CS22

230V~ 50Hz	1500 W
∅ (mm) 190x20x24T 80T	70 mm (max)
4500 min <sup>-1</sup>	0-45°
4.020 kg	COLOR BOX



Art.No	gross weight	in cartoon	barcode
052201	4.760 kg	4 pcs	3800123159046

## RDP-CS26X

230V~ 50Hz	1350W	4700min <sup>-1</sup>
65 mm (max)	∅ (mm) 190x20	0-45°
4.16 kg	COLOR BOX	



Art.No	gross weight	in cartoon	barcode
052110	4.320 kg	4 pcs	3800123167621

**RAIDER<sup>®</sup>**  
*Pro*



# PLANER

[BG] Ренде електрическо • [RO] Rindea electrica • [SR] Električno rende • [MK] Рачен абрихтер • [RU] Рубанок • [SL] Utorni oblič • [EL] Ηλεκτρική πλάνη • [HR] Jednoručna blanja • [FR] Rabot électrique  
[IT] Pialla elettrica • [ES] Elektra ebenaĵo • [PT] Plana eléctrica

## RD-EP130

230V~ 50Hz	710 W	16 000 min <sup>-1</sup>
0-12mm	0-2 mm	82 mm
DUST CAPTURE ПРАХО- УЛАВЯНЕ	2.9 kg	COLOR BOX



ADJUSTABLE  
CUTTING DEPTH

Art.No	gross weight	in carton	barcode
055105	3.260 kg	6 pcs	3800123158933

## RD-EP12

230V~ 50Hz	850 W	16 000 min <sup>-1</sup>
0-12.5mm	0-3 mm	82 mm
DUST CAPTURE ПРАХО- УЛАВЯНЕ	3.1 kg	COLOR BOX



ADJUSTABLE  
CUTTING DEPTH



TWO SIDED  
DUST AWAY

Art.No	gross weight	in carton	barcode
055201	3.500 kg	6 pcs	3800123158926

## RDP-EP15

230V~ 50Hz	900W	0-3 mm	16 500 min <sup>-1</sup>	82 mm	3.67 kg	COLOR BOX
---------------	------	--------	--------------------------	-------	---------	-----------



**RAIDER®**  
*Pro*

WITH STAND



ADJUSTABLE  
CUTTING DEPTH

Art.No	gross weight	in carton	barcode
055202	4.650 kg	4 pcs	3800972016378

## RDP-EP10S

230V~ 50Hz	950W	0-4 mm	16 500 min <sup>-1</sup>	82 mm	3.67 kg	COLOR BOX
---------------	------	--------	--------------------------	-------	---------	-----------



**RAIDER®**  
*Pro*



ADJUSTABLE  
CUTTING DEPTH

Art.No	gross weight	in carton	barcode
055102	4.080 kg	6 pcs	3800123122927

# ROUTER

[BG] Оберфреза • [RO] Freza electrica • [SR] Glodalica • [MK] Фреза • [RU] Фрезер • [SL] Nadrezkar • [EL] Ηλεκτρικό router • [HR] Vertikalna glodalica • [FR] Électrique scie sauteuse • [IT] Router elettrico • [ES] Elektra router • [PT] Roteador elétrico

## RD-ER07

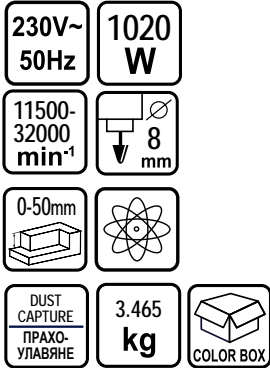

VARIABLE SPEED



DEPTH CONTROL

Art.No	gross weight	in cartoon	barcode
051102	4.260 kg	4 pcs	3800123124518

## RDP-ER13

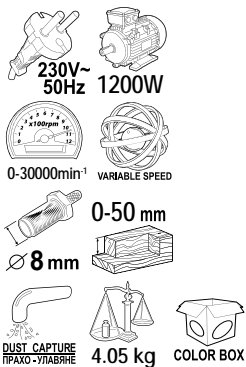

**RAIDER<sup>®</sup>**  
*Pro*



VARIABLE SPEED



DEPTH CONTROL

Art.No	gross weight	in cartoon	barcode
051108	4.500 kg	4 pcs	3800123162510

## ROUTER TABLE RD-RT01

[BG] Маса работна за оберфреза • [RO] Masa pentru frezare • [SR] Radni sto za glodalica • [MK] Маса работна за фрезер • [RU] Фрезеровочный стол • [SL] Delovna miza za nadrezkar • [EL] Τρόπέζι ρούτερ • [HR] Radni stol za glodalica • [FR] Table de routeur • [IT] Tavolo del router • [ES] Router-tablo • [PT] Mesa de fresa



Art.No	gross weight	in cartoon	barcode
059907	6.500 kg	4 pcs	3800123123467



**BISCUIT JOINTER RD-BJO1**

[BG] Фреза за плоски дибли (Бисквит Машина) • [RO] Freză pentru dibluri plate • [SR] Glodalica Za žljebove • [MK] Глодалка за жлеbove • [RU] Фрезы для плоских шкантов • [SL] Lamelni rezkalnik • [EL] Φρεζοκαθλιέρρα [HR] Glodalica za utore • [FR] Fraises pour chevilles plates • [IT] Frese per tasselli piatti • [ES] Trancillo por ebenaj dokaloj • [PT] Túpia angular

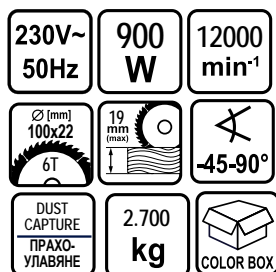

ADJUSTABLE  
CUTTING DEPTH

Art.No	gross weight	in cartoon	barcode
059906	6.000 kg	4 pcs	3800123123443

**ELECTRIC STAPLER**

[BG] Такер електрически комбиниран • [RO] Capsator electric • [SR] Heftalica električna • [MK] Хефталлица електрична • [RU] Электрический степлер • [SL] Električni spenjalnik • [EL] Ηλεκτρικό Συρραπτικό • [HR] Pištolj za klamerice • [FR] Agrafeuse électrique • [IT] Cucitrice meccanica elettrica • [ES] Elektra grapilo • [PT] Agrafador elétrico

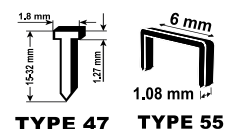
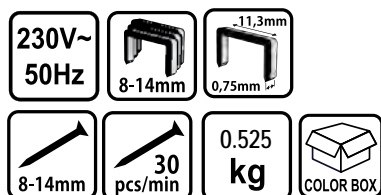
**RD-ES15**

Art.No	gross weight	in cartoon	barcode
129998	0.860 kg	10 pcs	3800123133725

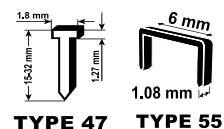
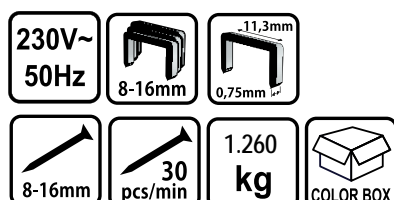
**RD-ES16**

Art.No	gross weight	in cartoon	barcode
059601	1.560 kg	10 pcs	3800123167959

# WET AND DRY VACUUM CLEANER

• [BG] Прахосмукачка за сухо и мокро • [RO] Aspirator umed/uscat • [SR] Usisivača za mokro i suvo • [MK] Правосмукалка за суво и мокро • [RU] Мокрый и сухой пылесос • [SL] Sesalnik za mokro in suho • [EL] Ηλεκτρική σκούπα για υγρή και ξηρή • [HR] Usisavač za mokre i suhe podloge • [FR] Aspirateur humide et sec • [IT] Aspirapolvere a umido ea secco • [ES] Malseca kaj seka malplena • [PT] Aspirador "WET & DRY"

## RD-WC08

230V~ 50Hz	1250 W
15L	1.3m <sup>3</sup> /min
VACUUM 15 kPa	2.0m
4 kg	
COLOR BOX	



**NEW  
PRODUCT**



**FOR DRY AND WET  
OPERATION**

Art.No	gross weight	barcode
090317	4.900 kg	3800972015869

## RD-WC01

230V~ 50Hz	1250 W
18L	1.3m <sup>3</sup> /min
VACUUM 16 kPa	2.3m
5.700 kg	
COLOR BOX	



HEPA FILTER

**VACUUM CLEANER BAGS RD-WC01**



Art.No	gross weight	barcode
090301	6.000 kg	3800123166990

Art.No	barcode
090306	380097200759

## RD-WC09

230V~ 50Hz	1250 W
20L	4.1m <sup>3</sup> /min
VACUUM 15 kPa	2.0m
4.600 kg	
COLOR BOX	



**NEW  
PRODUCT**



**FOR DRY AND WET  
OPERATION**

Art.No	gross weight	barcode
090318	5.500 kg	3800972015876

## RD-WC10

230V~ 50Hz	1250 W
20L	4.1m <sup>3</sup> /min
VACUUM 18 kPa	2.5m
5 kg	
COLOR BOX	



**NEW  
PRODUCT**



**INOX  
CONTAINER**



**FOR DRY AND WET  
OPERATION**

Art.No	gross weight	barcode
090321	5.500 kg	3800972015913



## WET AND DRY VACUUM CLEANER

[BG] Прахосмукачка за сухо и мокро • [RO] Aspirator umed/uscat • [SR] Usisivača za mokro i suvo • [MK] Правосмукалка за суво и мокро • [RU] Мокрый и сухой пылесос • [SL] Sesalnik za mokro in suho • [EL] Ηλεκτρική σκούπα για υγρή και ξηρή • [HR] Usisivač za mokre i suhe podloge • [FR] Aspirateur humide et sec • [IT] Aspirapolvere a umido ea secco • [ES] Malseka kaj seka malplena [PT] Aspirador "WET & DRY"

**RD-WC07**

**NEW  
PRODUCT**



Art.No	gross weight	in cartoon	barcode
090316	6.100 kg		3800972015852

**RDP-WC04**

**INOX**



HEPA FILTER

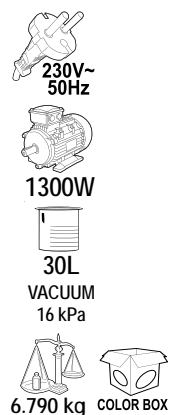

- Synchronizatin function
- Electrical socket for electric tools
- Water drain outlet
- **Hepa filter**
- Self-cleaning function
- Stainless steel container
- Metal telescopic tube
- Standard accessories

**RAIDER®  
Pro**



**VACUUM CLEANER BAGS RD-WC04**



Art.No	gross weight	barcode
090312	7.300 kg	3800972012622

Art.No	gross weight	barcode
090310	0.120 kg	3800972012622

**ASH VACUUM CLEANER RD-WC06**

[BG] Прахосмукачка за пепел • [RO] Aspirator pentru cenusa • [SR] Usisivač za pepeo • [MK] Правосмукалка за пепел • [RU] Пепла пылесос • [SL] Sesalnik pepela • [EL] Σκούπα φίλτρο σταχτήσ • [HR] Usisivač za uklanjanje pepela • [FR] Aspirateur de cendre • [IT] Aspirapolvere per cenere • [ES] Ash malplena • [PT] Aspirador de cinzas

**NEW  
PRODUCT**



**WITH BLOWER FUNCTION**



Art.No	gross weight	barcode
090314	3.800 kg	3800972015838

# ASH VACUUM CLEANER

[BG] Прахосмукачка за пепел • [RO] Aspirator pentru cenusa • [SR] Usisvač za pepeo • [MK] Правосмукалка за пепел • [RU] Пепла пылесос • [SL] Sesalnik pepela • [EL] Σκούπα φίλτρο σταχtis • [HR] Usisivač za uklanjanje pepela • [FR] Aspirateur de cendre • [IT] Aspirapolvere per cenere • [ES] Ash malplena • [PT] Aspirador de cinzas

## RD-WC02

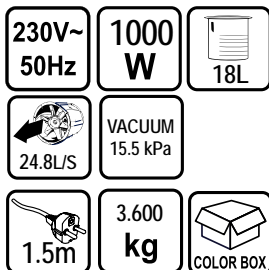

HEPA FILTER



METAL CONTAINER



TELESCOPIC PIPE

Art.No	gross weight	in cartoon	barcode
090304	4.300 kg	1	3800123173448

## RD-WC05

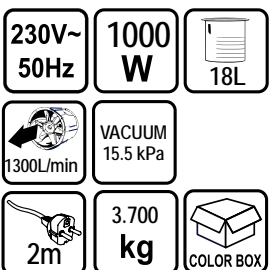

### WITH WHEELS



METAL CONTAINER



TELESCOPIC PIPE

Art.No	gross weight	in cartoon	barcode
090313	4.300 kg	1	3800972015821

## RD-WC03

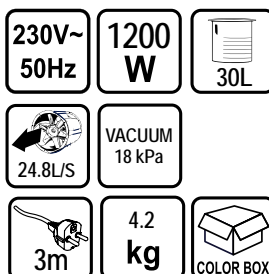

METAL CONTAINER



TELESCOPIC PIPE

Art.No	gross weight	in cartoon	barcode
090308	5.000 kg	1	3800972008823

## METAL ASH CLEANER WITH HEPA FILTER

[BG] Контейнер метален с HEPA филтър за прахосмукачка • [RO] Recipient pentru cenusa • [SR] Filter za pepeo • [MK] Сад за пепел • [RU] Контейнер для пепла для пылесос • [SL] Posoda za pepel • [EL] Φίλτρο στάχtis για Ηλεκτρική σκούπα • [HR] Posuda za pepeo • [FR] Aspirateur de cendre • [IT] Aspirapolvere per cenere • [ES] Ash malplena • [PT] Aspirador de cinzas



METAL CONTAINER



TELESCOPIC PIPE

Art.No	gross weight	in cartoon	barcode
090303	3.100 kg	1	3800123169694



# MITRE SAW

[BG] Циркулар настолен с двустранно наклоняне • [RO] Ferestrau circular • [SR] Pokretna kružna testera • [MK] Циркулар столен • [RU] Торцовочная пила • [SL] Radialna zajeralna žaga • [EL] Ηλεκτροκίνητο για ξύλο • [HR] Kružna pila • [FR] Scie à onglet • [IT] Formare sega • [ES] Formando sa • [PT] Serra de esquadria

## TABLE SAW RD-TS20

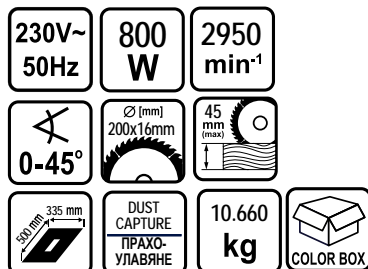

• Асинхронен електрически двигател  
• Asynchronous electric motor



Art.No	gross weight	barcode
054105	11.000 kg	3800123159220

## RD-MS02

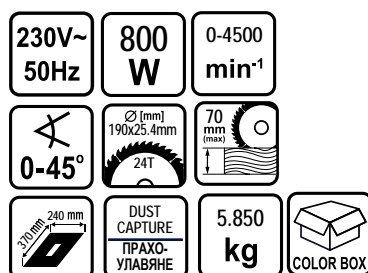

Art.No	gross weight	barcode
053100	6.500 kg	3800123154690

## RD-MS21

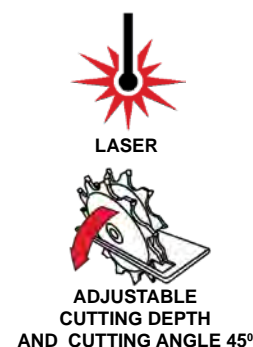
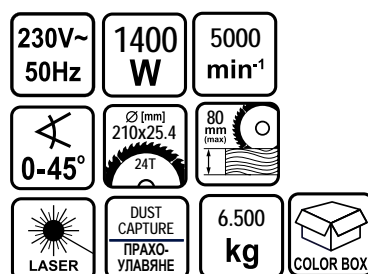

Art.No	gross weight	barcode
053102	8.000 kg	3800123123856

## RD-MS06

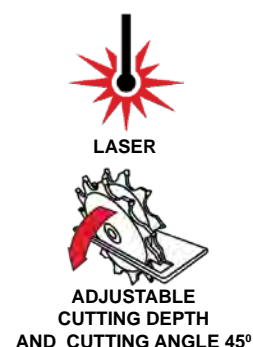
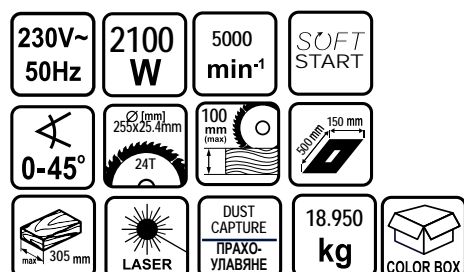

Art.No	gross weight	barcode
053104	20.000 kg	3800123123156

## COMBINATION TABLE AND MITRE SAW RD-MS10

[BG] Циркулар настолен комбиниран • [RO] Fierastrau circular semi-stationar si de masa • [SR] Testera kružna kombinovana stacionarna • [MK] Циркулар за дрво столен • [RU] Торцовочная пила • [SL] Radialna zajerlna žaga • [EL] Δισκοτόπινο Για Ξύλο • [HR] Potezno-nagibna pila • [FR] Banc de scie • [IT] Sega da tavolo • [ES] Tablo vidis • [PT] Serra de esquadria

230V~ 50Hz	1200 W	4500 min <sup>-1</sup>	0-45°
∅ [mm] 210x30mm 24T	45-85 mm (max)	300 mm 265 mm	
DUST CAPTURE ПРАХО- УЛАВЯНЕ	10.400 kg	COLOR BOX	



TABLE SAW OPTION



LASER



ADJUSTABLE  
CUTTING DEPTH  
AND CUTTING ANGLE 45°

Art.No	gross weight	in cartoon	barcode
054104	12.060 kg	1	3800123141911

## MITRE SAW DOUBLE BEVEL RDP-MS11

[BG] Циркулар настолен с двустранно наклоняне • [RO] Ferestrau circular • [SR] Pokretna kružna testera • [MK] Циркулар столен • [RU] Торцовочная пила • [SL] Radialna zajerlna žaga • [EL] Ηδισκοτόπινο για ξύλο • [HR] Kružna pila • [FR] Scie à onglet • [IT] Formare sega • [ES] Formando sa • [PT] Serra de esquadria

230V~ 50Hz	2100W	100 mm (max)	4500 min <sup>-1</sup>	∅ [mm] 305x30	100T	330 mm	0-45°	LASER	SOFT START
DUST CAPTURE ПРАХО-УЛАВЯНЕ	16.00 kg	COLOR BOX							



**RAIDER**  
Pro



LASER



ADJUSTABLE  
CUTTING DEPTH  
AND CUTTING ANGLE 45°

Art.No	gross weight	in cartoon	barcode
053108	20.000 kg	1	3800972010109



**BAND SAW RD-BSW18**

[BG] Банциг • [RO] Ferestrau pendular de banc • [SR] Trakasta testera • [MK] Трачна пила • [RU] Ленточная пила • [SL] Траčna žaga • [EL] Приονοκορδέλα • [HR] Трачна пила • [FR] Scie à ruban • [IT] Sega a nastro • [ES] Bando vidis • [PT] Serra de mesa

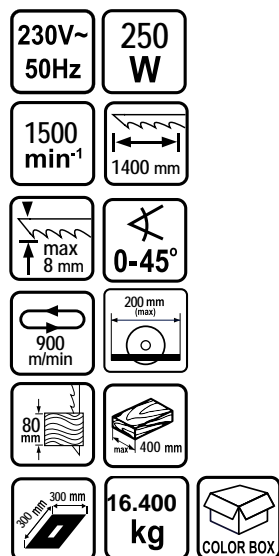

• Асинхронен електрически двигател  
• Asynchronous electric motor



ADJUSTABLE  
CUTTING DEPTH  
AND CUTTING ANGLE 45°

Art.No	gross weight	in cartoon	barcode
059902	18.500 kg	1	3800123162176

**WOOD LATHE RD-WL03T**

[BG] Струг за дърво • [RO] Strung pentru lemn • [SR] Glodalica za drvo • [MK] Струг за дрво • [RU] Токарный станок по дереву • [SL] Lesna stružnica • [EL] Ξύλουργικός τόρνος • [HR] Tokarilica za drvo • [FR] Tour à bois • [IT] Tornio di legno • [ES] Tornilo de ligno • [PT] Torno p/ madeira

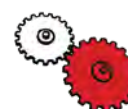
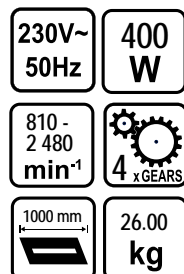

FOUR GEARS

Art.No	gross weight	barcode
059905	24.000 kg	3800123124952

**SCROLL SAW RD-SS16J**

[BG] Машина за изрязване на орнаменти • [RO] Ferestrau de banc • [SR] Трачна testera • [MK] Машина за изрязување на украси • [RU] Выделителе пила • [SL] Električna rezbarska žaga • [EL] Приονοκορδέλες • [HR] Stroj za rezanje ornamentima • [FR] Scie à chantourner • [IT] Scorri sega • [ES] Scroll vidis • [PT] Serra de rolagem

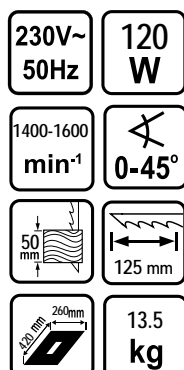

• Асинхронен електрически двигател  
• Asynchronous electric motor



ADJUSTABLE  
CUTTING DEPTH  
AND CUTTING ANGLE 45°

Art.No	gross weight	in cartoon	barcode
059903	15.000 kg		3800123124945

# TABLE SAW WITH EXTENSION WINGS AND STAND

[BG] Циркулар стационарен • [RO] Fierastrau circular de banc • [SR] Testera kružna stacionarna • [MK] Потезна-комбинирана пила • [RU] Настольная пила • [SL] Stabilna in kotna žaga • [EL] Δίσκοπριονο • [HR] Stolna kružna pila • [FR] Scie à table avec rallonges et support • [IT] Sega da tavolo con ali di estensione e supporto • [ES] Tablo vidis per extendaj flugiloj kaj staras • [PT] Serra circular de bancada c/ abas extensíveis e suporte

## RD-TS12B

230V~ 50Hz	2200 W
4800 min <sup>-1</sup>	∅ (mm) 254x30mm 24T
85 mm (max)	555 mm 575mm
0-45°	DUST CAPTURE ПРАХО-УЛАВЯНЕ
21.00 kg	COLOR BOX

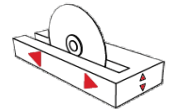

**MAXIMUM DEPTH**  
740 mm



**ADJUSTABLE CUTTING DEPTH AND CUTTING ANGLE 45°**

Art.No	gross weight	barcode
059403	25.600 kg	3800123160738

## RD-TS10

230V~ 50Hz	2000 W
2950 min <sup>-1</sup>	∅ (mm) 315x30mm 36T
90 mm (max)	550 mm
0-45°	DUST CAPTURE ПРАХО-УЛАВЯНЕ
48.00 kg	COLOR BOX

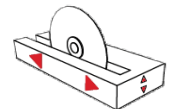

**MAXIMUM DEPTH**  
900 mm



**ADJUSTABLE CUTTING DEPTH AND CUTTING ANGLE 45°**

Art.No	gross weight	barcode
053105	52.000 kg	3800123123207

## COMBINED MITRE AND BENCH SAW RDP-TS11

[BG] Циркулар стационарен комбиниран • [RO] Fierastrau circular de banc • [SR] Testera kružna stacionarna • [MK] Потезна-комбинирана пила • [RU] Настольная пила • [SL] Stabilna in kotna žaga • [EL] Δίσκοπριονο • [HR] Stolna kružna pila • [FR] Scie à onglet et banc combinée • [IT] Mitra e sega da banco combinate • [ES] Kombinita mitro kaj benko vidis • [PT] Serra de esquadria

230V~ 50Hz	2200W
3100 min <sup>-1</sup>	∅ (mm) 250x30x42T
70 mm (max)	45°
DUST CAPTURE ПРАХО-УЛАВЯНЕ	38.25 kg
	COLOR BOX



**RAIDER<sup>®</sup>**  
Pro



**BEVEL CUT**  
0-45°

Art.No	gross weight	barcode
059401	42.500 kg	3800123158988



## ELECTRIC LOG CUTTING SAW RD-LS01

[BG] Циркулар за рязане на дърва • [RO] Circular cu suport pentru lemne foc • [SR] Testera Kružna Stacionarna • [MK] Пила за сечење на дрва • [RU] Дисковая пила для резки дерева • [SL] Krožna žaga za razrez lesa • [EL] Δισκοπριονα Κοπής Καυσόξυλων • [HR] Kružna pila za piljenje drva • [FR] Scie à bois électrique • [IT] Troncatrice elettrica per tronchi • [ES] Elektra registra kortego • [PT] Serra de corte de toras elétrica

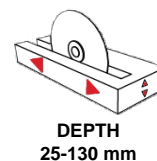
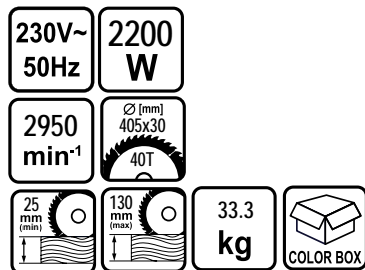

Art.No	gross weight	in cartoon	barcode
129940	37.000 kg		3800123168475

## COMBINED WOODWORKING MACHINE RDP-CWM01

• [BG] Машина дървообработваща мултифункционална • [RO] Masina combinata pentru tamplarie • [SR] Kombinovana mašina za obradu drveta • [MK] Комбинирана машина за дрво • [RU] Настольная пила • [SL] Stabilna in kotna žaga • [EL] Δισκοπριονο • [HR] Višenamjenski stroj za drvo • [FR] Machine à bois combinée • [IT] Macchina per la lavorazione del legno combinata • [ES] Kombinita lignaj mašinoj • [PT] Máquina universal p/ carpintaria



**RAIDER®**  
Pro

Awarded with a gold medal

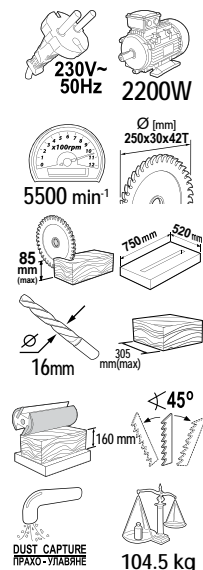

CIRCULAR OPTION



PLANING OPTION



DRILL OPTION



Art.No	gross weight	in cartoon	barcode
059402	108.500 kg		3800123158995

## DUST COLLECTOR RD-DC01Q

• [BG] Прахоуловител • [RO] Aspirator de praf • [SR] Skupljač Prašine • [MK] Правосмукалак • [RU] Пыле уловитель • [SL] Industrijski sesalnik • [EL] Απορροφητήρας Σκονής • [HR] Usisavač za prašinu • [FR] Collecteur de poussière • [IT] Aspirapolvere • [ES] Polva kolektanto • [PT] Saco p/ lixadora de parede





• Асинхронен електрически двигател  
• Asynchronous electric motor.

Art.No	gross weight	barcode
059908	21.500 kg	3800123123474

# CUT OFF MACHINE

[BG] Циркулар за метал • [RO] Fierastrau circular (metal) • [SR] Testera kružna za metal stacionarna • [MK] Циркулар за дрво стoлен • [RU] Торцовочная пила по метал • [SL] Rezalni brusilnik • [EL] Λεϊοντήρας κοπής • [HR] Rezna brusilica • [FR] Machine coupée • [IT] Tagliare la macchina • [ES] Trancú maşinon • [PT] Máquina cortada

## RD-CM06

230V~ 50Hz	2000 W
3700 min <sup>-1</sup>	355 mm
25,4 mm	17.800 kg
	



CUT PRECISION





Ø 355 mm

Art.No	gross weight	barcode
060106	18.500 kg	3800123158650

## RD-CM08

**NEW  
PRODUCT**

230V~ 50Hz	2400 W
3700 min <sup>-1</sup>	355 mm
25,4 mm	16.950 kg
	



CUT PRECISION

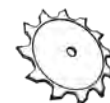



Ø 355 mm

Art.No	barcode
060108	3800972016330

# BENCH GRINDER

[BG] Шмъргел • [RO] Polizor de banc • [SR] Stona Brusilica • [MK] Струг • [RU] Станок Точильный • [SL] Dvojni Brusilnik • [EL] Δίδυμοι τροχοί πάγκου • [HR] Dvostrana stolna brusilica • [FR] Meuleuse de table • [IT] Smerigliatrice da banco • [ES] Benka muelilo • [PT] Esmeriladora

## RD-BG01

230V~ 50Hz	150 W
2950 min <sup>-1</sup>	12,7 mm
4.320 kg	
	



ELECTROMAGNETIC  
SWITCH



WHEEL  
DRESSER

Art.No	gross weight	barcode
061102	4.800 kg	3800123124099



## BENCH GRINDER

[BG] Шмиргел • [RO] Polizor de banc • [SR] Stona Brusilica • [MK] Струг • [RU] Станок Точильный • [SL] Dvojni Brusilnik • [EL] Δίδυμοι τροχοί πάγκου • [HR] Dvostrana stolna brusilica • [FR] Meuleuse de table • [IT] Smerigliatrice da banco • [ES] Benka muelilo • [PT] Esmeriladora

### RDP-BG04

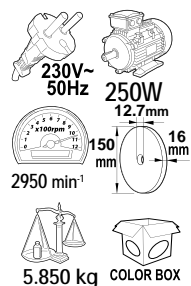
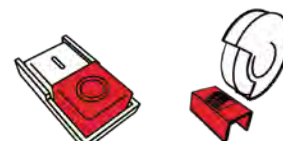
**RAIDER®**  
Pro

**ELECTROMAGNETIC SWITCH**      **WHEEL DRESSER**

Art.No	gross weight	barcode
061101	6.500 kg	3800123123825

### RDP-BG02

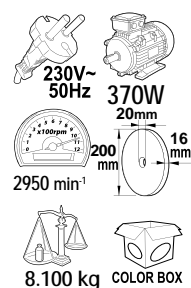

**RAIDER®**  
Pro

**ELECTROMAGNETIC SWITCH**      **WHEEL DRESSER**

Art.No	gross weight	barcode
061103	9.000 kg	3800123124204

### BENCH GRINDER RDP-BG03

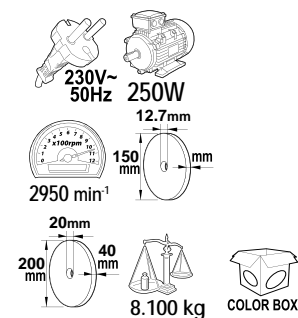
[BG] Шмиргел редукторен • [RO] Polizor de banc • [SR] Stona Brusilica • [MK] Струг • [RU] Станок точильный • [SL] Dvojni brusilnik • [EL] Δίδυμοι τροχοί πάγκου • [HR] Dvostrana stolna brusilica • [FR] Meuleuse de table • [IT] Smerigliatrice da banco • [ES] Benka muelillo • [PT] Esmeriladora



**RAIDER®**  
Pro

**ELECTROMAGNETIC SWITCH**      **WHEEL DRESSER**

Art.No	gross weight	barcode
061104	9.000 kg	3800123124273

### BENCH GRINDER - SANDER RDP-BG05

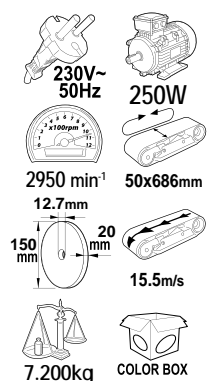
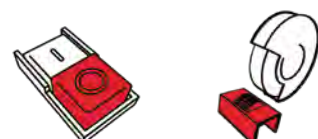
[BG] Шмиргел с лентов шлайф • [RO] Polizor de banc - Slefuitor • [SR] Stona Brusilica • [MK] Струг • [RU] Станок Точильный • [SL] Dvojni brusilnik • [EL] Δίδυμοι τροχοί πάγκου • [HR] Dvostrana stolna brusilica • [FR] Meuleuse d'établi - Ponceuse • [IT] Smerigliatrice da banco - levigatrice • [ES] Benka Muelillo - sander • [PT] Esmeriladora



**RAIDER®**  
Pro

**ELECTROMAGNETIC SWITCH**      **WHEEL DRESSER**

Art.No	gross weight	barcode
061105	8.000 kg	3800123123108

## BENCH GRINDER WITH MINI GRINDER RD-BG06

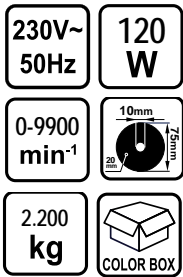
[BG] Шмиргел с мини шлифовалка • [RO] Polizor de banc cu mini polizor drept • [SR] Stona brusilica sa brusilica deona • [MK] Струг и брусилка со осило • [RU] Станок точильный с мини шлифмашина  
[SL] Dvojni brusilnik s mini brusilnik • [EL] Δίδυμοι τροχοί πάγκου μίνι τροχείο • [HR] Dvostrana stolna brusilica s ravna brusilica • [FR] Meuleuse de table avec mini meuleuse • [IT] Smerigliatrice da banco con mini smerigliatrice • [ES] Benka muelillo kun mini muelillo • [PT] Esmeriladora



Art.No	gross weight	in cartoon	barcode
129928	2.500 kg	4 pcs	3800123123450



## POLISHER

[BG] Полирмашина • [RO] Masina de polishat • [SR] Polirka ugaona • [MK] Полирка • [RU] Электрический полировщик • [SL] Kotni polirni stroj • [EL] Γωνιακος λειαντης • [HR] Brusilica za poliranje  
• [FR] Polisseuse • [IT] Lucidatrice • [ES] Elektra polisilo • [PT] Polidora

### RD-PC04T

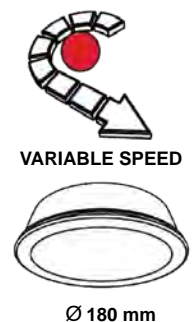
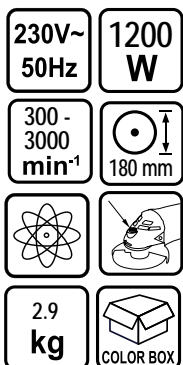

Art.No	gross weight	in cartoon	barcode
045102	3.260 kg	2 pcs	3800123124167



**RD-PC03**

230V~ 50Hz	110 W
3100 min <sup>-1</sup>	240 mm
2.100 kg	COLOR BOX



Ø 240 mm

Art.No	gross weight	in cartoon	barcode
045101	2.650 kg	4 pcs	3800123124419

**BURNISHING MACHINE RDP-BM01**

[BG] Шлайф ролков • [RO] Masina de polishat • [SR] Polirka • [MK] Полирка • [RU] Машина шлифовальная щеточная • [SL] Satinirka • [EL] Γωνιακος Λειαντης • [HR] Brusilica za poliranje • [FR] Satineuse Trinoflex • [IT] Satinatrice • [ES] Satinadora • [PT] Polidora



Art.No	barcode
041601	3800972019676

230V~ 50Hz	2100 W
3000 min <sup>-1</sup>	COLOR BOX

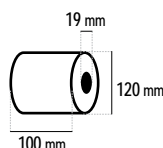

**POLISHING FLEECE WHEEL**  
middle grit ◆◆◆◆◆



Art.No	barcode
155802	3800972019669

**MINI GRINDER SET RD-MG07**

[BG] Шлифовалка права с 40 аксесоара • [RO] Mini polizor drept • [SR] Brusilica deona 40 kom pribora • [MK] Рамна брусилка со додаточи • [RU] Мини шлифмашина • [SL] Mini brusilnik • [EL] Μίνι Τροχέιο • [HR] Ravna brusilica • [FR] Mini meuleuse set 40 accessoires • [IT] Mini grinder set 40 accessori • [ES] Mini-muellillo aro 40 akcesorajoj • [PT] Kit mini multifunções c/ 40 acessórios

230V~ 50Hz	160 W
5000- 35000 min <sup>-1</sup>	2.4 / 3.2 Ømm
40 pcs	COLOR BOX
0.820 kg	



VARIABLE SPEED

Art.No	gross weight	in cartoon	barcode
044105	1.020 kg	10 pcs	3800123166082

**MINI GRINDER SET FLEXIBLE SHAFT RD-MG06D**

[BG] Шлифовалка права с жило 210 аксесоара • [RO] Mini polizor drept • [SR] Brusilica deona 210 kom pribora • [MK] Рамна брусилка со додаточи • [RU] Мини шлифмашина • [SL] Mini brusilnik • [EL] Μίνι Τροχέιο • [HR] Ravna brusilica • [FR] Mini meuleuse set 210 accessoires • [IT] Mini grinder set 210 accessori • [ES] Mini-muellillo aro 210 akcesorajoj • [PT] Kit mini multifunções c/ 210 acessórios

230V~ 50Hz	135 W
10000- 32000 min <sup>-1</sup>	2.4 / 3.2 Ømm
210 pcs	COLOR BOX
1.700 kg	



VARIABLE SPEED

Art.No	gross weight	in cartoon	barcode
044104	2.000 kg	5 pcs	3800123124242

## MINI GRINDER SET FLEXIBLE SHAFT, TOOL HOLDER RD-MG09

[BG] Шлифовалка права с жило 126 аксесоара • [RO] Mini polizor drept • [SR] Brusilica беопа 126 ком прибора • [MK] Рамна брусилка со додаточи • [RU] Мини шлифмашина • [SL] Mini brusilnik • [EL] Μίνι Τροχέιο • [HR] Ravna brusilica • [FR] Mini meuleuse set 126 accessoires • [IT] Mini grinder set 126 accessori • [ES] Mini-muelillo aro 126 akcesorajoj • [PT] Kit mini multifunções c/ 126 acessórios

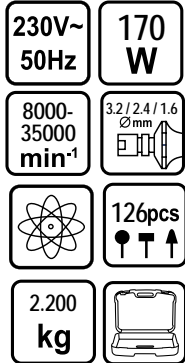

Art.No	gross weight	in cartoon	barcode
044107	2.760 kg	6 pcs	3800123170782

## ENGRAVER RD-ENG01

[BG] Уред за гравирание • [RO] Masina de gravat • [SR] Uredaj za graviranje • [MK] Апарат за гравирање • [RU] Машина для гравировки • [SL] Ročni gravirnik • [EL] Εργαλείο χαρακτικής • [HR] Alat za graviranje • [FR] Graveur • [IT] Incisore • [ES] Gravuristo • [PT] Gravadora

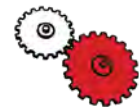
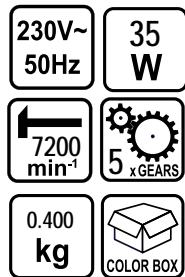

Art.No	gross weight	in cartoon	barcode
044108	0.500 kg	20 pcs	3800123172625



## ELECTRIC SPRAY GUN

[BG] Пистолет за боя • [RO] Pistol de vopsit • [SR] Pištolj za farbanje električni • [MK] Електричен пистол за фарбање • [RU] Краскопулт электрический • [SL] Električna razpršilna pištola • [EL] Πιστόλι βαφής ηλεκτρικό • [HR] Pištolj Za prskanje zidne boje • [FR] Pistolet électrique • [IT] Pistola a spruzzo elettrica • [ES] Elektra sprayilo • [PT] Pistola de pintura eléctrica

### RDP-ESG11P

**RAIDER®**  
**Pro**

DUSE DIAMETER  
Ø 0.8 mm



CONTAINER CAPACITY  
700 ml

Art.No	gross weight	in cartoon	barcode
129952	2.120 kg	4 pcs	3800123127861

## ELECTRIC SPRAY GUN WITH COMPRESSOR

[BG] Пистолет за боя с ел. компресор • [RO] Pistol de vopsit cu compresor • [SR] Pištolj za farbanje sa kompresorom • [MK] Пистол за боја со компресор • [RU] Краскопулт с электрическим компрессором • [SL] lakirna pištola • [EL] Πιστόλι Βαφής ηλεκτρικό Κομπρεσεер • [HR] Sustav Za Prskanje Boje • [FR] Pistolet de pulvérisation avec compresseur électrique • [IT] Pistola a spruzzo con compressore elettrico • [ES] Špruca pafilo per elektra kompresoro • [PT] Pistola de pintura com compressor elétrico

### RD-SGC09



DUSE DIAMETER  
Ø 1.5, 1.8, 2.2, 2.6 mm



CONTAINER CAPACITY  
1000 ml

Art.No	gross weight	in cartoon	barcode
074107	1.790 kg		3800972015166

### RD-SGC06



DUSE DIAMETER  
Ø 2.5 mm



CONTAINER CAPACITY  
9000 ml

Art.No	gross weight	in cartoon	barcode
074105	3.220 kg	4 pcs	3800123167850

*Strap for comfortable and easy carrying*

## RD-SGC04

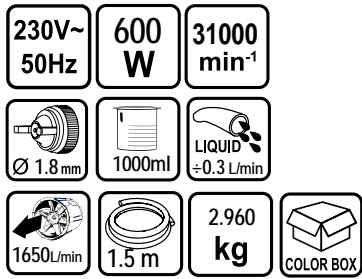

**DUSE DIAMETER**  
 Ø 1.8 mm



**CONTAINER CAPACITY**  
 1000 ml

Art.No	gross weight	in cartoon	barcode
074103	3.500 kg	4 pcs	3800123162206

## RDP-SGC08

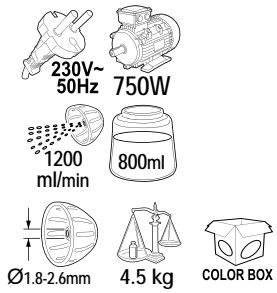

**DUSE DIAMETER**  
 Ø 1.8-2.6 mm



**CONTAINER CAPACITY**  
 800 ml

Art.No	gross weight	in cartoon	barcode
074201	4.080 kg	6 pcs	3800123162206





## HEAT GUN

[BG] Пистолет за горещ въздух • [RO] Pistol cu aer cald • [SR] Pištoľ za vrelı vazduh • [MK] Фен • [RU] Пистолет горячего воздуха • [SL] Vroca zrasna pištoľa • [EL] Πιστολι φερμου αερα • [HR] Pištoľ za vrući zrak • [FR] Arbre à air chaud • [IT] Pistola aria calda • [ES] Pistola de aire caliente • [PT] Soprador de ar quente

### RD-HG17

230V~ 50Hz	2000 W
I-300l/min II-500l/min	I-350°C II-550°C
0.790 kg	 COLOR BOX



TEMPERATURE  
ADJUSTMENT

Art.No	gross weight	in cartoon	barcode
074306	0.880 kg	10 pcs	3800972001862

### RD-HG14

230V~ 50Hz	2000 W
I-250l/min II-550l/min	I-250°C II-550°C
5 pcs 	0.9 kg



TEMPERATURE  
ADJUSTMENT

Art.No	gross weight	in cartoon	barcode
074302	1.000 kg	10 pcs	3800123162916

### RD-HG18

230V~ 50Hz	2000 W
I-240l/min II-480l/min	I-80-300°C II-80-600°C
1.580 kg	



TEMPERATURE  
ADJUSTMENT

Art.No	gross weight	in cartoon	barcode
074307	1.760 kg	5 pcs	3800972001954

### RD-HG22

230V~ 50Hz	2000 W
I-300l/min II-500l/min	I-350°C II-550°C
0.800 kg	



TEMPERATURE  
ADJUSTMENT

Art.No	gross weight	in cartoon	barcode
074311	1.660 kg	10 pcs	3800972002500

## RD-HG12



230V~ 50Hz	2000 W
I - 240 l/min	I - 80-300 °C
II - 480 l/min	II - 80-600 °C
0.790 kg	



TEMPERATURE  
ADJUSTMENT

Art.No	gross weight	in cartoon	barcode
122105	2.000 kg	5 pcs	3800123143885

## RD-HG23





230V~ 50Hz	2000 W
I - 300 l/min	I - 50 °C
II - 300 l/min	II - 70 - 600 °C
III - 500 l/min	III - 70 - 600 °C
LCD DISPLAY	5 pcs 
1.490 kg	



TEMPERATURE  
ADJUSTMENT

Art.No	gross weight	in cartoon	barcode
074312	1.660 kg	10 pcs	3800972002517

## RDP-HG21

	
230V~ 50Hz	2000W
I - 350 l/min	I - 60 °C
II - 350 l/min	II - 60 - 350 °C
III - 500 l/min	III - 350 - 550 °C
5 pcs 	LCD DISPLAY
	
1.22 kg	COLOR BOX







**RAIDER®**  
Pro



TEMPERATURE  
ADJUSTMENT

Art.No	gross weight	in cartoon	barcode
074310	1.360 kg	10 pcs	3800972002494

## RDP-HG16

	
230V~ 50Hz	2000W
I - 120 - 550 l/min	I - 50 °C
II - 120 - 550 l/min	II - 50 - 630 °C
III - 550 l/min	III - 50 - 630 °C
5 pcs 	LCD DISPLAY
	
1.89 kg	COLOR BOX



**RAIDER®**  
Pro

LCD  
DISPLAY



TEMPERATURE  
ADJUSTMENT

Art.No	gross weight	in cartoon	barcode
074305	2.110 kg	6 pcs	3800123166877



**ELECTRIC WEED BURNER RD-HG20**

[BG] Пистолет за горещ въздух • [RO] Arzator electric de buruieni • [SR] Pištolj za vreli vazduh • [MK] Фен •

[RU] Пистолет горячего воздуха • [SL] Vroca zracna pištola • [EL] Πιστολι φερμου αερα • [HR] Pištolj za vrući zrak • [FR] Arbre à air chaud • [IT] Pistola aria calda • [ES] Pistola de aire caliente • [PT] Ar quente

230V~  
50Hz

2000  
W

650°C

1.400  
kg



COLOR BOX



Art.No	gross weight	in cartoon	barcode
074309	1.690 kg	8 pcs	3800972001978

**PPR PIPE WELDING SET**

[BG] Поялник за PP тръби 3 глави • [RO] Dispozitiv pentru lipit tevi PPR set • [SR] Pegla za plastične cevi • [MK] Греалка за пластични цевки • [RU] Пааяльник для сварки пропиленовых труб • [SL]

Srajkalnik polipropilena • [EL] Μηχάνημα συγκόλλησης πλαστικών • [HR] Aparat za varenje PPR cijevi • [FR] Fer à souder pour le soudage de tubes en propylène • [IT] Saldatore per saldatura di tubi in propilene • [ES] Solda ferro por veldi pipojn de propileno • [PT] Kit soldadora de PPR

**RD-PW01**
**3 SOCKETS**

230V~  
50Hz

800  
W

50-300  
°C

Ø mm  
20, 25,  
32

3 pcs  
⬆ ⬆ ⬆

3.395  
kg



DIAMETER  
Ø 20, 25, 32 mm

Art.No	gross weight	in cartoon	barcode
123103	4.170 kg	6 pcs	3800123123023

**RD-PW02**
**6 SOCKETS**

230V~  
50Hz

1000  
W

50-300  
°C

Ø mm  
20,25,32,40,  
50,63

6 pcs  
⬆ ⬆ ⬆

2.7  
kg



DIAMETER  
Ø 20, 25, 32, 40, 50, 63 mm

Art.No	gross weight	in cartoon	barcode
123104	3.000 kg	6 pcs	3800123123054

## SOLDERING IRON SHARP TIP

[BG] Поялник с остър връх • [RO] Letcon • [SR] Lemilica • [MK] Пиштол за лемење [RU] Универсальный паяльник • [SL] Spajkalnik • [EL] Κολλητήρι • [HR] Lemilica Tanki Vrh • [FR] Fer à souder universel • [IT] Saldatore universale • [ES] Universala solderilo • [PT] Soldador

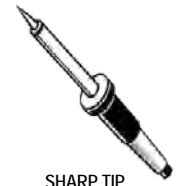

SHARP TIP

art. №	W	weight kg	BARCODE
123107 RD-SI01J	40	0.255	3800123143854
076401 RD-SI02J	60	0.255	3800123159145
076402 RD-SI03J	80	0.290	3800123159152



## SOLDERING IRON FLAT TIP RD-SI04J

[BG] Поялник плосък връх прав • [RO] Letcon • [SR] Lemilica • [MK] Пиштол за лемење [RU] Универсальный паяльник • [SL] Spajkalnik • [EL] Κολλητήρι • [HR] Lemilica Tanki Vrh • [FR] Fer à souder universel • [IT] Saldatore universale • [ES] Universala solderilo • [PT] Soldador

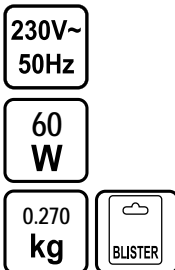

FLAT TIP

Art.No	gross weight	in cartoon	barcode
076403	0.260 kg	50 pcs	3800123159169

## SOLDERING IRON FLAT BENT TIP RD-SI05J

[BG] Поялник плосък връх извит • [RO] Letcon • [SR] Lemilica • [MK] Пиштол за лемење [RU] Универсальный паяльник • [SL] Spajkalnik • [EL] Κολλητήρι • [HR] Lemilica Tanki Vrh • [FR] Fer à souder universel • [IT] Saldatore universale • [ES] Universala solderilo • [PT] Soldador

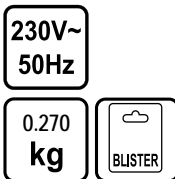

FLAT BENT TIP

Art.No	gross weight	W	in cartoon	barcode
076404	0.270 kg	60	50 pcs	3800123159176
076409	0.270 kg	100	50 pc	3800972018907

## SOLDERING IRON, TIN ABSORPTION PUMP, TIN KIT

[BG] Поялник, Помпа за калай, Тинол паста к-т • [RO] Set lipire Letcon, Pompa, Fludor • [SR] Lemilica, Apsorcija pumpe, Pasta za lemljenje • [MK] Пиштол за лемење, Пумпа за калај, Паста за лемење к-т • [RU] Паяльник, Насос олова, Паяльная паста Набор • [SL] Spajkalnik, črpalka za kositer, Pasta za spajkanje Set • [EL] Κολλητήρι, Αποκόλλησης της αντλίας, πάστα συγκόλλησης • [HR] Lemilica, Pumpicu Za Odlemljivanje, pasta za lemljenje k-t • [FR] Fer à souder, pompe d'absorption d'étain, kit d'étain • [IT] Saldatore, pompa di assorbimento dello stagno, kit di stagno • [ES] Soldanta Ferro, Stana Absorbado-Bombo, Stana llaro • [PT] Ferro de solda, Bomba de absorção de estanho, Kit de estanho

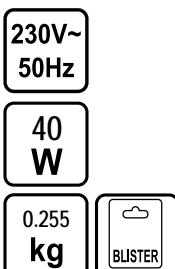

Art.No	gross weight	in cartoon	barcode
076406	0.400 kg	30 pcs	3800123166952



## SOLDERING GUN

[BG] Паялник индукционен • [RO] Pistol pentru lipit • [SR] Lemilica • [MK] Пиштол за лемене • [RU] Универсальный паяльник • [SL] Sprajkalnik • [EL] Κολλητήρι • [HR] Lemilica pištoľ • [FR] Fer à souder universel • [IT] Pistola per saldatura • [ES] Soldanta pafilo • [PT] Pistola de soldar



LED

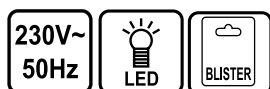

art. №	W	weight kg	°C	BARCODE
076407 RD-SOG03	100	0.600	600	3800123166969
123105 RD-SOG02	175	0.720	600	3800123123818

## SOLDERING IRON STATION RD-SISO1

[BG] Станция за запояване • [RO] Stație de lipit • [SR] Stanica za lemjenje • [MK] Лемна станица • [RU] Паяльная станция • [SL] Sprajkalne postaje • [EL] Συγκόλληση σταθμό • [HR] Stanica za lemjenje • [FR] Station de soudure • [IT] Stazione di saldatura • [ES] Soldanta stacio • [PT] Estação de soldar

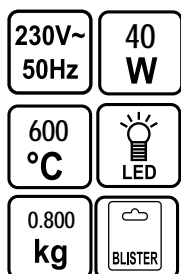

LED

Art.No	gross weight	in cartoon	barcode
076408	0.660 kg	20 pcs	3800123166976

## TIN ABSORPTION PUMP

[BG] Помпа за калай • [RO] Pompa absorbtie fludor • [SR] Apsorcija pumpe • [MK] Пумпа за калај • [RU] Насос олова • [SL] Črpalka za kositer • [EL] Αποκόλλησης της αντλίας • [HR] Pumpicu za odlemijvanje • [FR] pompe d'absorption d'étain • [IT] Pompa di assorbimento di stagno • [ES] Stano absorción pumpilo • [PT] Bomba de absorção de estanho



Art.No	gross weight	in cartoon	barcode
076405	0.070 kg	100 pcs	3800123159183



## HOT MELT GLUE GUN RD-GLG03

[BG] Поялник за силикон • [RO] Pistol pentru lipit cu silicon • [SR] Pištolj za lepljenje • [MK] Пиштол за топло лепење • [RU] Пистолет клеевой электрический • [SL] Pištola za lepljenje • [EL] Κόλλα όπλο • [HR] Silikonski pištolj • [FR] Pistolet à colle électrique • [IT] Pistola per colla elettrica • [ES] Elektra glumpafilo • [PT] Aplicador de cola quente

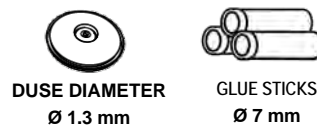

Art.No	gross weight	in cartoon	barcode
076201	0.240 kg	48 pcs	3800123162077

## HOT MELT GLUE GUN RD-GLG06

[BG] Поялник за силикон • [RO] Pistol pentru lipit cu silicon • [SR] Pištolj za lepljenje • [MK] Пиштол за топло лепење • [RU] Пистолет клеевой электрический • [SL] Pištola za lepljenje • [EL] Κόλλα όπλο • [HR] Silikonski pištolj • [FR] Pistolet à colle électrique • [IT] Pistola per colla elettrica • [ES] Elektra glumpafilo • [PT] Aplicador de cola quente

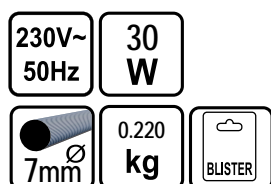

Art.No	gross weight	barcode
076204	0.240 kg	3800972012721

## HOT MELT GLUE GUN RD-GLG04

[BG] Поялник за силикон • [RO] Pistol pentru lipit cu silicon • [SR] Pištolj za lepljenje • [MK] Пиштол за топло лепење • [RU] Пистолет клеевой электрический • [SL] Pištola za lepljenje • [EL] Κόλλα όπλο • [HR] Silikonski pištolj • [FR] Pistolet à colle électrique • [IT] Pistola per colla elettrica • [ES] Elektra glumpafilo • [PT] Aplicador de cola quente

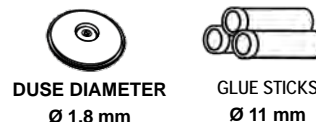
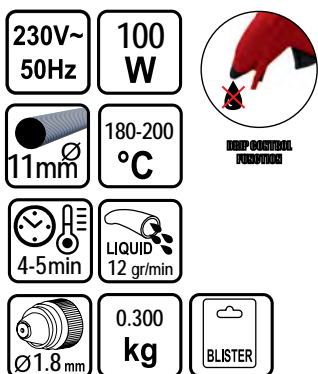

Art.No	gross weight	in cartoon	barcode
076202	0.380 kg	24 pcs	3800123162084

## HOT MELT GLUE GUN RD-GLG07

[BG] Поялник за силикон • [RO] Pistol pentru lipit cu silicon • [SR] Pištolj za lepljenje • [MK] Пиштол за топло лепење • [RU] Пистолет клеевой электрический • [SL] Pištola za lepljenje • [EL] Κόλλα όπλο • [HR] Silikonski pištolj • [FR] Pistolet à colle électrique • [IT] Pistola per colla elettrica • [ES] Elektra glumpafilo • [PT] Aplicador de cola quente

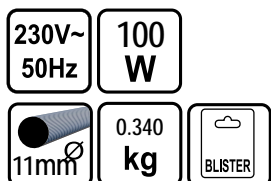

Art.No	gross weight	in cartoon	barcode
076205	0.360 kg		3800972012738



## ELECTRIC HOIST

[BG] Телфер електрически • [RO] Macara electrica • [SR] Dizalica električna • [MK] Електрична дигалка • [RU] Электрическая лебедка [SL] Električno vzvodno dvigalo • [EL] Ηλεκτρικά Βαρύλοκα • [HR] Dizalica konzolna električna • [FR] Palan électrique • [IT] Paranco elettrico • [ES] Elektra šaržilo • [PT] Guincho elétrico

**RD-EH01**
**RD-EH02**

 max LOAD with  
PULLEY

 250 kg - Art. No. 121101  
500 kg - Art. No. 121102

 max LOAD without  
PULLEY

 125 kg - Art. No. 121101  
250 kg - Art. No. 121102

**230V~  
50Hz**

art. №	W	M	Ø	max load with pulley	max load without pulley	BARCODE
121101 RD-EH01	510	6-12m	3.2mm	250kg	125kg	3800123120169
121102 RD-EH02	1020	6-12m	4.2mm	500kg	250kg	3800123120084

**RD-EH03**
**230V~  
50Hz**
**1600  
W**
**6-12 m**
**Ø5.7mm**
**1000kg  
max  
LOAD**
**500kg  
max  
LOAD**
**29  
kg**

WITH PULLEY

WITHOUT PULLEY



 max LOAD without  
PULLEY  
500 kg

 max LOAD with  
PULLEY  
1000 kg

Art.No	gross weight	barcode
121103	32.390 kg	3800123120091

**RD-EH04**
**WITH MOVING VEHICLE**
**230V~  
50Hz**
**1600  
W**
**Ø 5.7mm**
**6-12 m**
**90 mm**
**1000kg  
max  
LOAD**

WITHOUT PULLEY

WITH PULLEY

**500kg  
max  
LOAD**
**50  
kg**



 max LOAD without  
PULLEY  
500 kg

 max LOAD with  
PULLEY  
1000 kg

Art.No	gross weight	barcode
121104	55.800 kg	3800123120244

## ELECTRIC HOIST TROLLEY

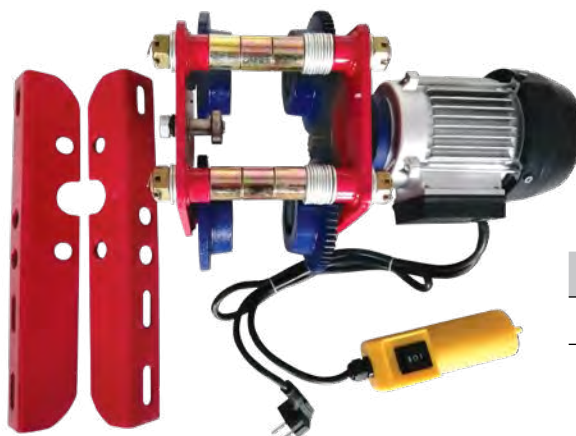
[BG] Електрическа количка за повдигане • [RO] Cărucior de ridicare electric • [SR] Električna kolica • [MK] Количка за електрична дигалка • [RU] Тележка электрическая лебедка • [SL] Električni voziček za dvigala • [EL] Ηλεκτρικό φορτίο ανύψωσης • [HR] Kolica s električnim podizanjem • [FR] Chariot élévateur électrique • [IT] Carrello paranco elettrico • [ES] Elektra širmilo • [PT] Carrinho de elevação elétrico

**NEW  
PRODUCT**

 max LOAD  
500 kg - Art. No. 079201  
1000 kg - Art. No. 079202

art. №	W	capacity	max load	BARCODE
079201 RD-EH05	60	13m/min	0.5 T	3800972016217
079202 RD-EH06	300	13m/min	1 T	3800972016224

# CHAIN BLOCK

[BG] Либедка с верига • [RO] Scipete manual • [SR] Dizalica Lančana • [MK] Дигалка со ланец • [RU] Цепной блок • [SL] Vitel Ročni z verige • [EL] Χειροκίνητο βαρούλκο με αλυσίδα • [HR] Dizalica Lančana • [FR] Bloc chaîne • [IT] Blocco a catena • [ES] Ceno bloko • [PT] Bloqueio da cadeia



max LOAD  
1000 kg - Art. No. 300401  
2000 kg - Art. No. 300402  
3000 kg - Art. No. 300403



art. №	length	max load	weight	BARCODE
300401 with one chain RD-CB01	3m	1 T	10 kg	3800123120183
300402 RD-CB02	3m	2 T	12 kg	3800123120206
300403 RD-CB03	3m	3 T	20 kg	3800123120039



# ARC WELDING MACHINE

[BG] Електрожен • [RO] Aparat de sudura • [SR] Aparat za zavarivanje • [MK] Апарат за електролачно заварување • [RU] Сварочный аппарат • [SL] Varilni aparat • [EL] Ηλεκτροσυγκολλητής • [HR] Aparat Za Varenje • [FR] Machine de soudage à l'arc • [IT] Saldatrice ad arco • [ES] Arka veldmašino • [PT] Soldadora de arco

## RD-WM17

230V~ 50Hz	48 V
40-100 A	4.8 kVA
1.6-2.5mm	11 kg



Art.No	gross weight	in cartoon	barcode
077202	12.000 kg		3800123167218

## RD-WM12

230V~ 50Hz	48 V
60-180 A	9.6 kVA
2-4mm	19 kg



Art.No	gross weight	in cartoon	barcode
129942	21.000 kg		3800123120251



**RD-WM13**

230V~ 50Hz	48 V
---------------	---------

60-200 A	11.2 kVA
-------------	-------------

2-4mm	20 kg
-------	----------



Art.No	gross weight	barcode
129943	22.000 kg	3800123120268

**INVERTER WELDING MACHINE**

[BG] Инвертор • [RO] Aparat de sudura tip inverter • [SR] Aparat za zavarivanje • [MK] Инверторот • [RU] Сварочный аппарат • [SL] Varilni aparat • [EL] Ηλεκτροσυγκολλητής • [HR] Aparat za varjenje inverter  
[FR] Poste à souder à inverseur • [IT] Saldatrice ad inverter • [ES] Inversta veldmašino • [PT] Soldadora inverter

**RD-IW160 E-LINE**

230V (400V) ~ 50Hz	65 V
--------------------------	---------

20-120 A	5.7 kVA
-------------	------------

1.6-4mm	3.7 kg
---------	-----------

**NEW  
PRODUCT**
**-economy line-**

Art.No	gross weight	barcode
077209	3.900 kg	3800972015623

**RD-IW26**

230V (400V) ~ 50Hz	65 V
--------------------------	---------

20-120 A	5.7 kVA
-------------	------------

1.6-3.2mm	2.860 kg
-----------	-------------

**NEW  
PRODUCT**

Art.No	gross weight	in carton	barcode
077210	3.740 kg	4 pcs	3800972016248

**RD-IW21**

230V (400V) ~ 50Hz	65 V
--------------------------	---------

20-120 A	6.1 kVA
-------------	------------

1.6-3.25mm	3 kg
------------	---------



Art.No	gross weight	in carton	barcode
077206	3.760 kg	4 pcs	3800972000216

# INVERTER WELDING MACHINE

[BG] Инвертор • [RO] Aparat de sudura tip inverter • [SR] Aparat za zavarivanje • [MK] Инверторот • [RU] Сварочный аппарат • [SL] Varilni aparat • [EL] Ηλεκτροσυγκολλητής • [HR] Aparat za varenje inverter  
 [FR] Poste à souder à inverseur • [IT] Saldatrice ad inverter • [ES] Inversta veldmašino • [PT] Soldadora inverter

## RD-IW180 E-LINE

**NEW  
PRODUCT**

230V~  
50Hz

65  
V

20-160  
A

4.9  
kVA

2-4mm

3.450  
kg

COLOR BOX



**-economy line-**

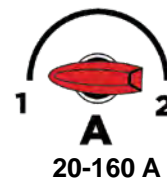

Art.No	gross weight	in cartoon	barcode
077213	5.300 kg		3800972016279

## RD-IW25

**NEW  
PRODUCT**

230V  
(400V)  
~ 50Hz

19  
V

20-160  
A

5.7  
kVA

1.6-3.2mm

4.5  
kg

COLOR BOX

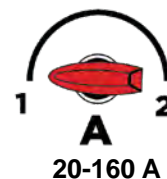

Art.No	gross weight	in cartoon	barcode
077212	5.010 kg	4 pcs	3800972016262

## RD-IW22

230V  
(400V)  
~ 50Hz

65  
V

10-160  
A

6.1  
kVA

1.5-4mm

5.5  
kg

COLOR BOX

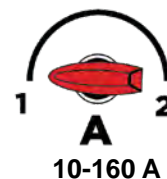

Art.No	gross weight	in cartoon	barcode
077207	6.120 kg	4 pcs	380097202265

## RD-IW19

230V  
(400V)  
~ 50Hz

65  
V

20-160  
A

6.1  
kVA

1.6 - 4.0mm

4  
kg

COLOR BOX



Art.No	gross weight	in cartoon	barcode
077204	4.500 kg	4 pcs	3800123171826



**RD-IW220 E-LINE**

**NEW  
PRODUCT**

230V~  
50Hz

65  
**V**

20-200  
**A**

5.8  
kVA

2-4mm

4.8  
**kg**

COLOR BOX



**-economy line-**



Art.No	gross weight	barcode
077214	5.500 kg	3800972016286

**RD-IW24**

**NEW  
PRODUCT**

230V  
(400V)  
- 50Hz

62  
**V**

20-200  
**A**

5.7  
kVA

1.6-4mm

5.4  
**kg**

COLOR BOX



Art.No	gross weight	in carton	barcode
077211	6.000 kg	2 pcs	3800972016255

**RD-IW20**

230V  
(400V)  
- 50Hz

62  
**V**

20-200  
**A**

7.8  
kVA

1.6-4mm

5.400  
**kg**

COLOR BOX



Art.No	gross weight	in carton	barcode
077205	6.080 kg	4 pcs	3800123171833

**RDP-IW15**



56  
**V**

10-200  
**A**

7  
kVA

Ø1.6-5mm

8.200 **kg**

COLOR BOX



**RAIDER®  
Pro**



Art.No	gross weight	in carton	barcode
123302	9.000 kg		3800123135212

## INVERTER WELDING MACHINE FOR GENERATOR RDP-IW23

[BG] Инверторен заваръчен апарат за генератор • [RO] Aparat de sudura • [SR] Aparat za zavaravanje • [MK] Инвертор • [RU] Инверторный сварочный аппарат для генератора • [SL] Inverter varilni stroj za generator • [EL] Μηχανή συγκόλλησης αντιστροφεία για γεννήτρια • [HR] Inverter aparat za zavarivanje generatora • [FR] Poste à souder à inverseur pour générateur • [IT] Saldatrice ad inverter per generatore • [ES] Kontrolni soldatšinson por generatore • [PT] Soldadora inverter

 230V~  
50Hz  
 20-200  
A

62  
V  
 7.8  
kVA

 Ø1.8-4mm

 3.700 kg

 COLOR BOX



**RAIDER®**  
Pro

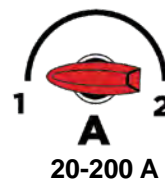

Art.No	gross weight	in cartoon	barcode
077208	4.900 kg	2 pcs	3800972004207

## MIG/MAG WELDING MACHINE RD-MW11

[BG] Теплоподаващо устройство • [RO] MIG/MAG Aparat de sudura • [SR] Aparat za zavarivanje MIG/MAG • [MK] MIG/MAG заварувачки уред • [RU] Сварочный полуавтомат • [SL] Varilni aparat mig/mag • [EL] Ηλεκτροσυγκολλησείς • [HR] Aparat za varenje sa žicom • [HR] Aparat za varenje inverter • [FR] Machine à souder Mig / Mag • [IT] Dispositivo semiautomatico di saldatura automatica • [ES] Automata veldado kun duobla aparato • [PT] Dispositivo automático de soldagem semiautomática

230V~  
50Hz  
 35  
V  
 6.2  
kVA  
 30-135  
A  
 0.6-1mm  
 26.000  
kg  
 COLOR BOX

WELDING TORCH (INCLUDED)

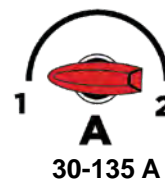

Art.No	gross weight	in cartoon	barcode
129961	26.500 kg		3800123152146





# WELDING HELMET AUTO-DARKENING

[BG] Шлем заваръчен фотосоларен • [RO] Masca de sudura • [SR] Maska za zavarivanje automatik • [MK] Самозатемнувачка кацига за заварување • [RU] Сварочный шлем • [SL] Avtomatska čelada za varjenje [EL] Κίνα Αυτόματη συγκόλλησης κρόνος • [HR] Maska za Zavarivanje fotosjetljiva automatska solarna • [FR] Casque de soudage • [IT] Casco per saldatura • [ES] Solda kasko • [PT] Capacete de soldar c/ escurecimento automático

## RD-WHO1

2PCS  
PROTECTIVE LENS  
FREE OF CHARGE

*DIN 8/10/12*



- Optical class: 1/1/1/2
- Filter dimension: 110×90×9mm
- View size: 92×42mm
- Light state shade: DIN 4
- Dark state shade: DIN8/10/12, can be selected
- Switching time from Light to Dark: 1/25000 sec
- Sensitivity control: Low or high can be selected
- Delay time from Dark to Light: 0.2-0.5 sec.
- Arc sensors: 1

- TIG range: ≥ 35 amps/DC; ≥ 15 amps/AC
- UV/IR protection: Up to DIN 16 At all time
- Powered supply: Solar Cells + Sealed Lithium battery
- Power on/off: Full automatic
- Operate temp: -10°C + 55°C
- Storing temp: -20°C + 70°C
- Material: PP
- Approval: CE EN175 EN379
- N.W.: 445g



**SOLAR CELLS**

Art.No	gross weight	in cartoon	barcode
138301	0.270 kg	6 pcs	3800123174278

## RD-WHO2

2PCS  
PROTECTIVE LENS  
FREE OF CHARGE

*DIN 9-13*



- Optical class: 1/1/1/2
- Filter dimension: 110×90×9mm
- View size: 92×42mm
- Light state shade: DIN 4
- Dark state shade: DIN 9-13, Stepless adjusted
- Switching time from Light to Dark: 1/25000sec
- Sensitivity control: Adjustable from Low to high
- Delay time from Dark to Light: Adjustable from 0.2 sec. (fast) to 1.0 sec. (slow)
- Arc sensors: 2

- TIG range: ≥ 35 amps/DC; ≥ 15 amps/AC
- GRINDING function: Yes
- UV/IR protection: Up to DIN 16 At all time
- Powered supply: Solar Cells + Sealed Lithium battery
- Power on/off: Full automatic
- Operate temp: -10°C + 55°C
- Storing temp: -20°C + 70°C
- Material: PP
- Approval: CE EN175 EN379
- N.W.: 465g



**SOLAR CELLS**

Art.No	gross weight	in cartoon	barcode
138302	0.270 kg	6 pcs	3800123174285

## RD-WHO3

**BG DESIGN**

*DIN 9-13*



- Optical class: 1/1/1/2
- Filter dimension: 110×90×9mm
- View size: 92×42mm
- Light state shade: DIN 4
- Dark state shade: DIN 9-13, Stepless adjusted
- Switching time from Light to Daark: 1/25000sec
- Sensitivity control: Adjustable from Low to high
- Delay time from Dark to Light: Adjustable from 0.2 sec. (fast) to 1.0 sec. (slow)
- Arc sensors: 2

- TIG range: ≥ 35 amps/DC; ≥ 15 amps/AC
- GRINDING function: Yes
- UV/IR protection: Up to DIN 16 At all time
- Powered supply: Solar Cells + Sealed Lithium battery
- Power on/off: Full automatic
- Operate temp: -10°C + 55°C
- Storing temp: -20°C + 70°C
- Material: PP
- Approval: CE EN175 EN379
- N.W.: 465g



**SOLAR CELLS**

Art.No	gross weight	in cartoon	barcode
138307	0.270 kg	6 pcs	3800972004405

## RD-WHO4

**RO DESIGN**

*DIN 9-13*



- Optical class: 1/1/1/2
- Filter dimension: 110×90×9mm
- View size: 92×42mm
- Light state shade: DIN 4
- Dark state shade: DIN 9-13, Stepless adjusted
- Switching time from Light to Dark: 1/25000sec
- Sensitivity control: Adjustable from Low to high
- Delay time from Dark to Light: Adjustable from 0.2 sec. (fast) to 1.0 sec. (slow)
- Arc sensors: 2

- TIG range: ≥ 35 amps/DC; ≥ 15 amps/AC
- GRINDING function: Yes
- UV/IR protection: Up to DIN 16 At all time
- Powered supply: Solar Cells + Sealed Lithium battery
- Power on/off: Full automatic
- Operate temp: -10°C + 55°C
- Storing temp: -20°C + 70°C
- Material: PP
- Approval: CE EN175 EN379
- N.W.: 465g



**SOLAR CELLS**

Art.No	gross weight	in cartoon	barcode
138309	0.270 kg	6 pcs	3800972010260

## WELDING FILTER WITH SOLAR CELLS FOR WELDING HELMET

[BG] Филтър за заваръчен шлем RAIDER • [RO] Filtru pentru masca de sudura • [SR] Filter za maska za zavarivanje automatik • [MK] Филтер за самозатемнувачка кацига за заварување • [RU] Фильтр для сварочный шлем • [SL] Filter za avtomatska čelada za varjenje • [EL] Φίλτρο ΚίναΑυτόματη συγκόλλησης κράνος • [HR] Filter za kaciga za zavarivanje • [FR] Filtre de soudage avec cellules solaires • [IT] Filtrò per saldatura con celle solari per casco di saldatura • [ES] Soldada Filtrilo Kun Sunaj Čeloj Por Soldado-Kasko • [PT] Filtro de soldagem com células solares para capacete de soldagem

DIN 9-13

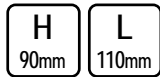
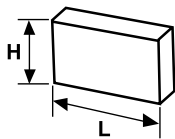

Art.No	gross weight	in cartoon	barcode
138305	0.130 kg	50 pcs	3800123174315

## FRONT PROTECTIVE LENS FOR WELDING HELMET 5 PCS.

[BG] Екран външен предпазен за шлем RAIDER • [RO] Lentila frontala de protectie pentru masca de sudura • [SR] Prednje zaštitno staklo za maska za zavarivanje automatik • [MK] Предно заштитно стакло за самозатемнувачка кацига за заварување • [RU] Передний защитное стекло для сварочный шлем • [SL] Sprednja zaščitna stekla za avtomatska čelada za varjenje • [EL] Εμπρός προστατευτικό υαλί ΚίναΑυτόματη συγκόλλησης κράνος • [HR] Prednja zaštitna stakla za kaciga za zavarivanje • [FR] Lentille de protection avant pour casque de soudeur • [IT] Lente protettiva frontale per casco di saldatura • [ES] Antaüa protekta lenso por veldi kaskon • [PT] Lente de proteção frontal para capacete de soldagem

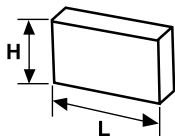

art. №	L	H	barcode
138303 for RD-WH01	113	89	3800123174292
138306 for RD-WH02	3m	2 T	3800123174322

## INSIDE PROTECTIVE LENS FOR WELDING HELMET 5 PCS.

[BG] Екран вътрешен предпазен за шлем RAIDER • [RO] Lentila interna de protectie pentru masca de sudura • [SR] Interni zaštitno staklo za maska za zavarivanje automatik • [MK] Внатрешно заштитно стакло за самозатемнувачка кацига за заварување • [RU] Внутреннее защитное стекло для сварочный шлем • [SL] Notranji zaščitna stekla za avtomatska čelada za varjenje • [EL] Εσωτερικός προστατευτικό υαλί ΚίναΑυτόματη συγκόλλησης κράνος • [HR] Interno zaštitno staklo za kaciga za zavarivanje • [FR] Lentille de protection intérieure pour casque de soudage • [IT] Lente protettiva interna per casco per saldatura • [ES] Ene de protekta lenso Por Soldado-Kasko • [PT] Lente protetora interna para capacete de soldagem

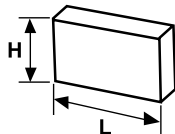

Art.No	gross weight	in cartoon	barcode
138304	0.010 kg	400 pcs	3800123174308

## INVERTER BATTERY CHARGER RD-BC13

[BG] Зарядно за акумулатор инверторно • [RO] Redresor auto digital • [SR] Punjač akumulatora • [MK] Полнач за акумулатор • [RU] Зарядное устройство инвертор для аккумуляторов • [SL] Polnilec baterij • [EL] Φορτιστής μπαταριών • [HR] Inverter baterijski punjač • [FR] Chargeur de batterie inverter • [IT] Carica batterie inverter • [ES] Insura batteria kargero • [PT] Carregador de bateria do inversor



- Battery charge level indicator
  - Charges automobile batteries up to 120 Ah
  - Automatically switches off when the full battery charge is reached
  - 8 programs
  - Can be used to support boat accumulators, jets, etc. machines that are not used in the winter
  - Charges both classic lead acid batteries and the latest WET MF, GEL, AGM, Ca-Ca batteries. This charger can also revive a very exhausted battery.
- The following protections are built in:
1. overload protection;
  2. protection against polarity reversal;
  3. short-circuit protection of the terminals;
- Degree of protection IP 65 for outdoor use

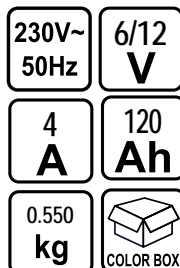

Art.No	gross weight	in cartoon	barcode
032202	0.700 kg	4 pcs	3800972002951



# BATTERY CHARGER

[BG] Зарядно за акумулатор • [RO] Incarcator acumulator • [SR] Punjač akumulatora • [MK] Полнач за акумулатор • [RU] Зарядное устройство для аккумуляторов • [SL] Polnilca Za Baterije • [EL] Φορτιστής Μπαταριών • [HR] Punjač Akumulatora • [FR] Chargeur de batterie • [IT] Caricabatterie • [ES] Sargilo • [PT] Carregador de bateria

## RD-BC05

230V~ 50Hz	6/12 <b>V</b>
75 <b>W</b>	5 <b>A</b>
20-75 <b>Ah</b>	3.340 <b>kg</b>

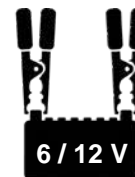
Art.No	gross weight	in cartoon	barcode
032201	3.700 kg	4 pcs	3800123162299

## RD-BC10

230V~ 50Hz	12 <b>V</b>
85 <b>W</b>	5 <b>A</b>
20-60 <b>Ah</b>	3.600 <b>kg</b>

Art.No	gross weight	in cartoon	barcode
129962	4.120 kg	4 pcs	3800123152153

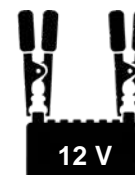
## RD-BC11

230V~ 50Hz	12/24 <b>V</b>
110 <b>W</b>	9 <b>A</b>
25-135 <b>Ah</b>	4.165 <b>kg</b>



Art.No	gross weight	in cartoon	barcode
129963	4.700 kg	4 pcs	3800123152160

## RD-BC12

230V~ 50Hz	12/24 <b>V</b>
310 <b>W</b>	14 <b>A</b>
92-210 <b>Ah</b>	7.740 <b>kg</b>





Art.No	gross weight	in cartoon	barcode
129964	8.620 kg	4 pcs	3800123152177

## GASOLINE GENERATOR RD-GG08

[BG] Генератор за ток бензинов двутактов • [RO] Generator benzina • [SR] Benzinski generator • [MK] Генератор на струја • [RU] Мощность генератора • [SL] Generator moči • [EL] Ισχύ γεννήτριας • [HR] Dizalica konzolna električna • [FR] Générateur d'essence deux temps • [IT] Generatore di benzina a due tempi • [ES] Benzina generador du batoj • [PT] Gerador a gasolina dois cursos

Бенз. двигател: Едноцилиндров, двутактов с въздушно охлаждане.  
Gasoline engine: One cylinder, 2 stroke with air cooling.

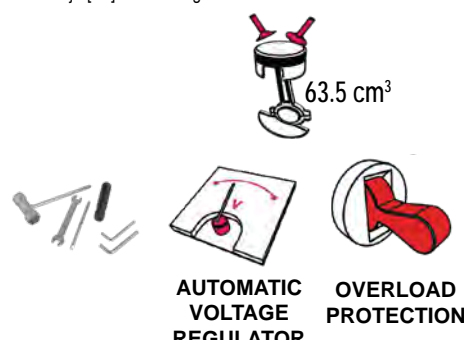
	3000 min <sup>-1</sup>	12V DC
	650 W	



Art.No	gross weight	in cartoon	barcode
090106	17.000 kg	1 pcs	3800972010659

## GASOLINE GENERATOR INVERTOR

[BG] Генератор за ток бензинов инверторен • [RO] Generator benzina invertor • [SR] Benzinski generator invertor • [MK] Генератор на струја инвертер • [RU] Генератор мощность инвертор • [SL] Generator moči invertor • [EL] Ισχύ γεννήτριας αντιστροφείας • [HR] Dizalica konzolna električnainvertor • [FR] Générateur à essence inverseur • [IT] Inverter del generatore di benzina • [ES] Generador de benzino • [PT] Inversor gerador a gasolina

Бенз. двигател: Едноцилиндров, четиритактов с въздушно охлаждане.  
Gasoline engine: One cylinder, 4 stroke with air cooling.

	5500 min <sup>-1</sup>	12V DC
	1000 W	



Art.No	gross weight	in cartoon	barcode
090102	16.000 kg	1 pcs	3800972000476

## RD-GG10

Бенз. двигател: Едноцилиндров, четиритактов с въздушно охлаждане.  
Gasoline engine: One cylinder, 4 stroke with air cooling.

	5300 min <sup>-1</sup>	
	2500 W	

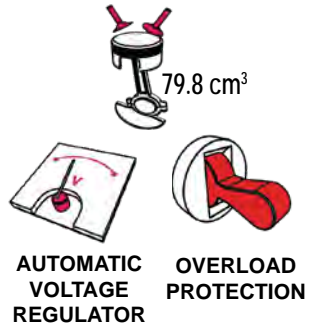

Art.No	gross weight	in cartoon	barcode
090105	25.000 kg	1 pcs	3800972010666

## GASOLINE GENERATOR

[BG] Генератор за ток бензинов • [RO] Generator benzina • [SR] Benzinski generator • [MK] Генератор на струја • [RU] Мощность генератора • [SL] Generator moči • [EL] Ισχύ γεννήτριας • [HR] Dizalica konzolna električna • [FR] Générateur d'essence • [IT] Generatore di benzina • [ES] Benzina generador • [PT] Gerador a gasolina

Бенз. Двигател: Едноцилиндров, четиритактов с въздушно охлаждане.  
Gasoline Engine: One cylinder, 4 stroke with air cooling.

	3600 min <sup>-1</sup>	12V DC
	2000 W	

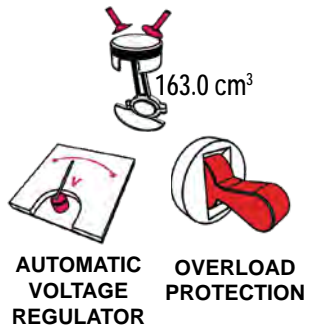

Art.No	gross weight	in cartoon	barcode
129931	39.000 kg	1 pcs	3800123145056



**RD-GG06**

Бенз. Двигател: Едноцилиндров, четиритактов с въздушно охлаждане.  
Gasoline Engine: One cylinder, 4 stroke with air cooling.

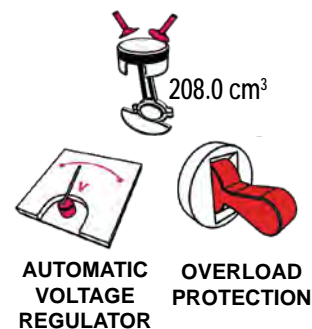
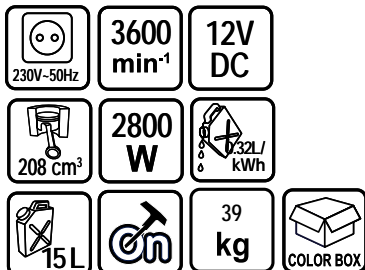

Art.No	gross weight	in cartoon	barcode
090103	44.000 kg	1 pcs	3800972000483

**RD-GG04**

Бенз. Двигател: Едноцилиндров, четиритактов с въздушно охлаждане.  
Gasoline Engine: One cylinder, 4 stroke with air cooling.

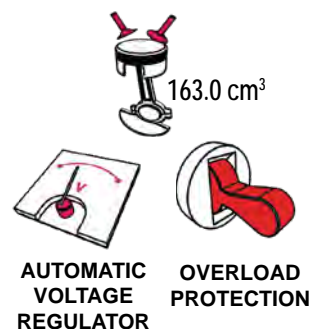
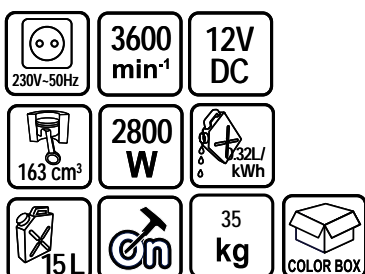

Art.No	gross weight	in cartoon	barcode
090101	38	1 pcs	3800123169830

**RD-GG03**

Бенз. Двигател: Едноцилиндров, четиритактов с въздушно охлаждане.  
Gasoline Engine: One cylinder, 4 stroke with air cooling.

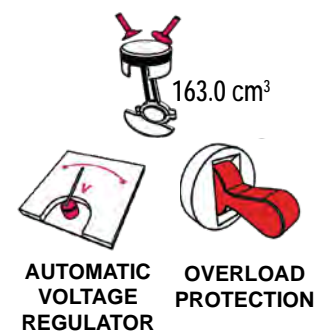

Art.No	gross weight	in cartoon	barcode
129941	83.000 kg	1 pcs	3800123120213

## RD-GG07

Бенз. Двигател: Едноцилиндров, четиритактов с въздушно охлаждане.  
Gasoline Engine: One cylinder, 4 stroke with air cooling.

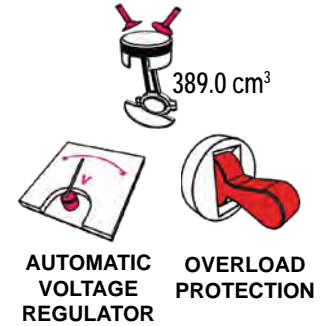
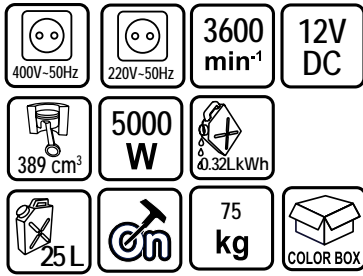

Art.No	gross weight	in cartoon	barcode
090104	84.000 kg		3800972000490



## ELECTRIC WINCH

[BG] Автoлeбeдкa • [RO] Troliu electric • [SR] Električno vitlo • [MK] Елeктричнo витлo • [RU] Элeктричeскaя лeбeдкa грузoвик • [SL] Električni vitel • [EL] Αὐτoμάτῃς ἠλεκτρίκa βαρoύλoκo • [HR] Električna dizalica • [HR] Dizalica konzolna električna • [FR] Treuil électrique • [IT] Verricello elettrico • [ES] Elektra turbo • [PT] Guincho elétrico

### RD-EW05

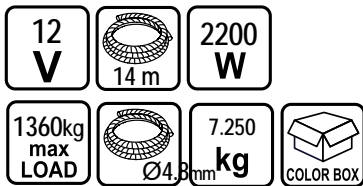

**max LOAD**  
1360 kg

Art.No	gross weight	in cartoon	barcode
121605	9.430 kg		3800123120077

### RD-EW06

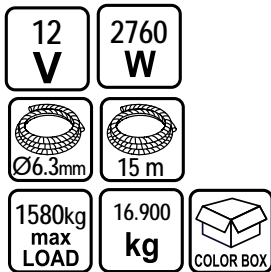

**max LOAD**  
1580 kg

Art.No	gross weight	in cartoon	barcode
121606	18.560 kg		3800123120114

### RD-EW07

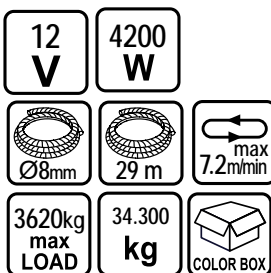

**max LOAD**  
3620 kg

Art.No	gross weight	in cartoon	barcode
121608	35.800 kg		3800123119934



## HYDRAULIC BOTTLE JACK

[BG] Крик хидравличен тип "бутилка" • [RO] Cric hidraulic • [SR] Hidrauličnu dizalicu tip "flaša" • [MK] Хидраулична дигалка • [RU] Гидравлическая бутылка • [SL] Hidravlična dvigalka • [EL] Γρύλος αυτοκινήτου • [HR] Hidraulična dizalica • [FR] Bouteille hydraulique • [IT] Presa per bottiglia idraulica • [ES] Hidraülিকা botela fanto • [PT] Macaco hidraulico

Art. №	Model	Load (tone)	WEIGHT KG	min H mm	max H mm	max H mm	max H mm	Barcode
300101	RD-HB02	2	2.2	148	278	80	50	3800123136016
300102	RD-HB03	3	3	180	340	110	50	3800123136023
300103	RD-HB04	4	3	180	340	110	50	3800123136030
300104	RD-HB05	5	4	185	355	110	60	3800123136047
300106	RD-HB10	10	5.4	200	385	125	60	3800123136061
300108	RD-HB15	15	7.5	255	425	140	60	3800123136085
300109	RD-HB20	20	9.9	235	440	145	60	3800123136092
300110	RD-HB32	32	13	255	405	150		3800123136108
300111	RD-HB50	50	21	255	405	150		3800123136115



## HYDRAULIC BOTTLE JACK RD-HB20L

[BG] Крик хидравличен нископрофилен тип "бутилка" • [RO] Cric hidraulic • [SR] Hidrauličnu dizalicu tip "flaša" • [MK] Хидраулична дигалка • [RU] Гидравлическая бутылка • [SL] Hidravlična dvigalka • [EL] Γρύλος αυτοκινήτου • [HR] Hidraulična dizalica • [FR] Cric bouteille hydraulique profil bas • [IT] Tappo idraulico della bottiglia a basso profilo • [ES] Hidraülিকা sako butono malalta profilo • [PT] Macaco hidraulico

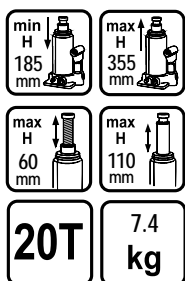

Art.No	gross weight	in cartoon	barcode
300112	7.680 kg	2 pcs	3800123173974

## TROLLEY JACK

[BG] Крик хидравличен тип "Крокодил" • [RO] Cric crocodil • [SR] Dizalica hidraulična krokodilka • [MK] Хидраулична крокодил дигалка • [RU] Гидравлический автомобильный домкрат • [SL] Hidravlična dvigalka na kolesih • [EL] Γρύλος Τρέιλερ αυτοκινήτου • [HR] Hidraulična dizalica • [FR] Vérin hydraulique • [IT] Presa auto idraulica • [ES] Hidraülিকা automóvil • [PT] Tomada do carro hidráulico



Art. №	Model	Load (tone)	WEIGHT KG	min H mm	max H mm	Barcode
300201	RD-TJ01	2	6.3	130	300	3800123136139
300207 in case	RD-TJ01	2	6.3	130	300	3800123136504
300202	RD-TJ02	2	11.2	125	390	3800123136146
300209	RD-TJ06	2	12.6	85	380	3800123136398
300205	RD-TJ04	3	18.1	138	420	3800123136245
300204	RD-TJ03	3	34	120	495	3800123136153
300208	RD-TJ05	3	29	135	500	38001231363845

## FARM JACK RD-FJ01

[BG] Крик високоповдигащ • [RO] Cric H-Lift • [SR] Dizalica velika stupa • [MK] Дигалка H-Lift • [RU] Домкрат реечный автомобильный • [SL] Dvigalo Ročno • [EL] Γρύλος αυτοκινήτου • [HR] Hi-lift dizalica • [FR] La prise est rack voiture • [IT] Il jack è rack automobilistico • [ES] La kato estas rako auto • [PT] O jack é rack de automóvel

MAX. HEIGHT 48" / 120 cm



Art.No	gross weight	in cartoon	barcode
309904	12.650 kg		3800123173776

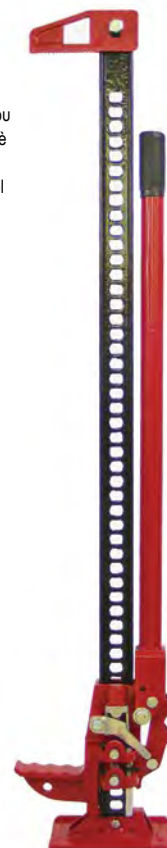

## SCISSOR JACK

[BG] Крик винтов тип "жаба" • [RO] Cric foarfeca • [SR] Dizalica sa navojem • [MK] Рачна Дигалка • [RU] Ножничный подъемник • [SL] škarjasto Dvigalo • [EL] Γούλος Μηχανικός • [HR] Trapez dizalica • [FR] La prise est rack voiture • [IT] Il jack è rack automobilistico • [ES] La kato estas rako auto • [PT] O jack é rack de automóvel



Art.No	gross weight	in cartoon	barcode
309903	2.080 kg	10 pcs	3800123154942

## AXLE STANDS PAIR 2 PCS SET

[BG] Стойки за автомобил с гребен • [RO] Set 2 buc. cric hidraulic • [SR] Držač par • [MK] Држач • [RU] Стенды за автомобиль с гребнем • [SL] Stojalo za avto par • [EL] Βάσεις αυτοκινήτο • [HR] Podupirači • [FR] La prise est rack voiture • [IT] Il jack è rack automobilistico • [ES] La kato estas rako auto • [PT] O jack é rack de automóvel



Art.No	gross weight	in cartoon	barcode
300702	5.330 kg	6 pcs	3800123136214

## HYDRAULIC BODY REPAIR KIT RD-PHE03

[BG] Разпъвачка хидравлична за автомобили • [RO] Echipament hidraulic • [SR] Autolimarska oprema za razvlačenje • [MK] Хидраулични комплет за исправанье • [RU] Комплект гидравлический для рихтовки кузова • [SL] Komplet za popravilo udrtinna osnovi hidravlike • [EL] Σετ επισκευων υδραυλικων υστισκευων [HR] Autolimarska oprema za razvlačenje • [FR] Kit hydraulique pour le soutien du corps • [IT] Kit idraulico per la pastura del corpo • [ES] Hidraulica kit por korpoj • [PT] Kit esticador hidraulico

CAPACITY (TON)	STROKE (mm)	MIN. HEIGHT (mm)	MAX. HEIGHT (mm)
4	18	42	58
10	57	132	189
2	70	139	240
4	125	275	405
10	150	350	500
5	130	520	650



METAL CASE

Art.No	gross weight	barcode
300612	23.600 kg	3800123173783

## HYDRAULIC BODY REPAIR KIT

[BG] Разпъвачка хидравлична за автомобили • [RO] Echipament hidraulic • [SR] Autolimarska oprema za razvlačenje • [MK] Хидраулични комплет за исправанье • [RU] Комплект гидравлический для рихтовки кузова • [SL] Komplet za popravilo udrtinna osnovi hidravlike • [EL] Σετ επισκευων υδραυλικων υστισκευων [HR] Autolimarska oprema za razvlačenje • [FR] Kit hydraulique pour le soutien du corps • [IT] Kit idraulico per la pastura del corpo • [ES] Hidraulica kit por korpoj • [PT] Kit esticador hidraulico

### RD-PHE04

CAPACITY (TON)	STROKE (mm)	MIN. HEIGHT (mm)	MAX. HEIGHT (mm)
10T			
4	18	42	58
10	57	132	189
2	70	139	240
4	120	275	395
10	135	325	460
5	155	345	500
20	145	325	470
15		250	420



Art.No	gross weight	barcode
300613	39.000 kg	3800972005679



**RD-PHE05**
**4T**
**17 kg**

CAPACITY (TON)	STROKE (mm)	MIN. HEIGHT (mm)	MAX. HEIGHT (mm)
4	18	42	58
10	57	132	189
2	70	139	240
4	120	275	395
10	135	325	460
5	155	345	500
20	145	325	470
15		250	420

Art.No	gross weight	in cartoon	barcode
300614	18.000 kg	1	3800972005686

**RD-PHE06**
**15T**
**43 kg**

CAPACITY (TON)	STROKE (mm)	MIN. HEIGHT (mm)	MAX. HEIGHT (mm)
4	18	42	58
10	57	132	189
2	70	139	240
4	120	275	395
10	135	325	460
5	155	345	500
20	145	325	470
15		250	420

Art.No	gross weight	in cartoon	barcode
300615	33.000 kg	1	3800972005693

**RD-PHE07**
**20T**
**57 kg**

CAPACITY (TON)	STROKE (mm)	MIN. HEIGHT (mm)	MAX. HEIGHT (mm)
4	18	42	58
10	57	132	189
2	70	139	240
4	120	275	395
10	135	325	460
5	155	345	500
20	145	325	470
15		250	420

Art.No	gross weight	in cartoon	barcode
300616	58.000 kg	1	3800972005709

**2 METAL CASES**

## HYDRAULIC BENCH PRESS WITH PRESSURE GAUGE

[BG] Преса хидравлична настолна с манометър • [RO] Presa hidraulica • [SR] Hidraulična presa • [MK] Хидраулична преса  
 • [RU] Пресс гидравлический настольный • [SL] Hidravlične stiskalnice • [EL] υδραυλική πρέσα • [HR] Ručna hidraulična  
 preša • [FR] Presse de banc hydraulique avec manomètre • [IT] Banco da banco idraulico con manometro • [ES] Hidraúlika  
 benka gazetaro kun premometro • [PT] Prensa hidráulica

**RD-HP02**
**10T**
**50 kg**

Art.No	gross weight	in cartoon	barcode
300604	50.700 kg	1	3800123173691



## HYDRAULIC FLOOR PRESS RD-HP1

[BG] Преса хидравлична настолна • [RO] Presa hidraulica • [SR] Hidraulična presa • [MK] Хидраулична преса • [RU] Пресс гидравлический настольный • [SL] Hidravlične stiskalnice • [EL] Υδραυλική πρέσα • [HR] Ručna hidraulična preša • [FR] Presse de banc hydraulique [IT] Banco da banco idraulico • [ES] Hidráulica benka • [PT] Prensa hidráulica

12T  
42 kg



Art.No	gross weight	barcode
300603	42.500 kg	3800123128417

## RD-HP03

12T  
66 kg



Art.No	gross weight	barcode
300605	66.800 kg	3800123173707

## RD-HP04

20T  
86 kg



Art.No	gross weight	barcode
300606	86.800 kg	3800123173714

## PNEUMATIC PRESS WITH PRESSURE GAUGE RD-HP05

[BG] Преса хидравлична с манометър и пневматично управление • [RO] Presa pneumatica cu manometru • [SR] Pnevmatiska presa • [MK] Пневматски преса • [RU] Пресс пневматический настольный [SL] Pnevmatiska stiskalnice • [EL] Πνευματικός πρέσα • [HR] Ručna pnevmatska preša • [FR] Presse pneumatique de table • [IT] Pressa pneumatica da tavolo • [ES] Tabla pneumática gazetarro • [PT] Prensa hidráulica

20T  
86.5 kg



Art.No	gross weight	barcode
300607	88.000 kg	3800123173721

## SINGLE CYLINDER TRANSMISSION JACK RD-TRJ01

[BG] Крик за скоростни кутии • [RO] Cric hidraulic pentru cutii de viteze • [SR] Dizalica za menjač • [MK] Дигалка за менџач • [RU] Домкрат трансмиссионные • [SL] Dvigalka za menjalnik • [EL] Γρούλος κιβώτιο ταχυτήτων • [HR] Dizalica za mjenjač • [FR] Cric de transmission monocylindre • [IT] Jack di trasmissione a singolo cilindro • [ES] Transdono jack • [PT] Jack de transmissão

min H 1000 mm  
max H 1900 mm  
0.5T  
29.00 kg



Art.No	gross weight	barcode
300608	29.000 kg	3800123173738

## ENGINE STAND RD-EST01

[BG] Стойка за двигатели • [RO] Suport pentru motor • [SR] Nosač motora • [MK] Држач за мотор • [RU] Стенд для двигателя • [SL] Stojalo za motor • [EL] Σταντ Κινητήρα • [HR] Nosac motora • [FR] Stand pour les moteurs • [IT] Supporto per motori • [ES] Stari por motoroj • [PT] Suporte para motores

567kg max LOAD  
27.00 kg



Art.No	gross weight	barcode
300609	27.000 kg	3800123173745

## HYDRAULIC PIPE BLENDER RD-HPB01

[BG] Тръбогиб хидравличен • [RO] Dispozitiv hidraulic pentru indoiti tevi • [SR] Savijač cevi hidraulični • [MK] Хидраулични Цевки Бендер • [RU] Трубогиб гидравлический • [SL] Navpični hidravlični stroj za krivljenje cevi • [EL] Υδραυλικός Κουρμπαδόρος Σωλήνων • [HR] Savijač cijevi hidraulički • [FR] Cintreuse hydraulique • [IT] Curvatubi idraulico • [ES] Hidráulica tubaro • [PT] Dobrador de tubo hidraulico

1/2" + 3/4" + 1" + 1 1/4" + 1 1/2" + 2"

12T  
min H 320 mm  
max H 570 mm  
1/2" - 2"  
31.200 kg



Art.No	gross weight	barcode
300610	31.700 kg	3800123173752





### HYDRAULIC GEAR PULLER 3 JAW RD-HGP01

[BG] Скоба за лагери трираменна хидравлична • [RO] Extractor hidraulic cutie de viteze • [SR] Hidraulični radapciger • [MK] Хидраулични извлекувач со 3 рамена • [RU] Гидравлические съемник подшипников • [SL] Hidravlični snemalec 3 kos • [EL] Υδραυλικό σεί Εξολκέας • [HR] Hidraulični radapciger • [FR] Presse pneumatique de table • [IT] Pressa pneumatica da tavolo • [ES] Tabla pneumática gazetaro • [PT] Saca-rolamentos hidraulico

**5T**

max H  
200  
mm



max LOAD  
5000 kg

Art.No	gross weight	in cartoon	barcode
300611	5.880 kg	2 pcs	3800123173769

### HYDRAULIC ENGINE HOIST RD-HEHO1

[BG] Кран за повдигане на двигатели • [RO] Macara Hidraulica tip "Girafa" • [SR] Dizalica za podizanje motora • [MK] Кран за дигање на мотори • [RU] Кран гидравлический • [SL] Dvigalo motorjev • [EL] Υδραυλικός γερανός κινητήρων • [HR] Radionički Kran • [FR] Palan à moteur hydraulique • [IT] Paranco motore idraulico • [ES] Levilo de hidráulica motoro • [PT] Talha hidráulica do motor

**1T**

**67  
kg**

COLOR BOX



max LOAD  
1000 kg

Art.No	gross weight	barcode
309901	66.800 kg	3800123136221

### HYDRAULIC CYLINDER FOR HYDRAULIC ENGINE HOIST

[BG] Силов цилиндър за кран за повдигане на двигатели • [RO] Cilindu hidraulic pentru ridicarea motorului • [SR] Hidraulični cilindar za podizanje hidrauličnih motora • [MK] Хидрауличен цилиндер за дигалка на хидрауличен мотор • [RU] Гидравлический цилиндр для подъема двигателя • [SL] Hidravlični cilindar za dvigalo hidravličnega motorja • [EL] Υδραυλικός κύλινδρος για υδραυλικό ανυψωτικό κινητήρα • [HR] Hidraulički cilindar za dizalicu motora • [FR] Vérin hydraulique pour palan moteur • [IT] Cilindro idraulico per paranco motore • [ES] Hidráulica cilindro por levado de motoro • [PT] Cilindro hidráulico para talha do motor

**NEW  
PRODUCT**



max LOAD  
1000 kg - Art. No. 309905  
2000 kg - Art. No. 309906

Art.No	Capacity	gross weight	barcode
309905	1T	14.000 kg	3800972003071
309906	2T	10.000 kg	3800972003088



## ELECTRIC CHAIN SAW

[BG] Резачка електрическа • [RO] Fierastrau electric cu lant • [SR] Električna motorna testera • [MK] Електрична пила • [RU] Электрические цепные пилы • [SL] Električna žaga • [EL] Ηλεκτρικό αλυσοπρίονο • [HR] Električna lančana pila • [FR] Scie à chaîne électrique • [IT] Sega a catena elettrica • [ES] Elektra segilo • [PT] Moto-serra elétrica

RD-ECS21

**NEW  
PRODUCT**

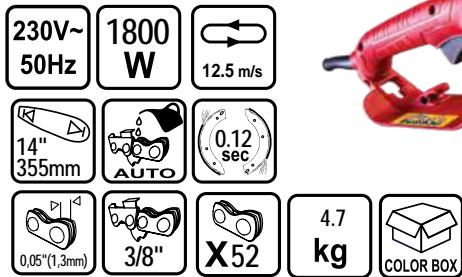

Art.No	gross weight	in cartoon	barcode
075115	5.480 kg	2 pcs	3800972015418

RD-ECS22

**NEW  
PRODUCT**

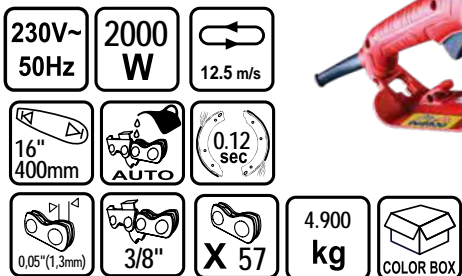

Art.No	gross weight	in cartoon	barcode
075116	5.600 kg	2 pcs	3800972015425



**RD-ECS16X**

230V~  
50Hz    2000  
W    12.5 m/s

14"  
355mm    AUTO    0.12  
sec

0,05"(1,3mm)    3/8"    X 52

4.540  
kg    COLOR BOX

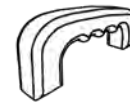

**ERGONOMIC HANDLE**

Art.No	gross weight	in cartoon	barcode
075110	4.990 kg	2 pcs	3800972002272

**RD-ECS23**

**NEW PRODUCT**

230V~  
50Hz    2000  
W    12.5 m/s

16"  
400mm    AUTO    0.12  
sec    FAST LOCK

0,05"(1,3mm)    3/8"    X 57

4.800  
kg    COLOR BOX



**ERGONOMIC HANDLE**

Art.No	gross weight	in cartoon	barcode
075117	5.270 kg	2 pcs	3800972015432

**RD-ECS17X**

**NEW PRODUCT**

230V~  
50Hz    2000  
W    12.5 m/s

16"  
400mm    AUTO    0.12  
sec    FAST LOCK

0,05"(1,3mm)    3/8"    X 57

4.920  
kg    COLOR BOX



**OREGON GUIDE BAR AND CHAIN**

Art.No	gross weight	in cartoon	barcode
075111	5.270 kg	2 pcs	3800972002289

**RD-ECS18X**

230V~  
50Hz    2200  
W    12.5 m/s

16"  
400mm    AUTO    0.12  
sec    FAST LOCK

0,05"(1,3mm)    3/8"    X 57

5.420  
kg    COLOR BOX



**OREGON GUIDE BAR AND CHAIN**

Art.No	gross weight	in cartoon	barcode
075112	5.750 kg	2 pcs	3800972002296

## RD-ECS24

**NEW  
PRODUCT**

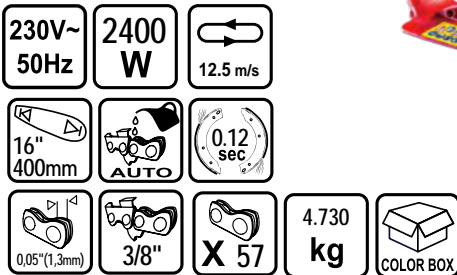

**OREGON GUIDE  
BAR AND CHAIN**

Art.No	gross weight	in cartoon	barcode
075118	6.250 kg	2 pcs	3800972015449

## RD-ECS20X

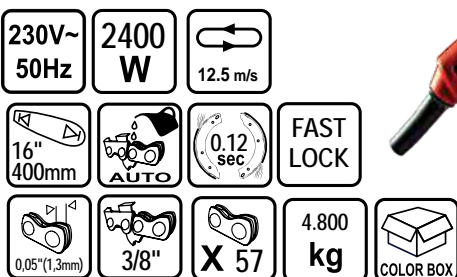

**OREGON GUIDE  
BAR AND CHAIN**

Art.No	gross weight	in cartoon	barcode
075114	5.750 kg	2 pcs	3800972014299

## RD-ECS19

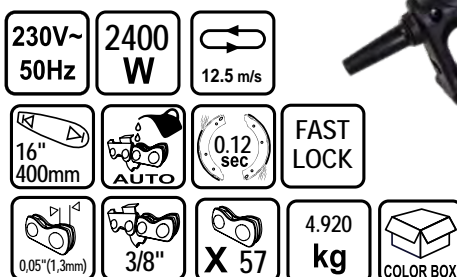

**OREGON GUIDE  
BAR AND CHAIN**

Art.No	gross weight	in cartoon	barcode
075113	6.080 kg	2 pcs	3800972003545

## RD-ECS25

**NEW  
PRODUCT**



Art.No	gross weight	in cartoon	barcode
075119	6.300 kg	2 pcs	3800972015456



# GASOLINE CHAIN SAW

[BG] Ресачка бензинова • [RO] Motofierastrau benzina cu lant • [SR] Benzinska lancana testera • [MK] Моторна пила • [RU] Цепная пила gasoline • [SL] Motornih žag • [EL] Βενζινοκίνητο Αλυσοπρίονο • [HR] Motorna pila • [FR] Scie à chaîne essence • [IT] Motosega a benzina • [ES] Gasoline čeno vidis • [PT] Moto-serra a gasolin

## RD-GCS24



**NEW PRODUCT**

art. №	guide bar length /mm/	teeth	gross weight	in carton	BARCODE
076706 RD-GCS13	400	64	7.040 kg	2 pcs	3800972019423



art. №	guide bar length /mm/	teeth	gross weight	in carton	BARCODE
076704 RD-GCS22	350	60	7.040 kg	2 pcs	3800972014336
075104 RD-GCS13	400	64	7.040 kg	2 pcs	3800123169847

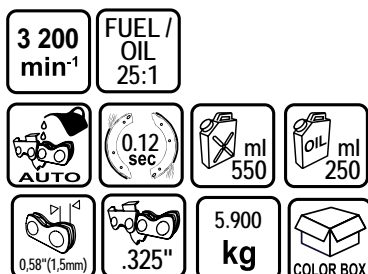

art. №	W	displacement	guide bar length /mm/	teeth	gross weight	in carton	BARCODE
075105 RD-GCS14	2000	52 cm <sup>3</sup>	400	64	6.500 kg	2 pcs	3800123169885
075106 RD-GCS15	2200	58 cm <sup>3</sup>	450	72	6.500 kg	2 pcs	3800123169892

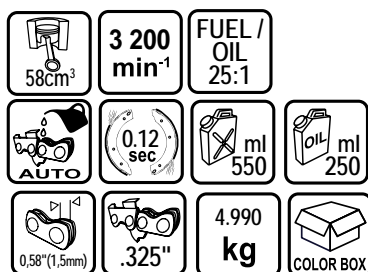

art. №	W	guide bar length /mm/	teeth	gross weight	in carton	BARCODE
076701 RD-GCS19	2200	450	72	6.500 kg	2 pcs	3800972004177
076702 RD-GCS20	2200	450	72	6.500 kg	2 pcs	3800972004184



### RDP-GCS07

45cm <sup>3</sup>	<b>1800 W</b>	<b>3 200 min<sup>-1</sup></b>	18" / 450mm
<b>AUTO</b>	0.12 sec	ml 550	ml 260
.325"	<b>X 72</b>	<b>7.700 kg</b>	<b>COLOR BOX</b>



**RAIDER<sup>®</sup>**  
Pro

**EasyOn**



Art.No	gross weight	in carton	barcode
129993	8.500 kg	2 pcs	3800123133435

### RDP-GCS08

50.7cm <sup>3</sup>	<b>2200 W</b>	<b>3 200 min<sup>-1</sup></b>	18" / 450mm
<b>AUTO</b>	0.12 sec	ml 550	ml 260
0.58" (1.5mm)	.325"	<b>X 72</b>	<b>7.200 kg</b>



**RAIDER<sup>®</sup>**  
Pro

**EasyOn**



Art.No	gross weight	in carton	barcode
129994	8.000 kg	2 pcs	3800123133442

### RDP-GCS21

58cm <sup>3</sup>	<b>2200 W</b>	<b>3 200 min<sup>-1</sup></b>	18" / 450mm	<b>AUTO</b>
0.12 sec	ml 900	ml 250	<b>FUEL / OIL 25:1</b>	0.325"
0.58" (1.5mm)	.325"	<b>X 72</b>	<b>6.900 kg</b>	<b>COLOR BOX</b>



**RAIDER<sup>®</sup>**  
Pro

Art.No	gross weight	in carton	barcode
076703	7.750 kg	2 pcs	3800972004191

### RDP-GCS23

58cm <sup>3</sup>	<b>2800 W</b>	<b>3 200 min<sup>-1</sup></b>	22" / 560mm	<b>AUTO</b>
0.12 sec	ml 900	ml 250	<b>FUEL / OIL 25:1</b>	0.325"
0.58" (1.5mm)	.325"	<b>X 84</b>	<b>4.800 kg</b>	<b>COLOR BOX</b>



**NEW PRODUCT**

**RAIDER<sup>®</sup>**  
Pro

**EasyOn**

Art.No	gross weight	in carton	barcode
076705	8.000 kg	2 pcs	3800972015487

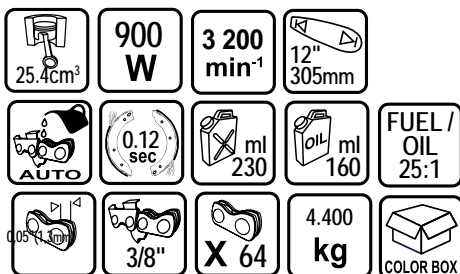

**RDP-GCS18**

Art.No	gross weight	in cartoon	barcode
075109	4.980 kg	2 pcs	3800123174087

**ELECTRIC CHAIN SAW SHARPENER RD-CSS01**

[BG] Машина за точене на вериги • [RO] Aparat de ascutire lant drijba • [SR] Mašina za oštrenje lanca motorke • [MK] Машина за острење за ланец • [RU] Станки для заточки цепей • [SL] Brusilni stroj za brušenje verig • [EL] Τροχιστής αλυσίδας αλυσσπριου • [HR] Stroj za oštrenje lanaca • [FR] Aiguiseur de tronçonneuse électrique • [IT] Affilcoltelli elettrico • [ES] Elektra mastruma motilo • [PT] Apontador de motosserra elétrica

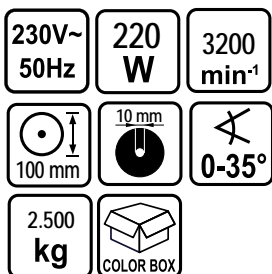

Ø 100 mm

Art.No	gross weight	in cartoon	barcode
140108	2.620 kg	4 pcs	3800123163210

**LOG SPLITTER RD-LGS01T**

[BG] Машина за целене на дърва • [RO] Dispozitiv pentru despicat busteni • [SR] Сераџ за дрва • [MK] Цепач на дрва • [RU] Машина для колки дров • [SL] Serpilec drv • [EL] Τεμαχιστής Ξύλων (Τριφασικός) • [HR] Stroj za cijepanje дрва • [FR] Machine à couper le bois • [IT] Trinciatrice del legno • [ES] Tajpado de ligno • [PT] Rachador de lenha

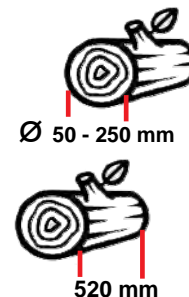
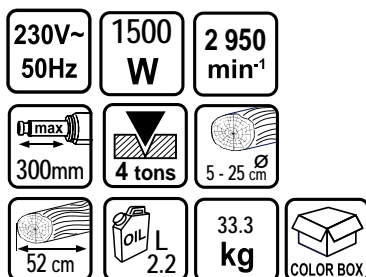

Art.No	gross weight	in cartoon	barcode
129939	37.000 kg	1	3800123123009

**ELECTRIC BLOWER AND SHREDDER**

[BG] Листосъбирач • [RO] Sufianta / aspirator • [SR] Usisač lišća • [MK] Вомкувач за лисја • [RU] Пылесос для листьев • [SL] Sesalnik za listje • [EL] Μηχανής αναρρόφησης φύλλων • [HR] Električni Usisavač / Puhalo Lišća • [FR] Aspirateur à feuilles • [IT] Aspirapolvere a foglia • [ES] Folia polvosuçilo • [PT] Soprador/aspirador eléctrico

**RD-EBV03**

STRAP



VARIABLE SPEED

**BAG CAPACITY 30 L**

Art.No	gross weight	in cartoon	barcode
075522	3.800 kg		3800972002074

## RD-EBV04

230V~ 50Hz	3000 W
SPEED 270 km/h	9000- 15000 min <sup>-1</sup>
13.2 m <sup>3</sup> /min	LEAVES BAG 35 L
4.3 kg	COLOR BOX



STRAP



VARIABLE SPEED



BAG CAPACITY  
35 L

Art.No	gross weight	in carton	barcode
075529	5.300 kg	4 pcs	3800972002050

## GASOLINE BLOWER AND VACUUM RD-6BV05

[BG] Листосъбирач бензинов • [RO] Sufianta / aspirator pentru benzină • [SR] Usisač lišća benzina • [MK] Всмуквач за лисја бензина • [RU] Бензин пылесос для листьев • [SL] Sesalnik za listje • [EL] Μηχανή αναρρόφησης φύλλων • [HR] Električni Usisavač / Puhalo Lišća • [FR] Aspirateur à essence • [IT] Aspirapolvere a benzina • [ES] Gasolina blavilo malplena • [PT] Soprador a gasolina

750 W	6500 min <sup>-1</sup>
SPEED 130m/s	13.2 m <sup>3</sup> /min
FUEL / OIL 25:1	ml 650
LEAVES BAG 30 L	4.700 kg
	COLOR BOX



STRAP



13.2 m<sup>3</sup>/min



BAG CAPACITY  
30 L

Art.No	gross weight	barcode
077401	5.200 kg	3800972003712

## GASOLINE BACKPACK BLOWER RD-GBV06

[BG] Моторна метла • [RO] Aspirator/sufianta pe benzină • [SR] benzinski ranac puhač • [MK] Метла за лисја бензина • [RU] Бензин пылесос для метены • [SL] Sesalnik za listje • [EL] Μηχανή αναρρόφησης φύλλων • [HR] Električni Usisavač / Puhalo Lišća • [FR] Aspirateur à essence • [IT] Aspirapolvere a benzina • [ES] Gasolina blavilo malplena • [PT] Soprador a gasolina

*Двигател: Едноцилиндров, бензинов,  
двухтактов с въздушно охлаждане*

1250 W	7000 min <sup>-1</sup>
SPEED 252m/s	ml 1200
FUEL / OIL 25:1	8.300 kg
	COLOR BOX

**NEW  
PRODUCT**



Art.No	gross weight	barcode
077402	9.500 kg	3800972015630









## ELECTRIC TILLER

[BG] Мотофреза електрическа • [RO] Electrocultor • [SR] Baštenska freza • [MK] Електричен култиватор • [RU] Электрических румпель • [SL] Električni prekopalnik • [EL] Φρεζα Ηλεκτρική • [HR] Električna kopačica • [FR] Motoculteur électrique • [IT] Timone elettrico • [ES] Elektra cultivadora • [PT] Cultivadora

### RD-ET01J

230V~ 50Hz	750 W
400 min <sup>-1</sup>	 300mm
 200mm	 Ø220mm
7.100 kg	 COLOR BOX







Ø 220 mm



TILLER WIDTH  
300 mm

Art.No	gross weight	in cartoon	barcode
095101	8.700 kg	1 pcs	3800123163340

### RD-ET03

230V~ 50Hz	1000 W
430 min <sup>-1</sup>	 365mm
 180mm	 Ø220mm
10.800 kg	 COLOR BOX







Ø 220 mm



TILLER WIDTH  
365 mm

Art.No	gross weight	in cartoon	barcode
095113	15.540 kg	2 pcs	3800972003552

### RD-ET02

230V~ 50Hz	1500 W
200 min <sup>-1</sup>	 450mm
 180mm	 Ø220mm
10.00 kg	 COLOR BOX



Ø 220 mm











TILLER WIDTH  
450 mm

Art.No	gross weight	in cartoon	barcode
095108	13.500 kg	2 pcs	3800123174681

## GASOLINE TILLER

[BG] Мотофреза бензинова • [RO] Motocultor • [SR] Baštenska freza • [MK] Бензинов култиватор • [RU] Культиватор бензиновый • [SL] Bencin prekopalnik • [EL] Βενζίνη ηλεκτρική • [HR] Benzinska vrt freza • [FR] Motoculteur essence • [IT] Motozappa benzina • [ES] Benzina cultivador • [PT] Motocultivador

### RD-T09

 16lcm <sup>3</sup>	3.0 kW	3600 min <sup>-1</sup>	
 600mm	 150-260mm	 Ø270mm	
 ml 1200	 ml 400		
	31 kg	 COLOR BOX	











Ø 270 mm



TILLER WIDTH  
600 mm

Art.No	gross weight	in cartoon	barcode
076904	36.000 kg	1 pcs	3800972015562

### RD-T08





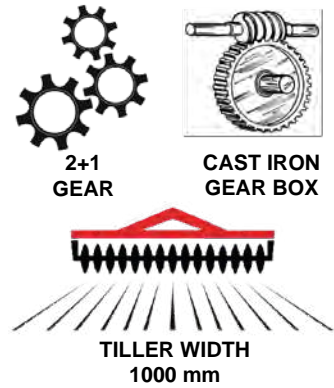
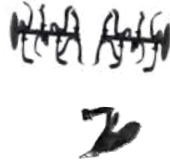



 208cm <sup>3</sup>	 5.2 kW	 2500 min <sup>-1</sup>
 1000mm	 150-350mm	 2+1 GEAR
 3600 ml	 600 ml	 86 kg

 COLOR BOX



Art.No	gross weight	in cartoon	barcode
076903	93.400 kg		3800972015203

### RD-T11

 208cm <sup>3</sup>	 5.2 kW	 2500 min <sup>-1</sup>
 1000mm	 150-350mm	 2+1 GEAR
 3600 ml	 600 ml	 87.00 kg

 COLOR BOX

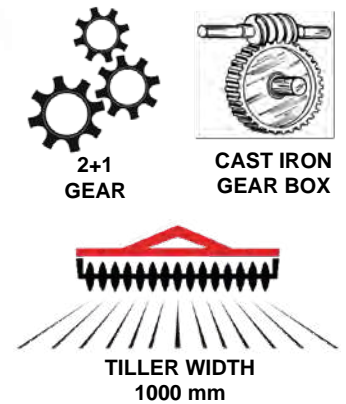

Art.No	gross weight	barcode
076908	99.500 kg	3800972018037

### RD-T03





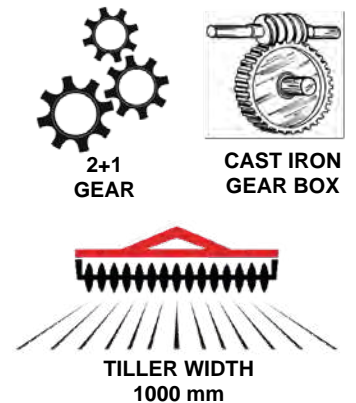



 208cm <sup>3</sup>	 5.2 kW	 2500 min <sup>-1</sup>
 1000mm	 150-350mm	 2+1 GEAR
 3600 ml	 600 ml	 102 kg

 COLOR BOX



Art.No	gross weight	barcode
095102	107.000 kg	3800123170867

### RD-T07

 208cm <sup>3</sup>	 5.2 kW	 2500 min <sup>-1</sup>
 1000mm	 100-350mm	 2+1 GEAR
 3600 ml	 600 ml	 97 kg

 COLOR BOX

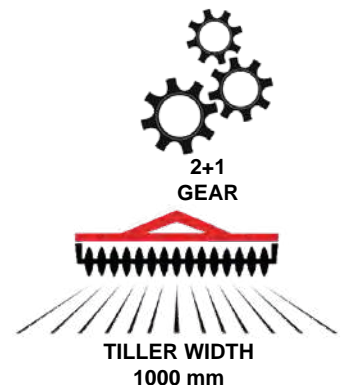

Art.No	gross weight	barcode
095112	107.800 kg	3800972001404



## BELT DRIVEN ROTARY DISC MOWER FOR TILLERS

[BG] Прикачка роторна дискова косачка за мотофреза • [RO] Accesoriu motocultor cu functie de motocosoitoare • [SR] Diskna kosilica na rotoru za glodalicu • [MK] Косилка за дискови на роторот за прицврстување за машина за мелење • [RU] Навесная дисковая косилка для фрезерного станка • [SL] Pritrdilna rotorska diskovna kosilnica za rezkalni stroj • [EL] Κοτσαδόρος δίσκου ρότορα συναρμολόγητος για φρεζόστρμη • [HR] Disčna kosilica na rotoru za glodalicu • [FR] Accessoire tondeuse à disque à rotor pour fraiseuse • [IT] Falciatrice a dischi rotore di attacco per fresatrice • [ES] Aldona rotor-disko-faligilo por muelilo • [PT] Cortador de disco de rotor de acessórios para fresadora

**NEW  
PRODUCT**

Art.No	gross weight	barcode
110292	32.500 kg	3800972015975



### CONNECTOR FOR BELT DRIVEN ROTARY DISC MOWER



Art.No	gross weight	barcode
110293	4.500 kg	3800972016309

## GASOLINE TILLER

[BG] Мотофреза бензинова • [RO] Cultivator benzină • [SR] Baštenska freza • [MK] Бензинов култиватор • [RU] Культиватор бензиновый • [SL] Bencin prekopalnik • [EL] Βενζίνη ηλεκτρική • [HR] Benzinska vrt freza • [FR] Motoculteur essence • [IT] Motozappa benzina • [ES] Benzina cultivador • [PT] Motocultivador

### RD-T06

**2+1  
GEAR**

**TILLER WIDTH  
1400 mm**

Art.No	gross weight	barcode
095111	131.600 kg	3800972000834

### RD-T10

**NEW  
PRODUCT**

**13 hp**

**TILLER WIDTH  
1400 mm**

Art.No	gross weight	barcode
076905	123 kg	3800972015579

## TRAILER FOR POWER TILLER RD-T03

[BG] Ремарке за мотофреза бензинова RD-T03 • [RO] Remorcă • [SR] Prikolica • [MK] Приколка • [RU] Прицеп для мотоблока • [SL] Prikolica • [EL] Τρέιλερ • [HR] Prikolica • [FR] Remorque de remorque de fraissage d'essence • [IT] Rimorchio del rimorchio di macinazione della benzina • [ES] Antaúfilmo de benzina muelejo • [PT] Reboque para trituradora a gasolina

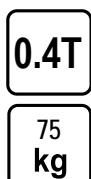
**NEW  
PRODUCT**

**Dimensions: 2650 x 850 x 850 mm**

- Loading area: 1m²
- High pass
- Ground clearance: 200 mm

Art.No	barcode
076907	3800123174544

## EARTH AUGER

[BG] Моторен сярдел • [RO] Motoburghiu • [SR] Motorna bušilica zemlje • [MK] Моторна дупчалка • [RU] Сверло земли газолина • [SL] Vrtalnik za zemljo • [EL] Τριβέλα - Γεωτρύπανο Βενζίνης • [HR] Motorna bušilica za zemlju • [FR] Perceuse à essence • [IT] Trapano a benzina • [ES] Benzina grundo • [PT] Abre-buracos

**NEW  
PRODUCT**

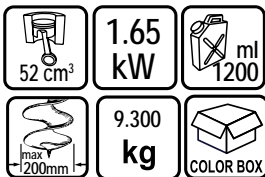

Art.No	gross weight	in cartoon	barcode
095109 RD-EA01	9.880 kg		3800123174858
095114 RD-EA02 with drill bit 200x820mm	13.730 kg		3800972017269

## DRILL FOR EARTH AUGER

[BG] Сврдело за моторен сярдел • [RO] Burghiu de pamant • [SR] Burgije za bušać • [MK] Бургија за моторна дупчалка • [RU] Сверло земли • [SL] Sveder za zemljo • [EL] Αρίδα τριβέλας • [HR] Burgije za motorna bušilica za zemlju • [FR] Forage terrestre • [IT] Trapano a terra • [ES] Tera borilo • [PT] Broca à abre-buracos

Art. №	size	barcode
110267 for RD-EA01	Ø100x820mm	3800123174889



Art. №	size	barcode
110268 for RD-EA01	Ø150x820mm	3800123174896



Art. №	size	barcode
110269 for RD-EA01	Ø200x820mm	3800123174902



## ANTI VIBRATION SYSTEM FOR EARTH AUGER

[BG] Приставка антивибрационна за моторен сярдел • [RO] Cuple anti-vibratii pentru motoburghiu • [SR] Opruga za motorna bušilica zemlje • [MK] Пружина за моторна дупчалка • [RU] Пружина для сверло земли газолина • [SL] Vzmet za vrtalnik za zemljo • [EL] Ελατήριο τριβέλας - γεωτρύπανο βενζίνης • [HR] Opruge za motorna bušilica za zemlju • [FR] Ressort pour perceuse à essence • [IT] Molla per trapano benzina a terra • [ES] Printempo por grunda benzino borilo • [PT] Sistema anti-vibração p/ abre buracos

Art. №	size	barcode
110270 RD-EA01	Ø20x20mm	3800123174957

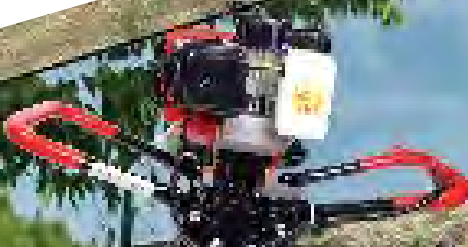



## ELECTRIC SNOW THROWER

[BG] Електрически снегорин • [RO] Plug de zapada • [SR] Čistač za sneg električni • [MK] Чистач за снег електрични • [RU] Снегоуборщик электрический • [SL] Električna snežna freza • [EL] Ηλεκτρικό Εκχιονιστικό • [HR] Freza za snijeg • [FR] Souffleuse à neige électrique • [IT] Spazzaneve elettrico • [ES] Elektra jetaja neĝo • [PT] Limpa-neves elétrico

### RD-ST01

230V~ 50Hz	1300 W	
4000 min <sup>-1</sup>	300mm	150mm
SNOW THROW 6m	5.00 kg	COLOR BOX

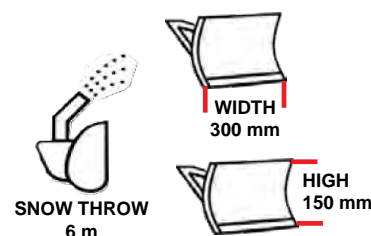

Art.No	gross weight	barcode
095105	6.000 kg	3800123174094

### RD-ST02

230V~ 50Hz	1300 W	
3000 min <sup>-1</sup>	400mm	150mm
SNOW THROW 6m	11.00 kg	COLOR BOX



Art.No	gross weight	barcode
095106	12.000 kg	3800123174100

## GASOLINE SNOW THROWER

[BG] Бензинов снегорин • [RO] Plug de zapada pe benzină • [SR] Benzinska snovflake • [MK] Бензински снег • [RU] Бензиновый снегоочиститель • [SL] Bencin za sneg • [EL] Γερανός χιονιού βενζίνης • [HR] Vacač snijega za benzin • [FR] Souffleuse à essence • [IT] Benzina spazzaneve • [ES] Benzina jetilo • [PT] Limpa-neves a gasolina

### RD-GST03

196 cm <sup>3</sup>	4.1 kW	3600 min <sup>-1</sup>
610mm	510mm	SNOW THROW 11m
GEARS 4+1 rear	3600 ml	600 ml
	50.00 kg	COLOR BOX

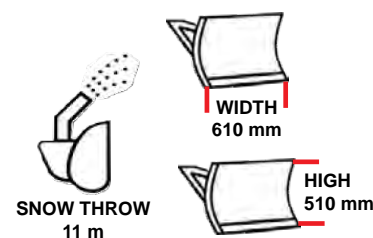

Art.No	gross weight	barcode
076901	54.000 kg	3800972003439

### RD-GST04

252 cm <sup>3</sup>	5.2 kW	3600 min <sup>-1</sup>		
710mm	510mm	SNOW THROW 11m		
GEARS 5+2 rear	3500 ml	600 ml		
	92.00 kg	COLOR BOX		



HEATED  
HAND GRIP



TWO STAGE  
SYSTEM

Self propelled

Art.No	gross weight	barcode
076902	113.000 kg	3800972003446



## GRASS TRIMMER

[BG] Косачка-тример • [RO] Trimmer pentru iarba • [SR] Trimer za travu • [MK] Косилка за трева [RU] Электрический триммер • [SL] Električni obrezovalnik trave • [EL] Ηλεκτρικό χορτοκοπτικό • [HR] Trimer za travu • [FR] Trimmer électrique • [IT] Trimmer elettrico • [ES] Herbo tondilo • [PT] Aparador de relva

### RD-GT26



Art.No	gross weight	in cartoon	barcode
075544	1.500 kg	15 pcs	3800972009431

### RD-GT11Q



Art.No	gross weight	in cartoon	barcode
075507	2.200 kg	8 pcs	3800123163173

### RD-GT21



Art.No	gross weight	in cartoon	barcode
075525	3.230 kg	4 pcs	3800123174155



**ELECTRIC BRUSH CUTTER WITH TRIMMER HEAD DETACHABLE SHAFT RD-EBC03**

[BG] Коса електрическа с корда • [RO] Trimmer pentru gazon • [SR] Trimer za travu •  
 [MK] Рачна косилка електрична • [RU] Электрический триммер - газонокосилка • [SL] Električna kosa •  
 [EL] Θαμνοκοπτικό ηλεκτρικό [HR] Motorna kosa • [FR] Trimmer électrique • [IT] Trimmer elettrico •  
 [ES] Herbo tondilo • [PT] Roçadora elétrica

230V~ 50Hz	1000 W	7300 min <sup>-1</sup>
 350mm	5.00 kg	 COLOR BOX



**CUTTING  
DIAMETER  
350 mm**

Art.No	gross weight	in carton	barcode
075526	5.700 kg	4 pcs	3800123174162

**ELECTRIC BRUSH CUTTER WITH BLADE AND TRIMMER HEAD AND DETACHABLE SHAFT**

[BG] Коса електрическа с нож и корда сгъваема • [RO] Trimmer pentru gazon • [SR] Trimer za travu •  
 [MK] Рачна косилка електрична • [RU] Электрический триммер - газонокосилка • [SL] Električna kosa •  
 [EL] Θαμνοκοπτικό ηλεκτρικό με λαβή • [HR] Motorna kosa • [FR] Débroussailleuse électrique •  
 [IT] Decespugliatore elettrico • [ES] Elektra trançilo • [PT] Roçadora elétrica

**RD-EBC02**

230V~ 50Hz	1200 W	 420mm
 5000min <sup>-1</sup>	 255mm	 COLOR BOX



**CUTTING  
DIAMETER  
WITH CORD  
420 mm**



**CUTTING  
DIAMETER  
WITH BLADE  
255 mm**

Art.No	gross weight	in carton	barcode
075517	6.700 kg	4 pcs	3800123171413

**RD-EBC05**

**NEW  
PRODUCT**

230V~ 50Hz	1200 W	 420mm
 5500min <sup>-1</sup>	 420mm	 COLOR BOX



**CUTTING  
DIAMETER  
WITH CORD  
420 mm**



**CUTTING  
DIAMETER  
WITH BLADE  
420 mm**

Art.No	gross weight	in carton	barcode
075546	5.750 kg	4 pcs	3800972015388

**RD-EBC06**

**NEW  
PRODUCT**

230V~ 50Hz	1200 W	 420mm
 5500min <sup>-1</sup>	 420mm	 COLOR BOX



**CUTTING  
DIAMETER  
WITH CORD  
420 mm**



**CUTTING  
DIAMETER  
WITH BLADE  
420 mm**

Art.No	gross weight	barcode
075547	7.000 kg	3800972015395

## RD-EBC07



**NEW  
PRODUCT**



**CUTTING  
DIAMETER  
WITH CORD  
420 mm**

Art.No	gross weight	barcode
075548	7.300 kg	3800072015401

## GASOLINE BRUSH CUTTER WITH BLADE AND TRIMMER HEAD

[BG] Коса бензинова с нож и корда съваема • [RO] Motocoasa pe benzina • [SR] Motorni trimmer za travu [MK] Бензински тример  
[RU] Бензиновый триммер - газонокосилка • [SL] Motorna kosa • [EL] Βενζινη Θαιμνοκοπτική • [HR] Motorna kosa •  
[FR] Débroussaillseuse à essence avec lame et tête de coupe [IT] Decespugliatore a benzina con lama e testina •  
[ES] Trancilo por brulajo kun klingo kaj tondilo • [PT] Roçadora a gasolina

## RD-GBC08



• Двигател: Едноцилиндров, бензинов, двутактов  
с въздушно охлаждане  
• Engine type: Air cooling, single cylinder, two stroke

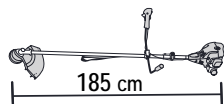

**CUTTING  
DIAMETER  
WITH CORD  
440 mm**



**CUTTING  
DIAMETER  
WITH BLADE  
255 mm**

Art.No	gross weight	barcode
075504	9.420 kg	3800123162770

## RD-GBC07S

• Двигател: Едноцилиндров, бензинов, двутактов  
с въздушно охлаждане  
• Engine type: Air cooling, single cylinder, two stroke

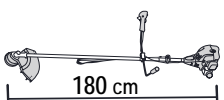

**CUTTING  
DIAMETER  
WITH CORD  
440 mm**



**CUTTING  
DIAMETER  
WITH BLADE  
255 mm**

Art.No	gross weight	barcode
097102	10.000 kg	3800123161292

## RD-GBC22

• Двигател: Едноцилиндров, бензинов, двутактов  
с въздушно охлаждане  
• Engine type: Air cooling, single cylinder, two stroke

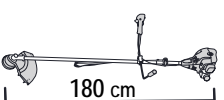
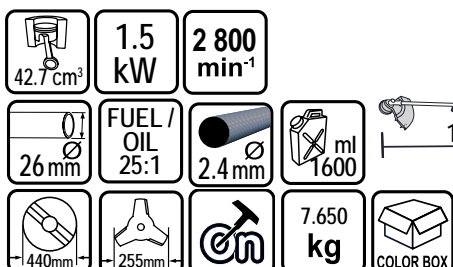

**NEW  
PRODUCT**



**CUTTING  
DIAMETER  
WITH CORD  
440 mm**



**CUTTING  
DIAMETER  
WITH BLADE  
255 mm**

Art.No	gross weight	barcode
075549	19.000 kg	3800972015463



**RD-GBC10**

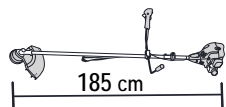

42.7 cm <sup>3</sup>	<b>1.5 kW</b>	<b>2 800 min<sup>-1</sup></b>
26 mm	<b>FUEL / OIL 25:1</b>	2.4 mm
440mm	255mm	<b>8 kg</b>

• Двигател: Едноцилиндров, бензинов, двутактов с въздушно охлаждане  
 • Engine type: Air cooling, single cylinder, two stroke



**CUTTING DIAMETER WITH CORD 440 mm**



**CUTTING DIAMETER WITH BLADE 255 mm**

Art.No	gross weight	in cartoon	barcode
075510	9.160 kg	2 pcs	3800123166433

**RD-GBC20**

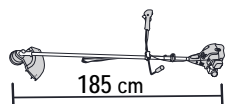

52 cm <sup>3</sup>	<b>1.8 kW</b>	<b>8 800 min<sup>-1</sup></b>
24 mm	<b>FUEL / OIL 25:1</b>	2.4 mm
440mm	255mm	<b>8.500 kg</b>

• Двигател: Едноцилиндров, бензинов, двутактов с въздушно охлаждане  
 • Engine type: Air cooling, single cylinder, two stroke



**CUTTING DIAMETER WITH CORD 440 mm**



**CUTTING DIAMETER WITH BLADE 255 mm**

Art.No	gross weight	in cartoon	barcode
075543	9.340 kg	2 pcs	3800972009035

**RD-GBC14**

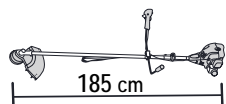

52 cm <sup>3</sup>	<b>1.8 kW</b>	<b>2 800 min<sup>-1</sup></b>
26 mm	<b>FUEL / OIL 25:1</b>	2.4 mm
440mm	255mm	<b>9.000 kg</b>

• Двигател: Едноцилиндров, бензинов, двутактов с въздушно охлаждане  
 • Engine type: Air cooling, single cylinder, two stroke



**CUTTING DIAMETER WITH CORD 440 mm**



**CUTTING DIAMETER WITH BLADE 255 mm**

Art.No	gross weight	in cartoon	barcode
075534	9.950 kg	2 pcs	3800123174247

**RDP-GBC15**

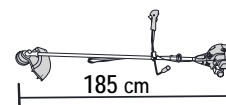

52 cm <sup>3</sup>	<b>1.8 kW</b>	<b>7 500 min<sup>-1</sup></b>
28 mm	<b>FUEL / OIL 25:1</b>	2.4 mm
440mm	255mm	<b>11.000 kg</b>

• Двигател: Едноцилиндров, бензинов, двутактов с въздушно охлаждане  
 • Engine type: Air cooling, single cylinder, two stroke



**ANTIVIBRATION SYSTEM**



**CUTTING DIAMETER WITH CORD 440 mm**



**CUTTING DIAMETER WITH BLADE 255 mm**

Art.No	gross weight	in cartoon	barcode
075535	11.940 kg		3800123174384

## RDP-GBC21

**NEW PRODUCT**

• Двигател: Едноцилиндров, бензинов, двутактов с въздушно охлаждане  
• Engine type: Air cooling, single cylinder, two stroke

54 cm <sup>3</sup>	<b>2.2 kW</b>	<b>3 000 min<sup>-1</sup></b>
28 mm	<b>FUEL / OIL 25:1</b>	2.4 mm
440 mm	ml 800	<b>4.5 kg</b>
255 mm		<b>COLOR BOX</b>



**RAIDER<sup>®</sup> Pro**  
**EasyOn**



**CUTTING DIAMETER WITH CORD**  
**440 mm**



**CUTTING DIAMETER WITH BLADE**  
**255 mm**

Art.No	gross weight	in cartoon	barcode
075550	5.150 kg		3800972015470

## RD-GBC11

**4 STROKE ENGINE**

• Двигател: Едноцилиндров, бензинов, четиритактов с въздушно охлаждане  
• Engine type: Air cooling, single cylinder, four stroke

40 cm <sup>3</sup>	<b>0.8 kW</b>	<b>3 000 min<sup>-1</sup></b>
440 mm	26 mm	2.4 mm
255 mm	ml 1600	<b>8.00 kg</b>
		<b>COLOR BOX</b>

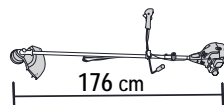

**CUTTING DIAMETER WITH CORD**  
**440 mm**



**CUTTING DIAMETER WITH BLADE**  
**255 mm**

Art.No	gross weight	barcode
075513	8.880 kg	3800123171246

## POLE SAW HEAD WITH TUBE FOR GASOLINE BRUSH CUTTER RD-GBC10, GBC11 AND GBC20

[BG] Кастръчка за бензинова коса • [RO] Cap d'ubraj prelunctor pentru motocoasa • [SR] Lančana testera za grane • [MK] Верижна пила за гранки • [RU] Пила для обрезки ветвей для • [SL] Verižna žaga za veje • [EL] Αλυστροπίνο κοπταρίου μπαταρίας • [HR] Teleskopska pila za motorna kosa • [FR] Scie pour branches de taille pour • [IT] Visto per i rami di potatura per • [ES] Vidis por rikoltitiloj • [PT] Serra de podar c/ tubo p/ corta-sebas a gasolina

10" 250mm		0.50" (1.3mm)
<b>1.300 kg</b>		<b>COLOR BOX</b>



Art.No	gross weight	in cartoon	barcode
110216	2.000 kg		3800123161377

## CHAIN FOR POLE SAW RD-GBC10, GBC11 AND GBC20

[BG] Верига за кастръчка • [RO] Lant pentru ferestrau el. cu lant • [SR] Lanac za lančanu testeru za grane • [MK] Ланец за верижна пила за гранки • [RU] Цепь для пила обрезки ветвей • [SL] Veriga za žaga za veje • [EL] Αλυσίδα αλυστροπίνο κοπταρίου μπαταρίας • [HR] Lanac za teleskopska pila • [FR] Chaîne pour tronçonner les branches • [IT] Catena per rami di taglio sega • [ES] Čeno por segbetbrancoj • [PT] Corrente moto-serra



10" 250mm	0.50" (1.3mm)
-----------	---------------

Art.No	gross weight	in cartoon	barcode
140111	0.130 kg	50 pcs	3800123166662

## GUIDE BAR FOR POLE SAW RD-GBC10, GBC11 AND GBC20

[BG] Водеща шина за кастръчка • [RO] Lama ghidaj pentru ferestrau el. cu lant • [SR] Vodič lanca za lančanu testeru za grane • [MK] Водич за ланец за пила за гранки • [RU] Направляющая шина для пила обрезки ветвей • [SL] Meč za veriga za žaga za veje • [EL] Λαμα για αλυστροπίνο κοπταρίου μπαταρίας • [HR] Vodilica za teleskopska pila • [FR] Pneu de guidage pour la coupe de scie • [IT] Pneumatico di guida per taglio di seghe • [ES] Gvidu pneúo por segcincigilo • [PT] Guia de corte p/motoserra



10" 250mm	0.50" (1.3mm)
-----------	---------------

Art.No	gross weight	in cartoon	barcode
141303	0.390 kg	20 pcs	3800123166679



## HEDGE TRIMMER HEAD AND TUBE FOR GASOLINE BRUSH CUTTER RD-GBC10, RD-GBC11

[BG] Резачка за храсти за бензинова коса • [RO] Trimmer pt. gard viu • [SR] Trimer za zivu ogradu • [MK] Косилка за жива ограда • [RU] Садовые ножницы-кусторезы • [SL] Škarje za živo mejo • [EL] Φαλίδι μπορντουρας • [HR] Glava i cijev za rezanje živice za rezač četke za benzin • [FR] Tête et tube de taille-haie pour débroussailluse à essence • [IT] Testina tagliasiapi e tubo per decespugliatore a benzina • [ES] Štranča kapo kaj tubo • [PT] Cabeça corta-sebes p/ roçadora a gasolina



Art.No	gross weight	barcode
110272	2.620 kg	3800972001732

## TILLER ATTACHMENT FOR GASOLINE BRUSH CUTTER

[BG] Фреза за бензинова коса • [RO] Sapatoare pentru motocoasa • [SR] Glodalica za benzin • [MK] Секач за мелење на бензин • [RU] Бензиновый фрезер • [SL] Bencinski rezkaro • [EL] Φρεζάρισμα φρεζάρισμα βενζίνης • [HR] Rezač benzina • [FR] Fraise à essence • [IT] Fresa per benzina • [ES] Muelanta kurtenon • [PT] Fresa a gasolina



Art.No	size	gross weight	barcode
110288	320mm	1.500 kg	3800972015494

## EXTENSION POLE FOR GASOLINE BRUSH CUTTER

[BG] Удължение за бензинова коса • [RO] Tija extensie pentru motocoasa • [SR] Prođužetak za kosu sa benzinom • [MK] Продолжување за бензинска коса • [RU] Наравивание для бензиновых фрезер • [SL] Bencinski rezkaro • [EL] Επέκταση για μαλλιά βενζίνης • [HR] Prođužetak za benzinsku kosu • [FR] Extension pour cheveux à essence • [IT] Estensione per capelli benzina • [ES] Etendaño por benzina haroj • [PT] Extensão para cabelos a gasolina



Art.No	size	gross weight	barcode
110289	1m	0.900 kg	3800972015500



## POLE SAW RD-PS01

[BG] Кастрачка • [RO] Fierastrau electric telescopic de taiat crengi • [SR] Lančana testera za grane • [MK] Верижна пила за гранки • [RU] Пила для обрезки ветвей • [SL] Verižna žaga za veje • [EL] Αλυσσπρίοιο κονταριού μπαταρίας • [HR] Teleskopska pila za motorna kosa • [FR] Scie pour branches de taille pour • [IT] Visto per i rami di potatura per • [ES] Vidis por rikoltiloj • [PT] Serra de podar corta-sebes a gasolina

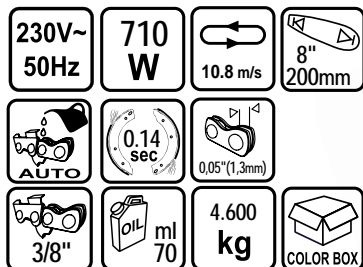
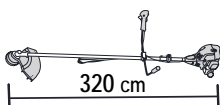

Art.No	gross weight	in cartoon	barcode
075703	6.670 kg	2 pcs	3800123163784

## CHAIN FOR POLE SAW FOR RD-PS01

[BG] Верига за кастрачка • [RO] Lanț pentru ferestrau el. cu lanț • [SR] Lanac za lančanu testeru za grane • [MK] Ланец за верижна пила за гранки • [RU] Цепь для пила обрезки ветвей • [SL] Veriga za žaga za veje • [EL] Αλυσίδα αλυσοπίρινο κονταριού μπαταρίας • [HR] Lanac za teleskopska pila • [FR] Chaîne pour tronçonner les branches • [IT] Catena per rami di taglio sega • [ES] Čeno por segčetbrančoj • [PT] Corrente moto-serra



Art.No	gross weight	in cartoon	barcode
140110	0.120 kg	50 pcs	3800123163791

## GUIDE BAR FOR POLE SAW FOR RD-PS01

[BG] Водеща шина за кастрачка • [RO] Lama ghidaj pentru ferestrau el. cu lanț • [SR] Vodič lanca za lančanu testeru za grane • [MK] Водич за ланец за пила за гранки • [RU] Направляющая шина для пила обрезки ветвей • [SL] Meč za veriga za žaga za veje • [EL] Λαμα για αλυσοπίρινο κονταριού μπαταρίας • [HR] Vodilica za teleskopska pila • [FR] Pneu de guidage pour la coupe de scie • [IT] Pneumatico di guida per taglio di seghe • [ES] Gvidu pneūo por segciniglio • [PT] Guia de corte p/motoserra



Art.No	gross weight	in cartoon	barcode
141302	0.310 kg	10 pcs	3800123163807



## LAWN MOWER

[BG] Косачка • [RO] Masina de tuns iarba • [SR] Kosачice za travu • [MK] Косилка за трава • [RU] Электрическая газонокосилка • [SL] Električna kosilnica • [EL] ηλεκτρική μηχανή γκαζόν • [HR] Električna kosilica • [FR] Tondeuse à gazon • [IT] Tosaerba elettrico • [ES] Gazontondilo • [PT] Corta relvas

### RD-LM30

230V~  
50Hz

1200  
W

**NEW  
PRODUCT**



3700  
min<sup>-1</sup>



20-40-60mm

6.5  
kg



m<sup>2</sup> 400

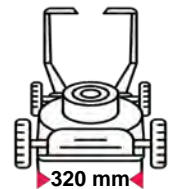

Art.No	gross weight	barcode
075330	7.600 kg	3800972015517



### BLADE 320MM FOR RD-LM30

Art.No	barcode
110294	3800972019485



### RD-LM35

230V~  
50Hz

1300  
W

**NEW  
PRODUCT**



3700  
min<sup>-1</sup>



25-55 mm

8  
kg



m<sup>2</sup> 400



Art.No	gross weight	barcode
075335	8.850 kg	3800972015654



### BLADE 320MM FOR RD-LM35

Art.No	barcode
110299	3800972019539





**RD-LM 31**

**NEW PRODUCT**

230V~ 50Hz	1400 W
330mm	3400 min <sup>-1</sup>
30L	20-40-60mm
7.2 kg	COLOR BOX

m<sup>2</sup> 500



Art.No	gross weight	barcode
075331	8.400 kg	3800972015524



**BLADE FOR RD-LM31**

Art.No	barcode
110295	3800972019492

**RD-LM 32**

**NEW PRODUCT**

230V~ 50Hz	1600 W
360mm	3500 min <sup>-1</sup>
40L	25-55mm
12 kg	COLOR BOX

m<sup>2</sup> 700

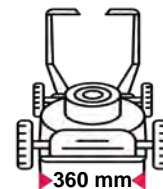

Art.No	gross weight	barcode
075332	12.500 kg	3800972015531



**BLADE FOR RD-LM32**

Art.No	barcode
110296	3800972019508

**SET LAWN MOWER AND GRASS TRIMMER RD-LMGT01**

[BG] Комплект косачка и триммер • [RO] Masina de tuns iarba & trimmer • [SR] Kosilica za travu & trimer • [MK] Косилка & тример • [RU] Косилка за трава и триммера • [SL] kosilnica & trimer • [EL] Μηχανή γκαζόν • [HR] Kosačice za travu & trimer • [FR] Tondeuse à gazon & trimer • [IT] Tosaerba elettrico & Trimer • [ES] Gazontondilo & trimer • [PT] Kit corta relvas e corta sebes

**LAWN MOWER**

230V~ 50Hz	1600 W	3500 min <sup>-1</sup>
360mm	35L	
25-55mm	12 kg	COLOR BOX

**GRASS TRIMMER**

230V~ 50Hz	250 W	12000min <sup>-1</sup>
220mm	1.2mm	1.200 kg
		COLOR BOX



Art.No	gross weight	barcode
075327	13.500 kg	3800972009424

**LAWN MOWER**

[BG] Косачка • [RO] Masina de tuns iarba • [SR] Kosačice za travu • [MK] Косилка за трава • [RU] Электрическая газонокосилка • [SL] Električna kosilnica • [EL] ηλεκτρική μηχανή γκαζόν • [HR] Električna kosilica • [FR] Tondeuse à gazon • [IT] Tosaerba elettrico • [ES] Gazontondilo • [PT] Corta relvas

**RD-LM33**

**NEW PRODUCT**

230V~ 50Hz	1800 W	3300 min <sup>-1</sup>
380mm	50L	
20-70mm	10.950 kg	COLOR BOX

m<sup>2</sup> 800

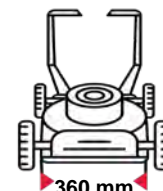

Art.No	gross weight	barcode
075333	13.200 kg	3800972015548



**BLADE FOR RD-LM33**

Art.No	barcode
110295	3800972019492

## RD-LM34

**NEW  
PRODUCT**

230V~  
50Hz

2000  
W

3300  
min<sup>-1</sup>



12.800  
kg



m<sup>2</sup> 1000

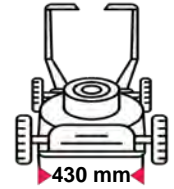

Art.No	gross weight	barcode
075334	14.400 kg	3800972015555

### BLADE FOR RD-LM34

Art.No	barcode
110298	3800972019522



## RD-LM23

**NEW  
PRODUCT**

36  
V

2x4  
Ah

2x18  
V

3500  
min<sup>-1</sup>



10.200  
kg



m<sup>2</sup> 500

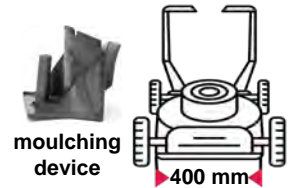

Art.No	gross weight	barcode
075322	17.500 kg	3800972003620

art. No	V	BARCODE
032124	230	3800972003675

art. No	V	mAh	BARCODE
131147	18	4000	3800972003668



ACCESSORIES PNEUMATICS RAIDER MACHINES R20 SYSTEM





# SCARIFIER AND AERATOR 2 IN 1

[BG] Аератор • [RO] Scarificator 2 in 1 • [SR] Serifikator i aerator • [MK] Скарификатор и аератор • [RU] Скарификатор и аэратор • [SL] Škarje in aerator • [EL] Διασκορπιστής και αεριστήρας • [HR] Šerifikator i aerator • [FR] Scarificateur et aérateur • [IT] Scarificatore e aeratore • [ES] Scarifier kaj aeratoro • [PT] Escarificador e aerador

**RD-ESC01**

**NEW  
PRODUCT**

**2in1**

230V~ 50Hz	1400 W	4200 min <sup>-1</sup>
30L	5x CENTRAL WORKING DEPTH ADJUSTMENT	LONG LIFE BLADES 320mm
LONG LIFE HIGH-GRADE STEEL 320mm	10.2 kg	COLOR BOX

**m<sup>2</sup> 1200**



**LONG LIFE BLADES  
320 mm**

Art.No	gross weight	barcode
075337	11.200 kg	3800972015920

**RD-ESC02**

**NEW  
PRODUCT**

**2in1**

230V~ 50Hz	1600 W	4000 min <sup>-1</sup>
50L	5x CENTRAL DEPTH ADJUSTMENT	LONG LIFE BLADES 320mm
LONG LIFE HIGH-GRADE STEEL 320mm	9.600 kg	COLOR BOX

**m<sup>2</sup> 1400**



**LONG LIFE BLADES  
320 mm**



Art.No	gross weight	barcode
075338	11.500 kg	3800972015937

# SHREDDER

[BG] Клонотрошачка • [RO] Tocator frunze si crengi • [SR] Rezač grana • [MK] Уништувач за гранки • [RU] Шредер для веток • [SL] Shredder za veje • [EL] Τεμαχίζων • [HR] Shredder • [FR] Shredder • [IT] Distruttore • [ES] Shredder [PT] Destruidora

## RD-ESH01

**NEW  
PRODUCT**

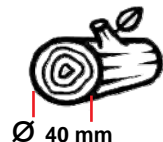

230V~ 50Hz	2400 W	4500 min <sup>-1</sup>
 Ø40	13.5 kg	 COLOR BOX



Art.No	gross weight	barcode
075336	14.500 kg	3800972015944

## RD-ESH02

**NEW  
PRODUCT**

230V~ 50Hz	2800 W	42 min <sup>-1</sup>
50 L	 Ø45	24.600 kg
		 COLOR BOX

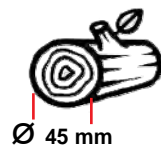

Art.No	gross weight	barcode
075339	25.500 kg	3800972015951

# GASOLINE LAWN MOWER RD-GLM01S

[BG] Косачка бензинова • [RO] Motocoasa pe benzina • [SR] Kosačica benzinska • [MK] Бензинска косилка за трева • [RU] Бензиновая газонокосилка • [SL] Bencina kosilnica • [EL] Χλοοκοπτικός μηχανής γκαζόν • [HR] Motorna kosilica • [FR] Tondeuse à essence • [IT] Rasaerba a benzina • [ES] Gasolina gazono • [PT] Corta relvas a gasolina

• Двигател: Едноцилиндров, бензинов, четиритактов с въздушно охлаждане  
• Engine type: Air cooling, single cylinder, four stroke

 125 cm <sup>3</sup>	2000 W	3600 min <sup>-1</sup>
 40L	 ml 1500	 400mm
 25-75mm	 15.5 kg	 COLOR BOX

m<sup>2</sup> 900

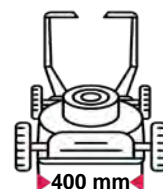

Art.No	gross weight	barcode
110105	20.080 kg	3800123141546









# GASOLINE LAWN MOWER SELF-PROPELLED

[BG] Косачка бензинова самоходна • [RO] Motocoasa pe benzina • [SR] Kosačica benzinska • [MK] Бензинска косилка за трева • [RU] Бензиновая газонокосилка • [SL] Bencina kosilnica • [EL] Χλοοκοπτική μηχανής γκαζόν • [HR] Motorna kosilica • [FR] Tondeuse à essence autopropulsée • [IT] Rasaerba a benzina semovente • [ES] Bencina gazetara tondilo • [PT] Corta relvas a gasolina

## RD-GLM07

**NEW  
PRODUCT**

• Двигател: Едноцилиндров, бензинов, четиритактов с въздушно охлаждане  
• Engine type: Air cooling, single cylinder, four stroke

 125cm <sup>3</sup>	<b>2000 W</b>	<b>2900 min<sup>-1</sup></b>
 45L	 ml 1300	 410mm
 25-75mm	 24.00 <b>kg</b>	 <b>m<sup>2</sup> 1200</b>

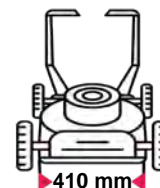

Art.No	gross weight	barcode
075002	26.000 kg	3800972015296

### BLADE FOR RD-GLM07

Art.No	barcode
110300	3800972019546

## RD-GLM08

**NEW  
PRODUCT**

• Двигател: Едноцилиндров, бензинов, четиритактов с въздушно охлаждане  
• Engine type: Air cooling, single cylinder, four stroke

4 functions in 1 machine

 144cm <sup>3</sup>	<b>2500 W</b>	<b>2800 min<sup>-1</sup></b>	 8 x CENTRAL WORKING DEPTH ADJUSTMENT
 65L	 ml 800	 460mm	 ml 500
 30-80mm	 27.6 <b>kg</b>	 <b>m<sup>2</sup> 1600</b>	



**4in1**



Art.No	gross weight	barcode
075003	31.200 kg	3800972015289

### BLADE FOR RD-GLM08







Art.No	barcode
110301	3800972019553

## RD-GLM05



• Двигател: Едноцилиндров, бензинов, четиритактов с въздушно охлаждане  
• Engine type: Air cooling, single cylinder, four stroke

4 functions in 1 machine

 150cm <sup>3</sup>	<b>3200 W</b>	<b>2600 min<sup>-1</sup></b>
 55L	 ml 800	 460mm
 25-75mm	 27 <b>kg</b>	 <b>m<sup>2</sup> 1600</b>



**4in1**



Art.No	gross weight	barcode
075318	30.030 kg	3800123174575

### RD-GLM09

**NEW PRODUCT**

4 functions in 1 machine

196cm <sup>3</sup>	<b>3200 W</b>	<b>2800 min<sup>-1</sup></b>	65L
ml 850	510mm	ml 450	<b>8x</b> ↑ ↓ CENTRAL WORKING DEPTH ADJUSTMENT
30-80mm		<b>34 kg</b>	COLOR BOX

**4 in 1**  
**m<sup>2</sup> 1900**



• Двигател: Едноцилиндров, бензинов, четиритактов с въздушно охлаждане  
• Engine type: Air cooling, single cylinder, four stroke

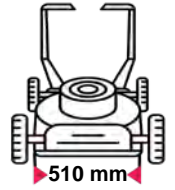

Art.No	gross weight	barcode
075004	38.000 kg	3800972015302

### BLADE FOR RD-GLM09

Art.No	barcode
110302	3800972019560

### RD-GLM10

**NEW PRODUCT**

5 functions in 1 machine

196cm <sup>3</sup>	<b>3200 W</b>	<b>2800 min<sup>-1</sup></b>	70L
ml 850	530mm	ml 450	<b>8x</b> ↑ ↓ CENTRAL WORKING DEPTH ADJUSTMENT
25-55mm		<b>37 kg</b>	COLOR BOX

**5 in 1**  
**m<sup>2</sup> 2500**



• Двигател: Едноцилиндров, бензинов, четиритактов с въздушно охлаждане  
• Engine type: Air cooling, single cylinder, four stroke

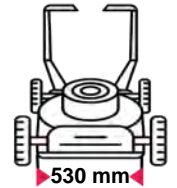

Art.No	gross weight	barcode
075005	40.000 kg	3800972015319

### RD-GLM11 SOLO

**NEW PRODUCT**

• Двигател: Едноцилиндров, бензинов, четиритактов с въздушно охлаждане  
• Engine type: Air cooling, single cylinder, four stroke

5 functions in 1 machine

173cm <sup>3</sup>	<b>3700 W</b>	<b>2800 min<sup>-1</sup></b>	70L
ml 850	530mm	ml 450	<b>8x</b> ↑ ↓ CENTRAL WORKING DEPTH ADJUSTMENT
25-75mm		<b>38 kg</b>	COLOR BOX

**5 in 1**  
**m<sup>2</sup> 2500**



**ELECTRIC STARTER**



Art.No	gross weight	barcode
075006	40.000 kg	3800972015326

### RD-GLM12

**NEW PRODUCT**

• Двигател: Едноцилиндров, бензинов, четиритактов с въздушно охлаждане  
• Engine type: Air cooling, single cylinder, four stroke

5 functions in 1 machine

173cm <sup>3</sup>	<b>3700 W</b>	<b>2800 min<sup>-1</sup></b>	70L
ml 1300	560mm	ml 600	<b>8x</b> ↑ ↓ CENTRAL WORKING DEPTH ADJUSTMENT
30-90mm		<b>39 kg</b>	COLOR BOX

**5 in 1**  
**m<sup>2</sup> 3000**

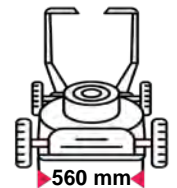

Art.No	gross weight	barcode
075007	41.000 kg	3800972015333

### BLADE FOR RD-GLM12

Art.No	barcode
110303	3800972019577



## SICKLE BAR GASOLINE MOWER RD-SBM01

[BG] Косачка бензинова палцова • [RO] Motocositoare • [SR] Kosačica benzinska • [MK] Бензинска косилка за трева  
 • [RU] Бензиновая газонокосилка • [SL] Bencina kosilnica • [EL] Χλοοκοπτικός μηχανής γκαζόν • [HR] Motorna kosilica •  
 [FR] Tondeuse à essence autopropulsée • [IT] Rasaerba a benzina semovente • [ES] Benzina gazetara tondilo • [PT] Corta relvas a gasolina

**NEW  
PRODUCT**

• Двигател: Едноцилиндров, бензинов, четритактов с въздушно охлаждане  
 • Engine type: Air cooling, single cylinder, four stroke

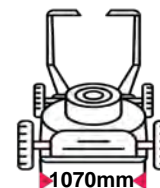

Art.No	gross weight	barcode
075008	67.500 kg	3800972015340

## GASOLINE SCARIFIER RD-GSC03

[BG] Аератор бензинов • [RO] Scarificator pe benzina • [SR] Serifikator i aerator • [MK] Скарифikator и аератор • [RU] Скарифikator и азратор •  
 [SL] Škarje in aerator • [EL] Διασκορπιστής και αεριστήρας • [HR] Šerifikator i aerator • [FR] Scarificateur et aérateur • [IT] Scarificatore e aeratore •  
 [ES] Scarifier kaj aeratoro • [PT] Escarificador e aerador

**NEW  
PRODUCT**

• Двигател: Едноцилиндров, бензинов, четритактов с въздушно охлаждане  
 • Engine type: Air cooling, single cylinder, four stroke



Art.No	gross weight	in cartoon	barcode
075009	40.000 kg		3800972015357

## CORDLESS GRASS AND SHRUB SHEARS

[BG] Ножица за трева и храсти акумулаторна • [RO] Foarfeca iarba si arbusti cu acumulator [SR] Akumulatorske makaze za travu i živu ogradu • [MK] Акумулаторски ножици за трева и жива ограда • [RU] Акумулаторные ножницы-кусторезы • [SL] Akumulatorski škarje za živo mejo • [EL] Ψαλίδι ιμτορνιουρας ιμταταρίας • [HR] Akumulatorske škare za travu i živicu • [FR] Cisailles à gazon et arbustes sans fil • [IT] Cesioie per erba e cesioie a batteria • [ES] Sendratraj tondiloj de herbo kaj arbusto • [PT] Corta-sebas a bateria

Art.No	V	weight	gross weight	in cartoon	barcode
075531 RD-GSSL01	3.6	1.200 kg	1.160 kg	10 pcs	3800123174216
075532 RD-GSSL02	7.2	1.400 kg	1.200 KG	10 pcs	3800123174223

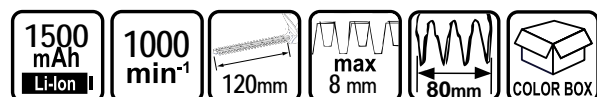

# HEDGE TRIMMER

[BG] Рязачка за храсти • [RO] Trimmer pt. gard viu • [SR] Trimer za zivu ogradu • [MK] Косилка за жива ограда • [RU] Садовые ножницы-кусторезы • [SL] Škarje za živo mejo • [EL] Ψαλίδι Μπροντρουρας Ηλεκτρικο • [HR] Električne škare za živicu • [FR] Taille-haie • [IT] Tagliasiepi • [ES] Heğdezurilo • [PT] Costa-sebes

## RD-HT06

230V~ 50Hz	550 W
1500 min <sup>-1</sup>	510mm
max 20 mm	2 kg
	COLOR BOX



LENGHT 510 mm

Art.No	gross weight	in cartoon	barcode
075706	2.880 kg	4 pcs	3800123174872

## RD-HT05

230V~ 50Hz	710 W
1700 min <sup>-1</sup>	610mm
max 24 mm	4 kg
	COLOR BOX



LENGHT 610 mm



ROTATABLE  
HANDLE



ERGONOMIC  
HANDLE

Art.No	gross weight	in cartoon	barcode
075705	4.130 kg	4 pcs	3800123174834

## GASOLINE HEDGE TRIMMER RD-GHT02

[BG] Рязачка за храсти бензинова • [RO] Trimmer pt. gard viu • [SR] trimer za zivu ogradu • [MK] Косилка за жива ограда • [RU] Садовые ножницы-кусторезы • [SL] škarje za živo mejo • [EL] Ψαλίδι Μπροντρουρας • [HR] Benzinske škare za živicu • [FR] Taille-haie • [IT] Tagliasiepi • [ES] Heğdezurilo • [PT] Corta-sebes a gasolina

22.5 cm <sup>3</sup>	650 W	6500 min <sup>-1</sup>	
FUEL / OIL 25:1	ml 500	6.7 kg	
600mm	max 23 mm	COLOR BOX	



ROTATABLE  
HANDLE

Art.No	gross weight	barcode
075702	7.250 kg	3800123161384

## KNAPSACK SPRAYER RD-BKMD03

[BG] Прыскачка • [RO] Vermorel • [SR] Prskalica • [MK] Пумпа прскалка • [RU] Рюкзак опрыскиватель • [SL] Škropilnica • [EL] Ψεκαστήρας σακιδίου • [HR] Prskalica • [FR] Pulvérisateur à dos • [IT] Spruzzatore a zaino • [ES] Pulverizador mochila • [PT] Pulverizador manual

**NEW PRODUCT**

BATTERY & CHARGER INCLUDED

12 V	10 Ah
max. 0.62 MPa	0.2-0.45 MPa
	16 L
	LIQUID ≥ 5 L/min
	8 m
1.5 m	7.00 kg
	COLOR BOX

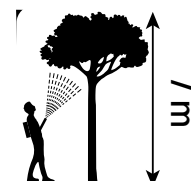

CAPACITY 16 L

Art.No	gross weight	barcode
098102	7.600 kg	3800972009226



## KNAPSACK SPRAYER RD-BKMD04

[BG] Пръскачка • [RO] Vermorel cu carucior si port USB • [SR] Prskalica • [MK] Пумна прскалка • [RU] Рюкзак опрыскиватель [SL] Škropilnica • [EL] Ψεκαστήρας σακιδίων • [HR] Prskalica • [FR] Pulvérisateur à dos • [IT] Spruzzatore a zaino • [ES] Pulverizador mochila • [PT] Pulverizador manual

**NEW  
PRODUCT**
**BATTERY & CHARGER  
INCLUDED**
**TROLLEY  
and  
USB CHARGER  
FOR MOBILE PHONE  
included**

12 V	10 Ah	
max. 0.62 MPa	0.2-0.45 MPa	16 L
7m	LIQUID ≥ 5 L/min	8 m
1.5 m	9.00 kg	COLOR BOX

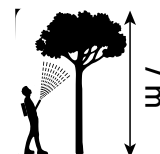
**CAPACITY 16 L**

Art.No	gross weight	in cartoon	barcode
098103	9.880 kg		3800972009233

## KNAPSACK MIST DUSTER

[BG] Моторна пръскачка • [RO] Atomizor cu motor pe benzina • [SR] Prskalica ledna motorna • [MK] Пумна прскалка на бензин • [RU] Рюкзак опрыскиватель • [SL] Motorno škropilnico • [EL] Ψεκαστήρας μηχανοκίνητος • [HR] Motorna prskalica • [FR] Pulvérisateur à dos • [IT] Spruzzatore a zaino • [ES] Pulverizador mochila • [PT] Pulverizador manual

**RD-KMD01J**

41.5 cm <sup>3</sup>	2200 W	8000 min <sup>-1</sup>
ml 2000	13.8m <sup>3</sup> /min	20 L
5m	12m	<b>FUEL / OIL 25:1</b>
LIQUID ≥ 4 L/min	DUST ≥ 6 L/min	12 kg
		COLOR BOX

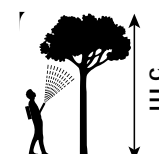
**CAPACITY 20 L**

Art.No	gross weight	barcode
110108	13.600 kg	3800123158292

**RD-KMD02**

41.5 cm <sup>3</sup>	2200 W	8000 min <sup>-1</sup>
ml 2000	13.8m <sup>3</sup> /min	14 L
10m	12m	<b>FUEL / OIL 25:1</b>
LIQUID ≥ 4 L/min	DUST ≥ 6 L/min	11 kg
		COLOR BOX

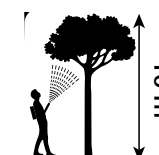
**CAPACITY 14 L**

Art.No	gross weight	in cartoon	barcode
098101	13.000 kg		3800123174254

# PERIPHERAL PUMP

[BG] Помпа водна • [RO] Pompa de apa • [SR] Pumpa • [MK] Водна пумпа • [RU] Насос • [SL] Črpalka za vodo  
[EL] Αντλία νερού • [HR] Pumpa za vodu • [FR] Pompe • [IT] Pompa • [ES] Bombo • [PT] Bomba periférica



L/min  
35 - 070101  
40 - 070115



Hmax  
35 m



Smax  
8 m

Art.No	W	L/min	gross weight	in carton	barcode
070101 RD-PK60	370	35	4.520 kg	6 pcs	3800123123887
070115 RD-WP60	500	40	5.170 kg	6 pcs	3800123141539

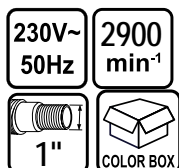

L/min  
96 - 070104  
120 - 070116



Hmax  
28 m - 070104  
35 m - 070116



Smax  
8 m - 070104  
9 m - 070116

Art.No	W	L/min	H max	S max	gross weight	in carton	barcode
070104 RD-CPM158	750	96	28	8	11.800 kg	2 pcs	3800123123481
070116 RD-WP158	850	120	35	9	12.400 kg	2 pcs	3800123141881

## RD-1.5DK20

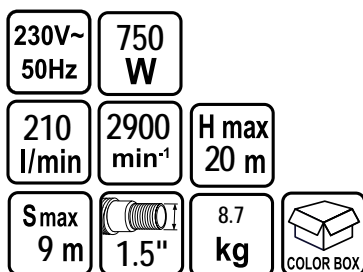

L/min  
210



Hmax  
20 m



Smax  
9 m

Art.No	gross weight	barcode
070103	9.760 kg	3800123123511

## CENTRIFUGAL PUMP RD-2DK20

[BG] Помпа водна • [RO] Pompa de apa • [SR] Pumpa • [MK] Водна пумпа • [RU] Насос • [SL] Črpalka za vodo [EL] Αντλία νερού  
• [HR] Pumpa za vodu • [FR] Pompe • [IT] Pompa • [ES] Bombo • [PT] Bomba periférica

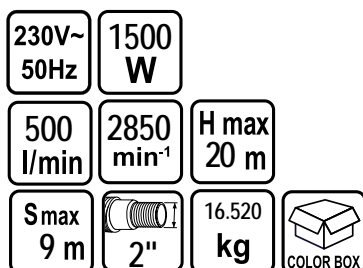

L/min  
500



Hmax  
20 m



Smax  
9 m



Art.No	gross weight	barcode
070105	17.060 kg	3800123123528



# SELF-PRIMING PUMP

[BG] Помпа водна • [RO] Pompa de apa • [SR] Pumpa • [MK] Водна пумпа • [RU] Насос • [SL] Črpalka za vodo [EL] Αντλία νερού • [HR] Pumpa za vodu • [FR] Pompe • [IT] Pompa • [ES] Bombo • [PT] Bomba periférica

## RD-JET100

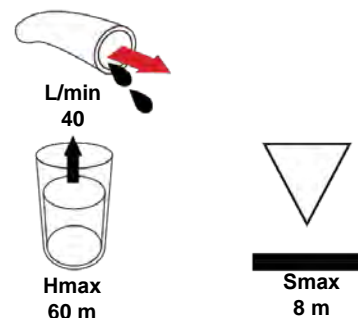

230V~ 50Hz	1100 W	
40 l/min	2850 min <sup>-1</sup>	H max 60 m
Smax 8 m	 1"	13.700 kg 



Art.No	gross weight	barcode
070117	14.100 kg	3800123115875

## RD-WP43





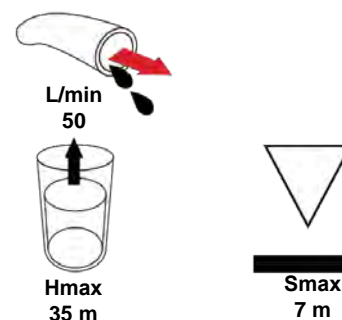

**NEW PRODUCT**

230V~ 50Hz	600 W	
50 l/min	2850 min <sup>-1</sup>	H max 35 m
Smax 7 m	 1"	6.000 kg 



Art.No	gross weight	barcode
070151	6.400 kg	3800972015753

## RDP-WP29



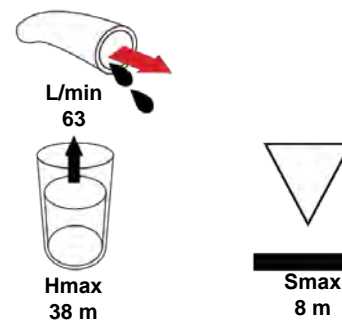



 230V~ 50Hz	63 l/min	
 650W	H max 38 m	
 2850 min <sup>-1</sup>	 1"	
Smax 8 m	 4.850 kg	
 1 m		



Art.No	gross weight	barcode
070136	5.200 kg	3800123166204

**RAIDER® Pro**

## RDP-WP44

 230V~ 50Hz	50 l/min	
 600W	H max 35 m	
 2850 min <sup>-1</sup>	 1"	
Smax 7 m	 7.250 kg	
 1 m		

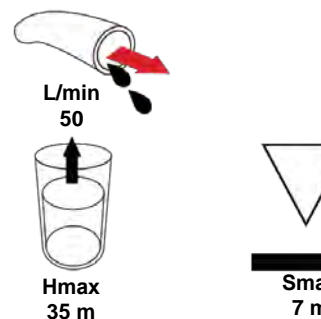



Art.No	gross weight	barcode
070152	6.900 kg	3800972015760

**RAIDER® Pro**

# SUBMERSIBLE PUMP FOR CLEAN WATER

[BG] Помпа водна потопяема за чиста вода • [RO] Pompa submersibila pentru apa curata • [SR] Pumpa potarajuća • [MK] Потопна пумпа • [RU] Насос Погружной • [SL] Potopna črpalka za vodo • [EL] Υποβρύχια αντλία νερού • [HR] Potopna pumpa za čistu vodu • [FR] Pompe submersible • [IT] Pompa sommergibile • [ES] Sumergible pumpilo • [PT] Bomba submersível

## RD-WP18

230V~ 50Hz	300 W		
18 l/min	2900 min <sup>-1</sup>	H max 60 m	
DP max 7 m	 3/4"	3.950 kg	



L/min  
18





Hmax  
60 m



DPmax  
7 m

Art.No	gross weight	in cartoon	barcode
070121	4.310 kg	6 pcs	3800123161421

## RD-WP19

230V~ 50Hz	350 W		
18 l/min	2900 min <sup>-1</sup>	H max 60 m	
DP max 7 m	 3/4"	3.950 kg	



L/min  
18





Hmax  
60 m



DPmax  
7 m

Art.No	gross weight	in cartoon	barcode
070122	4.430 kg	6 pcs	3800123161438

## RD-WP37

230V~ 50Hz	350 W		
50 l/min	2900 min <sup>-1</sup>	H max 10 m	DP max 7 m
 3/4"	 10m	4.800 kg	

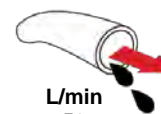

L/min  
50



Hmax  
10 m



DPmax  
7 m

Art.No	gross weight	in cartoon	barcode
070144	5.130 kg	4 pcs	3800123174605

## SUBMERSIBLE PUMP FOR SEWAGE WATER RD-WP002EX

[BG] Помпа водна потопяема за мръсна вода • [RO] Pompa submersibila pentru apa murdara • [SR] Pumpa potarajuća • [MK] Потопна пумпа • [RU] Насос Погружной • [SL] Potopna črpalka za vodo • [EL] Υποβρύχια αντλία νερού • [HR] Potopna pumpa za prijavu vodu • [FR] Pompe submersible pour eaux usées • [IT] Pompa sommergibile per acque reflue • [ES] Sumergible pumpilo por kloakaja akvo • [PT] Bomba submersível

230V~ 50Hz	400 W	2900 min <sup>-1</sup>	
H max 5 m	DP max 5 m	133 l/min	
 1"	6.2 kg		



FOLDABLE LEGS

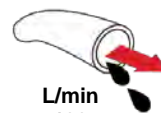

L/min  
133



Hmax  
5 m



DPmax  
5 m











Art.No	gross weight	in cartoon	barcode
070106	6.680 kg	4 pcs	3800123124037



# SUBMERSIBLE PUMP FOR SEWAGE WATER

[BG] Помпа водна потопяема за мръсна вода • [RO] Pompa submersibila pentru apa murdara • [SR] Pumpa potopajuća • [MK] Потопна пумпа • [RU] Насос Погружной • [SL] Potopna črpalka za vodo • [EL] Υποβρύχια αντλία νερού • [HR] Potopna pumpa za prljavu vodu • [FR] Pompe submersible pour eaux usées • [IT] Pompa sommergibile per acque reflue • [ES] Sumergiblea pumpilo por kloakaja akvo • [PT] Bomba submersível

## RDP-WP42

 230V~50Hz  
 400W  
 2850 min<sup>-1</sup>  
 125 l/min  
 S<sub>max</sub> 7 m  
 H<sub>max</sub> 5 m  
 15.6 kg  
 10 m  
 1"  
 COLOR BOX



**NEW PRODUCT**



L/min  
125



H max  
5 m











**RAIDER® Pro**



S max  
7 m

Art.No	gross weight	in carton	barcode
070150	15.950 kg	4 pcs	3800972015746

## RD-WP40

 230V~50Hz  
 550 W  
 166 l/min  
 H<sub>max</sub> 7 m  
 DP<sub>max</sub> 7 m  
 1"  
 max 20mm  
 10m  
 4.8 kg  
 COLOR BOX



L/min  
166











H max  
7 m



DP max  
7 m

Art.No	gross weight	in carton	barcode
070147	5.000 kg	4 pcs	3800123174636

## RD-WP12

 230V~50Hz  
 550 W  
 2900 min<sup>-1</sup>  
 175 l/min  
 H<sub>max</sub> 7 m  
 DP<sub>max</sub> 7 m  
 1"  
 5.9 kg  
 COLOR BOX

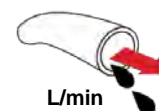

L/min  
166



H max  
7 m













INOX BODY



DP max  
7 m

Art.No	gross weight	in carton	barcode
070110	6.380 kg	4 pcs	3800123127885

## RD-WP38

 230V~50Hz  
 750 W  
 225 l/min  
 H<sub>max</sub> 7.5m  
 DP<sub>max</sub> 7 m  
 1"  
 max 15mm  
 10m  
 7.800 kg  
 COLOR BOX

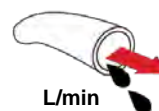

L/min  
225



H max  
7.5 m



INOX BODY



DP max  
7 m

Art.No	gross weight	in carton	barcode
070145	6.750 kg	4 pcs	3800123174612

## RD-WP39

230V~ 50Hz	1100 W
308 l/min	H max 8 m
DP max 7 m	1" max 20mm
10m	7.400 kg

COLOR BOX

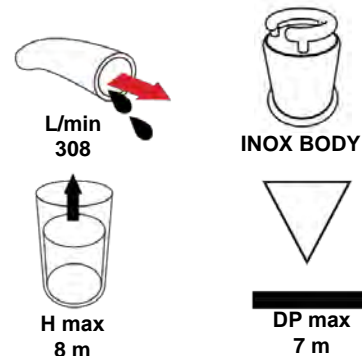

Art.No	gross weight	in carton	barcode
070146	7.750 kg	4 pcs	3800123174629

## RDP-WP28

230V~ 50Hz	400W	<p>► Sensor automatic adjustment of the pumping level</p> <p>► Manual control</p>
150 l/min	2900 min <sup>-1</sup>	
H max 5 m	DP max 5 m	
3/4"-1.1/2"	max 35mm	
10 m	4.8 kg	COLOR BOX

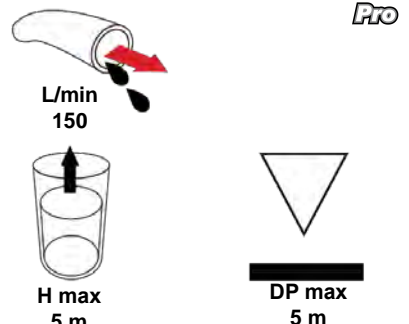

Art.No	gross weight	in carton	barcode
070135	5.250 kg	4 pcs	3800123166198

## RDP-WP25

230V~ 50Hz	750W
217 l/min	2900 min <sup>-1</sup>
H max 8 m	DP max 7 m
3/4"-1.1/2"	max 30mm
10 m	6.5 kg

COLOR BOX

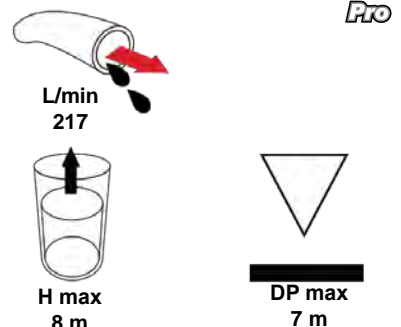

Art.No	gross weight	in carton	barcode
070132	6.750 kg	4 pcs	3800123166167

## RDP-WP26

230V~ 50Hz	900W
250 l/min	2900 min <sup>-1</sup>
H max 9.5 m	DP max 7 m
3/4"-1.1/2"	max 5mm
10 m	7 kg

COLOR BOX

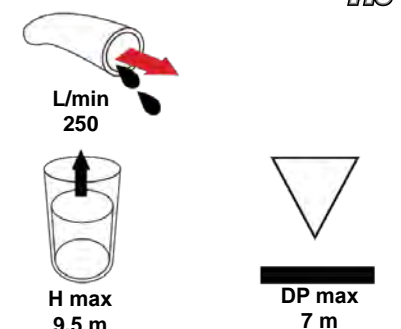

Art.No	gross weight	in carton	barcode
070133	7.300 kg	4 pcs	3800123166174



**RDP-WP27**

 230V~  
50Hz 1300W  
 417  
2900 min<sup>-1</sup> l/min  
**H max** **DP max**  
**11 m** **7 m**  
 2"  
 max 40mm  
 10 m  
 7.7 kg  
 COLOR BOX

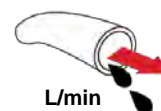

L/min  
250



H max  
9.5 m



DP max  
7 m

Art.No	gross weight	in cartoon	barcode
070134	8.630 kg	4 pcs	3800123166181

**SUBMERSIBLE PUMP FOR CLEAN WATER**

[BG] Помпа водна дълбочинна за чиста вода • [RO] Pompa submersibila pentru apa curata • [SR] Pompa potoparajuća • [MK] Потопна пумпа [RU] Насос погружной • [SL] Potopna črpalčka za vodo • [EL] Υποβρύχια αντλία νερού • [HR] Potopna pumpa za čistu vodu • [FR] Pompe submersible pour l'eau propre • [IT] Pompa sommergibile per acqua pulita • [ES] Sumergebla pumpilo por pura akvo • [PT] Bomba submersivel

**RD-WP41**

**230V~** **750**  
**50Hz** **W**  
**40** **H max**  
**l/min** **60 m**  
 1"  15m  
**9.00**   
**kg** **COLOR BOX**

CONTROL BOARD



INOX BODY

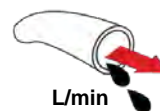







L/min  
40



H max  
60 m

Art.No	gross weight	in cartoon	barcode
070148	12.880 kg		3800123174711

**RD-WP31**

**230V~** **700**  
**50Hz** **W**  
**2900** **65** **H max**  
**min<sup>-1</sup>** **l/min** **45 m**  
 impreter X6  1.1/4"  20 m  
 22m  11.00   
**kg** **COLOR BOX**

STAINLESS STEEL BODY  
CONTROL BOARD



INOX BODY

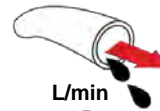



L/min  
65



H max  
45 m

Art.No	gross weight	in cartoon	barcode
070138	14.010 kg		3800123166716

## RD-WP24

230V~ 50Hz	1100 W
2900 min <sup>-1</sup>	80 l/min
H max 91 m	
 Impeller X14	 1.1/4"
 20 m	
 22 m	18.00 kg
	 COLOR BOX

STAINLESS STEEL BODY  
CONTROL BOARD



INOX BODY

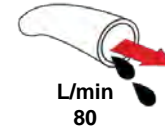

L/min  
80





H max  
91 m

Art.No	gross weight	in cartoon	barcode
070131	20.410 kg		3800123164590

## ELECTRONIC BOOSTER PUMP RD-WP17

[BG] Помпа с електронен пресостат • [RO] Pompa de apa • [SR] Pumpa • [MK] Водна пумпа • [RU] Насос • [SL] črpalka za vodo • [EL] αντλία νερού • [HR] Pumpa sa elektroničke regulator tlaka • [FR] Pompe de surpression électronique • [IT] Pompa booster elettronica • [ES] Elektronika pumpilo • [PT] Bomba elétrica

230V~ 50Hz	1200 W
3 bar	64 l/min
H max 48 m	Smax 7 m
 1"	8.300 kg
	 COLOR BOX



L/min  
64



H max  
9.5 m



INOX BODY



S max  
7 m







Art.No	gross weight	in cartoon	barcode
070119	9.500 kg		3800123158353

## SELF PRIMING PUMP WITH WATER FILTER AND LCD DISPLAY RDP-WP45

[BG] Помпа водна с воден филтър и LCD дисплей • [RO] Pompa cu autoamorsare • [SR] Pumpa sa filterom za vodu i LCD displejem • [MK] Водна пумпа со филтер за вода и LCD дисплеј • [RU] Насос с водяным фильтром и LCD-дисплеем • [SL] Črpalka za vodo z vodnim filtrom in LCD zaslonom • [EL] Αντλία νερού • [HR] Pumpa za vodu • [FR] Pompe centrifuge • [IT] Pompa centrifuga • [ES] Centrifugaj pumpoj • [PT] Bomba

WITH ELECTRONIC  
BOOSTER



 230V~ 50Hz	 1100W	 2850 min <sup>-1</sup>
77 l/min	H max 45 m	Smax 7 m
 1"	 1 m	 10.250 kg
		 COLOR BOX



L/min  
77



H max  
45 m

**RAIDER<sup>®</sup>**  
Pro

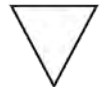

S max  
7 m

Art.No	gross weight	in cartoon	barcode
070153	11.130 kg		3800972015791

RAIDER MACHINES R20 SYSTEM PNEUMATICS ACCESSORIES







## FOUNTAIN PUMP

[BG] Помпа водна фонтан • [RO] Pompa fantana arteziana • [SR] Pumpa za fontanu • [MK] Пумпа за фонтану • [RU] Фонтанный насос • [SL] Črpalka za vodnjake • [EL] Αντλία σιντριβανιού • [HR] Pumpa za fontane • [FR] Pompe de fontaine • [IT] Pompa per fontana • [ES] Fonta pumpilo • [PT] Bomba de água

### RD-WP35

230V~ 50Hz	28 W
20 l/min	H max 1.6m
Smax 3 m	 1/2"
 10m	1.600 kg
 COLOR BOX	

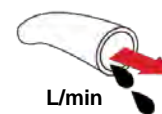

L/min  
20





H max  
1.6 m



S max  
3 m

Art.No	gross weight	in cartoon	barcode
070142	1.720 kg	12 pcs	3800123174582

### RD-WP21

230V~ 50Hz	50 W
33 l/min	H max 3 m
Smax 2.5m	 1"
 10m	1.700 kg
 COLOR BOX	



L/min  
33





H max  
3 m



S max  
2.5 m

Art.No	gross weight	in cartoon	barcode
070124	2.010 kg	8 pcs	3800123161452

### RD-WP36

230V~ 50Hz	75 W
43 l/min	H max 2.6m
Smax 3 m	 1"
 10m	3.100 kg
 COLOR BOX	

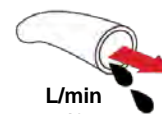

L/min  
43



H max  
2.6m



S max  
3 m

Art.No	gross weight	in cartoon	barcode
070143	3.430 kg	6 pcs	3800123174599

## AUTOMATIC PUMP CONTROLLER RD-EPC02

[BG] Пресостат електронен • [RO] Dispozitiv de comanda electronic • [SR] Kontroler pumpe • [MK] Автоматски контролер на пумпа • [RU] Реле давления воды • [SL] Elektronsko tlačno stikalo • [EL] Ηλεκτρονικός Ελεγκτής Πίεσης Αντλιών • [HR] Tlačna sklopka, elektronička • [FR] Contrôleur de pompe automatique • [IT] Regolatore automatico della pompa • [ES] Automata bomba regulo • [PT] Controlador de bomba automático

230V~ 50Hz	
2200 W	
Pmax 1 MPa	
0.900 kg	 COLOR BOX



MANOMETER



Art.No	gross weight	in cartoon	barcode
070127	1.120 kg	12 pcs	3800123161483

# BOOSTER PUMP WITH PRESSURE TANK

[BG] Хидрофор • [RO] Hidrofor • [SR] Hidropak • [MK] Хидрофор • [RU] Гидрофор • [SL] Ohišje črpalke in tlačna posoda • [EL] Μονάδα αντλίας πίεσης • [HR] Hidropak za vodu • [FR] Pompe de surpression avec réservoir sous pression • [IT] Pompa di aumento pressione con serbatoio a pressione • [ES] Akcelilo kun premotanko • [PT] Bomba de reforço e tanque

## RD-WP800S

**NEW  
PRODUCT**

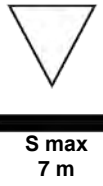

230V~ 50Hz	800 W	53 l/min
3 bar	H max 40 m	S max 7 m
 1"	10.790 kg	 COLOR BOX



Art.No	gross weight	in cartoon	barcode
071106	11.350 kg		3800972015784

## RDP-WP800SW

**NEW  
PRODUCT**



230V~ 50Hz	800 W	53 l/min
3 bar	H max 40 m	S max 7 m
 1"	12.100 kg	 COLOR BOX



Art.No	gross weight	barcode
071105	12.600 kg	3800972015777

## RD-WP1200S

**NEW  
PRODUCT**



230V~ 50Hz	1200 W	64 l/min
3 bar	H max 48 m	S max 7 m
 1"	11.790 kg	 COLOR BOX



Art.No	gross weight	barcode
071107	12.350 kg	3800972017986

## RD-WP1300S

**NEW  
PRODUCT**

230V~ 50Hz	1300 W	80 l/min
3 bar	H max 48 m	S max 8 m
 1"	12.590 kg	 COLOR BOX



Art.No	gross weight	barcode
071108	13.000 kg	3800972017993



**RD-WP1200J**

230V~ 50Hz	1200 W	64 l/min
3 bar	H max 48 m	S max 7 m
1"	13.500 kg	COLOR BOX

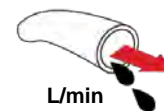
**L/min**  
64

**H max**  
48 m

**S max**  
7 m

Art.No	gross weight	in cartoon	barcode
071104	14.000 kg		3800123158360

**RD-WP1300**

230V~ 50Hz	1300 W	75 l/min
3 bar	H max 48 m	S max 8 m
1"	18.000 kg	COLOR BOX

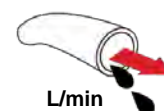
**L/min**  
75

**H max**  
48 m

**S max**  
8 m

Art.No	gross weight	in cartoon	barcode
070125	18.500 kg		3800123161469

**GASOLINE WATER PUMP**

[BG] Помпа водна бензинова • [RO] Motorpompa cu motor pe benzina • [SR] Pumpa za navodnjavanje motorna • [MK] Пумпа за вода на бензин • [RU] Мотопомпа бензиновая • [SL] Bencinska vodna črpalka • [EL] Βενζινοκίνητη αντλία νερού • [HR] Motorna crpka za vodu • [FR] Pompe à eau essence • [IT] Pompa ad acqua benzina • [ES] Bombo por benzino • [PT] Bomba de água a gasolina

**RD-GWP02J**

• Двигател: Едноцилиндров, бензинов, двутактов с въздушно охлаждане  
• Engine type: Air cooling, single cylinder, two stroke

25.4 cm <sup>3</sup>	8300 W	133 l/min
H max 17.5m	6 500 min <sup>-1</sup>	FUEL / OIL 25:1
S max 8 m	1"	0.7
ml 700	8.050 kg	COLOR BOX

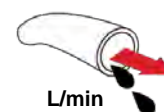
**L/min**  
133

**H max**  
17.5 m

**S max**  
8 m

Art.No	gross weight	in cartoon	barcode
079908	8.600 kg		3800123158407

## RD-GWP03J

- Двигател: Едноцилиндров, бензинов, двутактов с въздушно охлаждане
- Engine type: Air cooling, single cylinder, two stroke

 42.7 cm <sup>3</sup>	<b>1250 W</b>	<b>250 l/min</b>
<b>H max 35 m</b>	<b>6 500 min<sup>-1</sup></b>	<b>FUEL / OIL 25:1</b>
<b>S max 8 m</b>	 1.5"	 1/h
 ml 1500	 5.550 kg	 COLOR BOX



L/min  
250



H max  
35 m







S max  
8 m

Art.No	gross weight	in cartoon	barcode
092101	6.000 kg		3800123161315

## RD-GWP01

- Двигател: Едноцилиндров, бензинов, четиритактов с въздушно охлаждане
- Engine type: Air cooling, single cylinder, four stroke

 196 cm <sup>3</sup>	<b>4100 W</b>	
<b>550 l/min</b>	<b>H max 26 m</b>	<b>3 600 min<sup>-1</sup></b>
<b>S max 8 m</b>	 2"	 ml 600
 ml 3800	 22.100 kg	 COLOR BOX



L/min  
550



H max  
35 m









S max  
8 m

Art.No	gross weight	in cartoon	barcode
079906	23.000 kg		3800123112980

## RD-GWP04

**NEW PRODUCT**

- Двигател: Едноцилиндров, бензинов, четиритактов с въздушно охлаждане
- Engine type: Air cooling, single cylinder, four stroke

 196 cm <sup>3</sup>	<b>4900 W</b>	
<b>933 l/min</b>	<b>H max 30 m</b>	<b>3 600 min<sup>-1</sup></b>
<b>S max 8 m</b>	 3"	 0.6
 ml 3800	 22.700 kg	 COLOR BOX



L/min  
933



H max  
30 m



S max  
8 m

Art.No	gross weight	barcode
070149	24.000 kg	3800972003569



**GASOLINE HIGH PRESSURE CLEANER RD-GHPC06**

[BG] Водоструйка бензинова • [RO] Aparat de spalat cu presiune cu motor pe benzina • [SR] Benzin visokotlačni čistač • [MK] Бензин машина за перење под висок притисок • [RU] Бензиновая мойка высокого давления • [SL] Bencin visokotlačni čistilec • [EL] Πλυντικό υψηλής πίεσης • [HR] Visokotlačni čistač motorni • [FR] Nettoyeur haute pression essence • [IT] Idropulitrice a benzina • [ES] Limpiador de alta presión de gasolina • [PT] Lavadora a gasolina

**NEW  
PRODUCT**

**5200  
W**
**208 cm³**
**P<sub>max</sub>  
20  
MPa**
**3 600  
min<sup>-1</sup>**
**ml  
600**
**max  
10  
l/min**
**S<sub>max</sub>  
1 m**
**2.0  
l/kWh**
**ml  
3600**
**30.00  
kg**
**COLOR BOX**

Art.No	gross weight	barcode
072104	34.000 kg	3800972010673





# HIGH PRESSURE CLEANER

[BG] Водоструйка • [RO] Aparat de spalat cu presiune • [SR] Perač pod pritiskom • [MK] Машина за перење под висок притисок • [RU] Мойка высокого давления • [SL] Visokotlačni čistilec • [EL] Πλυντικό υψηλής πίεσης • [HR] Visokotlačni čistač • [FR] Nettoyeur haute pression • [IT] Pulitore ad alta pressione • [ES] Alta premo • [PT] Lavadora

## RD-HPC05

**NEW  
PRODUCT**

230V~ 50Hz	1400 W
P <sub>max</sub> 12 MPa	6 l/min
6.400 kg	 COLOR BOX

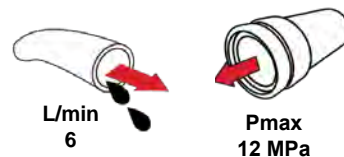

Art.No	gross weight	in carton	barcode
072103	7.300 kg		3800972009172

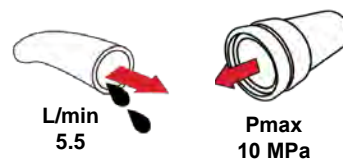

## RD-HPC01

230V~ 50Hz	1400 W
P <sub>max</sub> 10 MPa	5.5 l/min
5.700 kg	 COLOR BOX



Art.No	gross weight	in carton	barcode
123201	6.400 kg		3800123115554

## RD-HPC02

230V~ 50Hz	1800 W
P <sub>max</sub> 14 MPa	6.7 l/min
 8.900 kg	 COLOR BOX

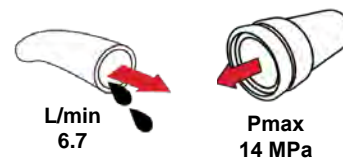

Art.No	gross weight	in carton	barcode
123202	10.060 kg		3800123140938



**RD-HPC07**

**NEW  
PRODUCT**

230V~ 50Hz	2200 W
P <sub>max</sub> 17 MPa	7.5 l/min
8.200 kg	 COLOR BOX

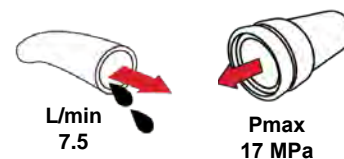

Art.No	gross weight	in cartoon	barcode
072105	9.500 kg	1pcs	3800972015982

**RD-HPC08**

**NEW  
PRODUCT**

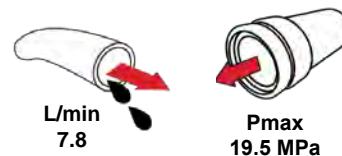

230V~ 50Hz	2500 W
P <sub>max</sub> 19.5 MPa	7.8 l/min
8.600 kg	 COLOR BOX



Art.No	gross weight	in cartoon	barcode
072106	9.800 kg	1pcs	3800972015999

**AUTOMATIC CABLE REEL WATERPROOF**

[BG] Удължител на автоматична макара влагоустойчива • [RO] Prelungitor pe tambur rezistent la umiditate • [SR] Automatski proizužetak bubnja • [MK] Автоматско продолжување на ролна • [RU] Автоматический удлинитель барабана влагостойкий • [SL] Samodejni odtegovalnik koluta odporen na vlago • [EL] Αυτόματη επεκτάσιμη επένδυση με μπομπίνα • [HR] Automatski proizužnik bubnja • [FR] Extendeur automatique de bobine résistant à l'humidité • [IT] Estensione bobina automatica resistente all'umidità • [ES] Automata reel-etenda humideco • [PT] Extensor de bobina automático resistente à umidade

250 V	 20m
 3x1.5mm <sup>2</sup>	 COLOR BOX



Art.No	gross weight	in cartoon	barcode
070128	3.500 kg		38001231611490



## ELECTRIC INDUSTRIAL FAN HEATER

[BG] Калорифер електрически • [RO] Incalzitor electric • [SR] Električni grejač • [MK] Калорифер електрични [RU] Электрический нагреватель • [SL] Električni grelec zraka • [EL] Ηλεκτρική θερμάστρα • [HR] Električni grijač • [FR] Aérotherme industriel électrique • [IT] Termoventilatore elettrico industriale • [ES] Elektra industria ventumilo • [PT] Aquecedor elétrico industrial

### RD-EFH02

230V~ 50Hz	2000 W
100m³/h	25/1000/2000W
L: 23cm W: 22cm H: 31.5cm	20m³
3.600 kg	COLOR BOX



HEATING AREA  
20 m³

Art.No	gross weight	barcode
078801	4.000 kg	3800123167874

### RD-EFH03

230V~ 50Hz	3000 W
150m³/h	25/1000/2000W
L: 25.4cm W: 25cm H: 31.5cm	30m³
4.400 kg	COLOR BOX



HEATING AREA  
30 m³

Art.No	gross weight	barcode
078806	4.900 kg	3800123167911

### RD-EFH3.3

230V~ 50Hz	3300 W
150m³/h	30/1500/3000W
L: 27 cm W: 25.5cm H: 40 cm	30m³
4.800 kg	COLOR BOX





HEATING AREA  
30 m³

Art.No	gross weight	barcode
123303	5.500 kg	3800123133886





**RD-EFH05**

400V~ 50Hz	5000 W
 200m³/h	 45/2500/5000W
L: 27cm W: 25.5cm H: 40cm	50m³
4.900 kg	 COLOR BOX

**HEATING AREA**  
50 m³

Art.No	gross weight	barcode
078803	5.700 kg	3800123167881

**RD-EFH09**

400V~ 50Hz	9000 W
 300m³/h	 55/4500/9000W
L: 35cm W: 35cm H: 50.5cm	80m³
9.500 kg	 COLOR BOX

**HEATING AREA**  
80 m³

Art.No	gross weight	barcode
078804	10.400 kg	3800123167898

**RD-EFH15**

400V~ 50Hz	15000 W
 400m³/h	 65/7500/15000W
L: 46cm W: 39cm H: 59cm	120m³
16.400 kg	 COLOR BOX



**HEATING AREA**  
120 m³

Art.No	gross weight	barcode
078805	17.400 kg	3800123167904

**GAS HEATER**

[BG] Калорифер на газ • [RO] Aeroterma • [SR] Grejač gasni • [MK] Калорифер на гас • [RU] Подогреватель газа пропана • [SL] Plinov Grelnik • [EL] Θερμίστρα αερίου • [HR] Plinski grijač • [FR] Chauffe-gaz • [IT] Stufa a gas • [ES] Gas-heitilo • [PT] Aquecedor a gas

**RD-GH15**

230V~ 50Hz	15000 W
 300m³/h	116m³
L: 47.3cm W: 20.7cm H: 32.2cm	4.600 kg
 COLOR BOX	

**HEATING AREA**  
116 m³

Art.No	gross weight	barcode
129973	5.200 kg	3800123101809

## RD-GH40

230V~ 50Hz	40000 W
750m³/h	310m³
L: 57.2cm W: 22.5cm H: 37.4cm	6.400 kg
	COLOR BOX



HEATING AREA  
310 m³

Art.No	gross weight	in cartoon	barcode
450201	7.100 kg		3800123167928

## DIESEL SPACE HEATER RD-DSH50

[BG] Капорифер нафтов • [RO] Generator aer cald ardere directa diesel • [SR] Grejač Nafta • [MK] Капорифер нафтов • [RU] Тепловая пушка • [SL] Premični grelnik zraka • [EL] Αεροθερμο Πετρελαιοιου • [HR] Dizelski grijač • [FR] Chauffage spatial diesel • [IT] Riscaldatore di spazio diesel • [ES] Diesel a heating • [PT] Aquecedor a diesel

230V~ 50Hz	50 kW
800m³/h	400m³
L: 110cm W: 48cm H: 50cm	28.900 kg
	COLOR BOX



HEATING AREA  
400 m³

Art.No	gross weight	in cartoon	barcode
123304	31.500 kg		3800123133893

## HANDLE MIXER

[BG] Миксер • [RO] Amestecator • [SR] Mešač • [MK] Рачна Мешалка • [RU] Перемешиватель • [SL] Mešalnik • [EL] Δραπάνο Αναδευτήρας • [HR] Miješalica • [FR] Mélangeur à poignée • [IT] Maneggiare il mixer • [ES] Manlibro miksažo • [PT] Misturadora manual

### RD-HM07

230V~ 50Hz	1200 W	0-600 min <sup>-1</sup>
M14x2mm	Ø120/590 mm	max 40L
	3.900 kg	COLOR BOX

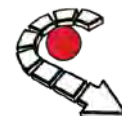

VARIABLE SPEED



M14x2 mm



ERGONOMICAL  
HANDLE

Art.No	gross weight	in cartoon	barcode
078508	4.400 kg	4 pcs	3800972009219

### RD-HM06

230V~ 50Hz	1200 W	0-680 min <sup>-1</sup>
M14x2mm	Ø120/590 mm	max 40L
	4.350 kg	COLOR BOX



VARIABLE SPEED



M14x2 mm



ERGONOMICAL  
HANDLE

Art.No	gross weight	in cartoon	barcode
078507	4.000 kg	2 pcs	3800972008700



**RD-HM05**

230V~ 50Hz	850 W
0-550 min <sup>-1</sup>	10 mm
16 mm	13 mm
	3.900 kg

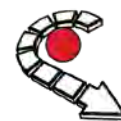

VARIABLE SPEED



HIGH TORQUE



TWO FUNCTION

Art.No	gross weight	in carton	barcode
078503	4.540 kg	4 pcs	3800123133732

**RD-HM02**

230V~ 50Hz	850 W
0-500 min <sup>-1</sup>	∅120/590 mm
	3.900 kg

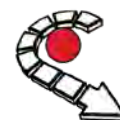

VARIABLE SPEED

Art.No	gross weight	in carton	barcode
129999	5.000 kg	4 pcs	3800123133732

**RD-HM08**

230V~ 50Hz	1400 W	200-700 min <sup>-1</sup>
M14x2mm	∅120/590 mm	max 40L
		5.030 kg
LED		



M14x2 mm

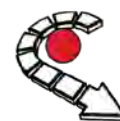

VARIABLE SPEED



LED



ERGONOMICAL  
HANDLE

Art.No	gross weight	in carton	barcode
078509	6.000 kg	4 pcs	3800972009158

**RDP-HM03**

	230V~ 50Hz
	1400W
	2x GEARS
	1' 180-460 min <sup>-1</sup> 2' 300-700 min <sup>-1</sup>
	5.679 kg



**RAIDER®**  
*Pro*



VARIABLE SPEED



TWO GEARS

Art.No	gross weight	in carton	barcode
078501	6.310 kg	2 pcs	3800123166860



### RDP-HM10

**NEW  
PRODUCT**

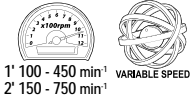
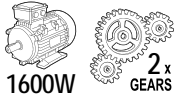

**RAIDER<sup>®</sup>  
Pro**



VARIABLE SPEED



TWO GEARS

Art.No	gross weight	barcode
078602	6.900 kg	380097208020

### HANDLE MIXER WITH TWO PADDLES RDP-HM09

[BG] Миксер с две бъркалки • [RO] Amestecator cu două palete • [SR] Mešač sa dve lopatice • [MK] Рачна Мешалка со две лостови • [RU] Перемешиватель с двумя лопастями • [SL] Mešalnik z dvema ročicama • [EL] Δραπάνο Αναδευτήρας • [HR] Miješalica s dvije lopatice • [FR] Mélangeur à deux palettes • [IT] Maneggiare il mixer con due paddle • [ES] Uzu miksaĵon kun du pakajoj • [PT] Misturadora manual com duas pás

**NEW  
PRODUCT**

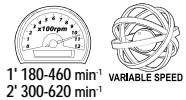
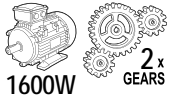

**RAIDER<sup>®</sup>  
Pro**



VARIABLE SPEED



TWO PADDLES



TWO GEARS

Art.No	gross weight	in carton	barcode
078601	8.900 kg	2 pcs	3800972010758





## TILE CUTTING MACHINE

[BG] Машина за плочки • [RO] Dispozitiv pt taiat placi • [SR] Mašina za sečenje pločica • [MK] Машина за сечење на плочки [RU] Машина для резки плитки • [SL] Rezalnik za keramične ploščice • [EL] Κόφτης πλακιδίων χειρός • [HR] Rezač ručni za keramičke pločice • [FR] Machine à couper les carreaux • [IT] Tagliapiastrelle • [ES] Kahela mašino • [PT] Máquina de corte de cerâmica

### RD-TC02



1.490  
kg



Art.No	gross weight	in cartoon	barcode
321501	1.700 kg	6 pcs	3800123116308

### RD-TC03



3.610  
kg



Art.No	gross weight	in cartoon	barcode
321511	3.980 kg	6 pcs	3800123116483



Art.No	Size	Weight	gross weight	in cartoon	barcode
321502 RD-TC10	400	4.800	4.820 kg	4 pcs	3800123116322
321507 RD-TC12	500	5.240	5.270 kg	4 pcs	3800123116315
321503 RD-TC13	600	5.700	5.880 kg	4 pcs	3800123116339

### RD-TC11



7.700  
kg



Art.No	gross weight	in cartoon	barcode
321510	7.750 kg	4 pcs	3800123116292

### RD-TC14

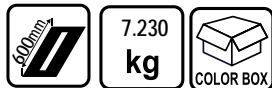

Art.No	gross weight	in cartoon	barcode
321514	7.350 kg	2 pcs	3800123150425

### RD-TC16

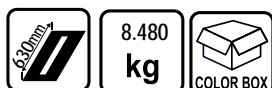

Art.No	gross weight	in cartoon	barcode
321509	8.500 kg		3800123116452

### RD-TC31

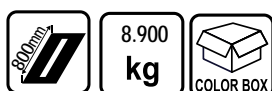

Art.No	gross weight	in cartoon	barcode
321522	9.000 kg	2 pcs	3800972008953

### RD-TC18

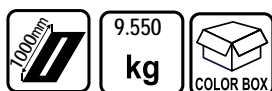

Art.No	gross weight	in cartoon	barcode
321515	10.230 kg	2 pcs	3800123150418

### RD-ETC25

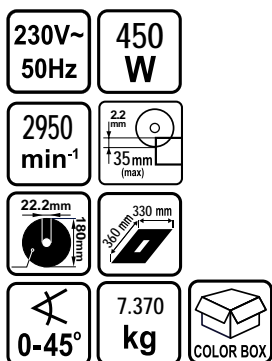

Art.No	gross weight	in cartoon	barcode
129991	10.500 kg		3800123131486



**RD-ETC20**

230V~ 50Hz	600 W
2800 min <sup>-1</sup>	35 mm (max)
22.2mm 180mm	395 mm
0-45°	10.400 kg
	COLOR BOX



**ADJUSTABLE  
CUTTING DEPTH  
AND CUTTING ANGLE 45°**

Art.No	gross weight	barcode
129908	11.500 kg	3800123124495

**RD-ETC23**

**Motor: Асинхронен електрически двигател със защита от претоварване.  
Motor: Asynchronous electric motor with overload protection.**



Foldable legs for quick assembling and easy transportation

230V~ 50Hz	800 W
2950 min <sup>-1</sup>	0.79 m
385 mm	35 mm (max)
25.4mm 200mm	480 mm (max)
0-45°	25.00 kg



BEVEL CUT 0-45°



PROTRACTOR FOR CROSS CUTTING ANGLE



**ADJUSTABLE  
CUTTING DEPTH  
AND CUTTING ANGLE 45°**

Art.No	gross weight	in carton	barcode
129937	27.000 kg	1 pcs	3800123123061

**RDP-ETC27**

230V~ 50Hz	800W
22.2mm	45°
22 mm	440 mm
5600 min <sup>-1</sup>	620 mm (max)
40 mm	32.40 kg



**RAIDER®  
Pro**

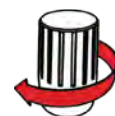

**DEPTH CONTROL**

Art.No	gross weight	barcode
078002	36.000 kg	3800123159060

### RDP-ETC30

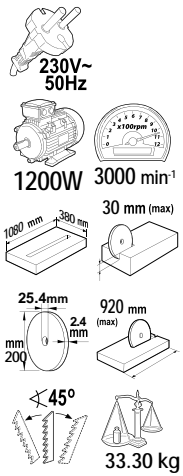

**RAIDER<sup>®</sup>**  
*Pro*



DEPTH CONTROL

Art.No	gross weight	barcode
078005	37.000 kg	3800123172199

### RDP-ETC26T

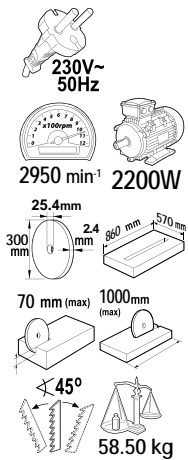

**RAIDER<sup>®</sup>**  
*Pro*



DEPTH CONTROL

Art.No	gross weight	barcode
078001	65.000 kg	3800123159053

### RDP-ETC29

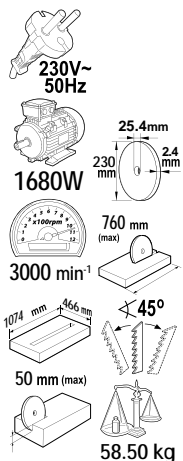

**RAIDER<sup>®</sup>**  
*Pro*



DEPTH CONTROL

Art.No	gross weight	barcode
078004	59.000 kg	3800123168468





**RAIDER®**

**RAIDER®**

R20 SYSTEM

RAIDER MACHINES

PNEUMATICS

ACCESSORIES

## METAL MINI AIR COMPRESSOR

[BG] Компресор метален с аксесоари • [RO] Mini Compresor • [SR] Kompresor zaduvanje guma • [MK] Компресорче • [RU] Компрессор для накачивания шин • [SL] Avtomobilski kompresor • [EL] Αεροσυμπιεστής • [HR] Kompresor • [FR] Compresseur de gonflage • [IT] Compresore per gonfiaggio pneumatici • [ES] Kompresoro pri švelaja inflacio • [PT] Compressor de inflação de pneus

### RD-AC05

12 V	120 W
35 L/min	P 0.96 Pa
3m	1 m
1.670 kg	COLOR BOX



Art.No	gross weight	in cartoon	barcode
089402	1.700 kg	10 pcs	3800123174537

### RD-AC13

12 V	180 W
35 L/min	P 0.96 Pa
1 m	1.600 kg
	COLOR BOX



**NEW  
PRODUCT**

Art.No	gross weight	in cartoon	barcode
089408	1.700 kg	10 pcs	3800972016397

### RD-AC14

12 V	300 W	70L/min
P 0.96 Pa	3m	
1 m	1.900 kg	COLOR BOX



**NEW  
PRODUCT**

Art.No	gross weight	in cartoon	barcode
089409	3.670 kg	6 pcs	3800972016408

# AIR COMPRESSOR

[BG] Компресор • [RO] Compresor • [SR] Kompresor • [MK] Компресор • [RU] Компрессор • [SL] Kompresor [EL] Συμπιεστής • [HR] Kompresor • [FR] Compresseur • [IT] Compresore • [ES] Kompresoro [PT] Compressor

## RD-AC040

230V~ 50Hz	1500 W
2800 min <sup>-1</sup>	P 0.8 MPa
IN 195L/min	OUT 110L/min
TANK 24 L	18.00 kg
COLOR BOX	

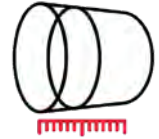

TANK CAPACITY  
24L

Art.No	gross weight	barcode
089401	19.000 kg	3800123173462

## RD-AC12

**NEW PRODUCT**

230V~ 50Hz	1500 W
2800 min <sup>-1</sup>	P 0.8 MPa
IN 195L/min	OUT 110L/min
TANK 24 L	18.00 kg
COLOR BOX	

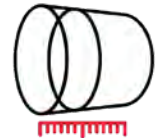

TANK CAPACITY  
24L

Art.No	gross weight	barcode
089407	19.000 kg	3800972016071

## QUIET OIL FREE AIR COMPRESSOR RD-AC07

[BG] Компресор тих безмаслен • [RO] Compresor • [SR] Kompresor • [MK] Компресор • [RU] Компрессор • [SL] Kompresor [EL] Συμπιεστής • [HR] Kompresor • [FR] Compresseur • [IT] Compresore • [ES] Kompresoro • [PT] Compressor

230V~ 50Hz	750 W
1440 min <sup>-1</sup>	P 0.8 MPa
IN 195L/min	OUT 135L/min
TANK 24 L	20.00 kg
COLOR BOX	

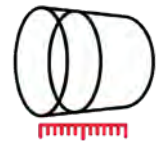

TANK CAPACITY  
24L

Art.No	gross weight	barcode
089405	21.000 kg	3800972009639



# AIR COMPRESSOR

[BG] Компресор • [RO] Compresor • [SR] Kompresor • [MK] Компресор • [RU] Компрессор • [SL] Kompresor [EL] Συμπιεστής • [HR] Kompresor • [FR] Compresseur • [IT] Compressore • [ES] Kompresoro • [PT] Compressor

## RD-AC02

230V~ 50Hz	1500 W
2800 min <sup>-1</sup>	P 0.8 MPa
IN 195L/min	OUT 110L/min
TANK 50L	24.500 kg
COLOR BOX	

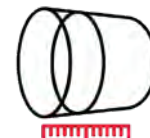

TANK CAPACITY  
50L

Art.No	gross weight	barcode
120105	25.000 kg	3800123123368

## RD-AC08

230V~ 50Hz	2200 W
2800 min <sup>-1</sup>	P 0.8 MPa
IN 195L/min	OUT 110L/min
TANK 50L	30.00 kg
COLOR BOX	

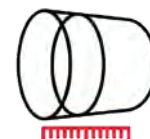

TANK CAPACITY  
50L

Art.No	gross weight	barcode
089406	32.000 kg	3800972009646

## RD-AC030

230V~ 50Hz	2200 W
2800 min <sup>-1</sup>	P 0.8 MPa
IN 370L/min	OUT 340L/min
TANK 100L	43.00 kg
COLOR BOX	

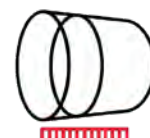

TANK CAPACITY  
100L

Art.No	gross weight	barcode
120107	45.920 kg	3800123160820

## RD-AC06

370V 50Hz	7500 W
2850 min <sup>-1</sup>	P 0.10 MPa
IN 900L/min	TANK 270L
220 kg	COLOR BOX

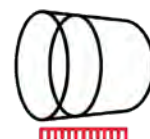

TANK CAPACITY  
270L

Art.No	gross weight	barcode
089404	220 kg	3800123174735

# **RAIDER**<sup>®</sup>

## **Pneumatic**

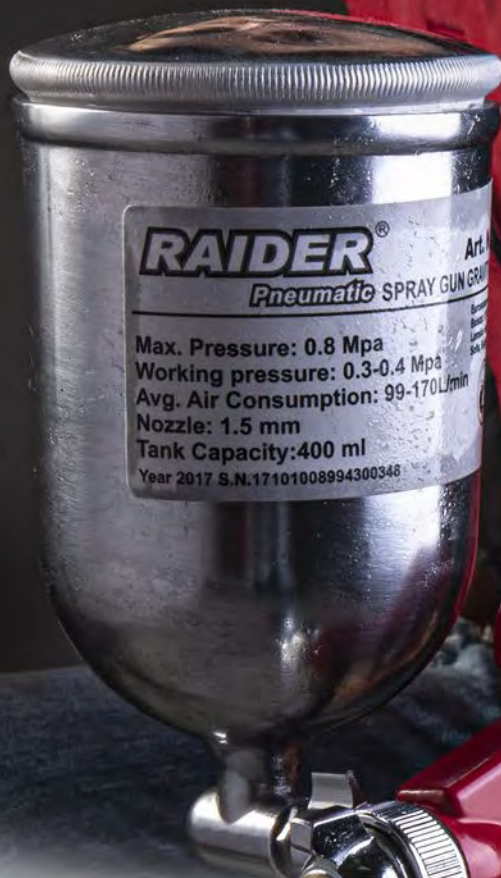

**RAIDER**<sup>®</sup>





## AIR DRILL RD-AD02

[BG] Бормашина пневматична • [RO] Masina de gaurit pneumatica • [SR] Bušilica pneumatska • [MK] Бормашина пневматска • [RU] Пневматическая Дрель • [SL] Pnevmatiskih vrtalnik • [EL] Δράπανο Αέρος [HR] Pnevmatiska Bušilica • [FR] Perceuse à air • [IT] Trapano pneumatico • [ES] Aera Drilo • [PT] Aparafusadora pneumáticas

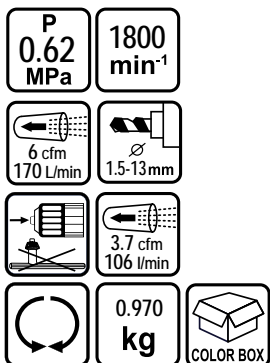

WORKING PRESSURE  
0.62 MPa

Art.No	gross weight	in cartoon	barcode
080103	1.370 kg	10 pcs	3800123123689

## AIR ANGLE GRINDER RD-AAG03

[BG] Ъглошлайф пневматичен • [RO] Polizor unghiular pneumatic • [SR] Brusilica ugaona pneumatska • [MK] Брусилка пневматска [RU] Пневматический шлифовальный станок • [SL] Pnevmatiski brusilnik • [EL] Γωνιακός αεροτροχός • [HR] Kutna brusilica • [FR] Meuleuse d'angle d'air • [IT] Air Angle Grinder • [ES] Aera Angulo Muelilo • [PT] Rebarbadora pneumáticas

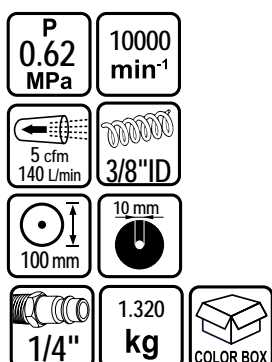

WORKING PRESSURE  
0.62 MPa

Art.No	gross weight	in cartoon	barcode
089939	1.340 kg	10 pcs	3800123153648

## AIR CUT OFF TOOL RD-AC11

[BG] Резачка пневматична • [RO] Masina de taiat pneumatica • [SR] Brusilica ugaona pneumatska • [MK] Мини брусилка пневматска [RU] Пневматическая Угловая Шлифовальная машина • [SL] Pnevmatiski Kotni Brusilnik • [EL] Γωνιακός Τροχός Αέρος • [HR] Pnevmatiska rezacića • [FR] Outil de coupure d'air • [IT] Strumento di taglio pneumatico • [ES] Aero trançita ekstere • [PT] Cortadora pneumática/ disco

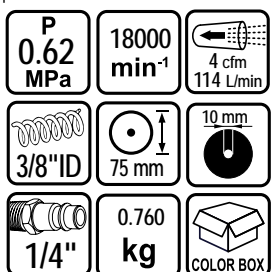

WORKING PRESSURE  
0.62 MPa

Art.No	gross weight	in cartoon	barcode
089921	1.060 kg	20 pcs	3800123122415

## AIR RANDOM ORBIT SANDER RD-AROS01

[BG] Ексцентършлайф пневматичен • [RO] Stefuiitor orbital pneumatic • [SR] Brusilica Rotaciona pneumatska • [MK] Пневматска Ексцентрична Брусилка • [RU] Пневматический Эксцентриковые шлифовальные машины • [SL] Pnevmatiskih Ekscentrični Brusilnik • [EL] Αέρος Εκκεντρο Τριβείο • [HR] Brusilica Ekscentarska • [FR] Ponceuse orbitale Air Random • [IT] Levigatrice orbitale • [ES] Orbital Sander • [PT] Lixadora orbital pneumática



WORKING PRESSURE  
0.62 MPa

Art.No	gross weight	in cartoon	barcode
089301	1.560 kg	10 pcs	3800123165375

## AIR HAMMER MINI RD-AH01

[BG] Сечак пневматичен • [RO] Dalta pneumatica • [SR] Čekić bušilica pneumatski • [MK] Ударен Чекан пневматски [RU] Пневматическое зубило • [SL] Pnevmatiko udarno dleto • [EL] Αεροσφύρα • [HR] Pneumatski Čekić • [FR] Marteau Mini • [IT] Aero Martelo • [ES] Aera martelo • [PT] Kit mini-martelo pneumático

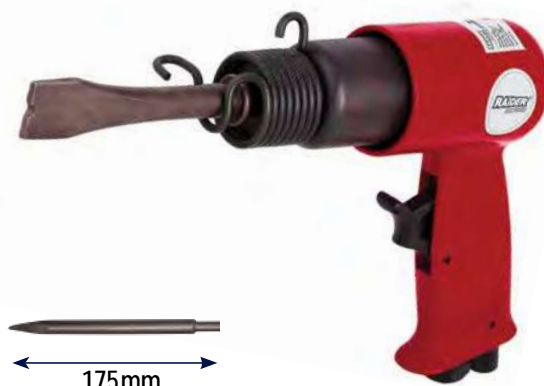
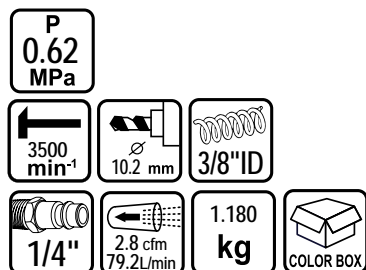

Art.No	gross weight	in cartoon	barcode
080102	1.760 kg	10 pcs	3800123123672

## AIR MICRO GRINDER RD-AMG01

[BG] Шлифовалка пневматична микро • [RO] Polizor drept pneumatic • [SR] Brusilica čeona pneumatska • [MK] Пневматска Шлајферица [RU] Шлифовальный станок мини • [SL] Zracni Mini Brusilnik • [EL] Μίνι Τροχίο αέρος • [HR] Jednoručna Brusilica Mini • [FR] Appareil à moudre • [IT] Aero molare • [ES] Muelilo • [PT] Moedor

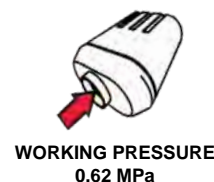
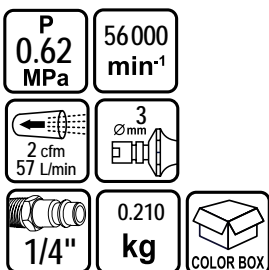

Art.No	gross weight	in cartoon	barcode
089920	0.330 kg	20 pcs	3800123123675

## AIR DIE GRINDER RD-ADG01

[BG] Шлифовалка пневматична права • [RO] Polizor drept pneumatic • [SR] Brusilica čeona pneumatska • [MK] Пневматска Шлајферица • [RU] Шлифовальный станок мини • [SL] Zracni Mini Brusilnik • [EL] Μίνι Τροχίο αέρος • [HR] Jednoručna Brusilica • [FR] Broyeur d'air • [IT] Aero Macinino • [ES] Aera Muelilo • [PT] Moedor de ar

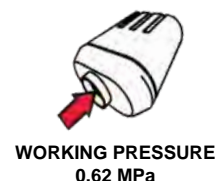
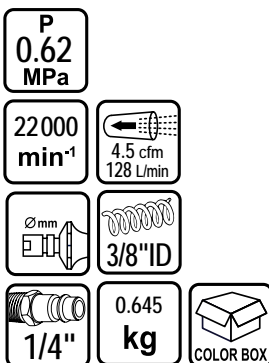

Art.No	gross weight	in cartoon	barcode
081102	0.680 kg	20 pcs	3800123123696

## AIR ANGLE DIE GRINDER RD-AADG06

[BG] Шлифовалка пневматична под прав ъгъл • [RO] Polizor drept pneumatic • [SR] Brusilica čeona pneumatska [MK] Пневматска Шлајферица • [RU] Шлифовальный станок мини • [SL] Zracni Mini Brusilnik • [EL] Μίνι Τροχίο αέρος • [HR] Jednoručna Brusilica • [FR] Meuleuse d'angle d'air • [IT] Macinino • [ES] Aera Angulo Muelilo • [PT] Rebarbadora pneumática

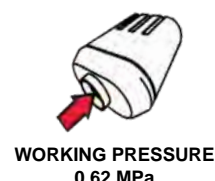
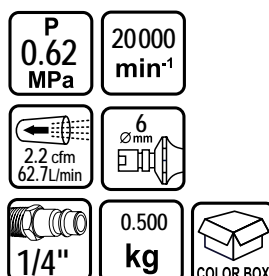

Art.No	gross weight	in cartoon	barcode
089924	0.690 kg	20 pcs	3800123122446



## AIR RATCHET WRENCH RD-AR01

[BG] Трещотка пневматична • [RO] Cheie cu clictet pneumatica • [SR] Račna Pnevmatiska • [MK] Пневматска крцкалка [RU] Трещотка пневматическая • [SL] Zračni ratchet ključem • [EL] Κατσάνια αέρος • [HR] Pnevmatiska Račna • [FR] Clé à cliquet pneumatique • [IT] Chiave a cricchetto pneumatico • [ES] Ślosilo de aera raketo • [PT] Chave de roquete pneumática

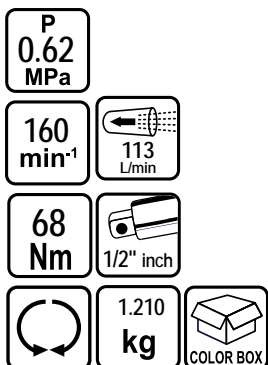

**WORKING PRESSURE**  
0.62 MPa

Art.No	gross weight	in cartoon	barcode
089905	1.360 kg	20 pcs	3800123123702

## AIR IMPACT WRENCH

[BG] Гайковерт пневматичен ударен • [RO] Cheie cu impact pneumatica • [SR] Zavrtac set pneumatski • [MK] Пневматски чекан навртувачот • [RU] Пневматический ударный ключ • [SL] Nárazový klúč • [EL] Κρουστικο κλειδί • [HR] Udarni Izvijač • [FR] Clé à chocs pneumatique • [IT] Chiave pneumatica • [ES] Aera Trançilo • [PT] Chave de impacto pneumática

### RD-AW03

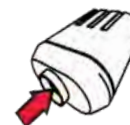
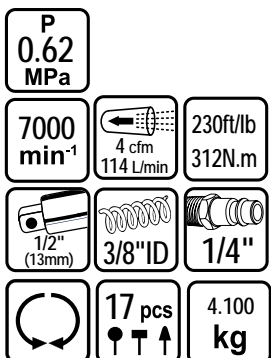

**WORKING PRESSURE**  
0.62 MPa

Art.No	gross weight	in cartoon	barcode
089922	4.390 kg	4 pcs	3800123122422

### RD-AW04

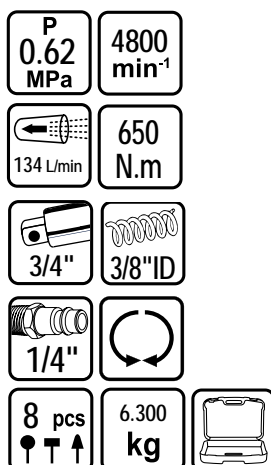

**WORKING PRESSURE**  
0.62 MPa

Art.No	gross weight	in cartoon	barcode
089940	6.800 kg	2 pcs	3800123153655

# AIR STAPLER

[BG] Такер пневматичен • [RO] Capsator pneumatic • [SR] Heftalica pneumatica • [MK] Хефталица пневматска • [RU] Пневматический степлер • [SL] Pnevmatiski spenjač • [EL] Συρραπτικό Πεπιεσμένου Αέρα • [HR] Pnevmatiska Klamerica • [FR] Agrafeuse à air • [IT] Cucitrice ad aria • [ES] Aera Stelo • [PT] Agrafador pneumático

## RD-AS01

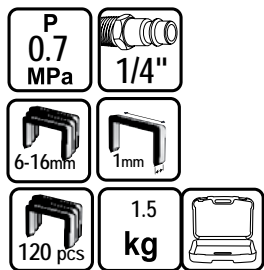

WORKING PRESSURE  
0.7 MPa

Art.No	gross weight	in cartoon	barcode
089908	2.0 kg	10	3800123123146

## RD-AS03

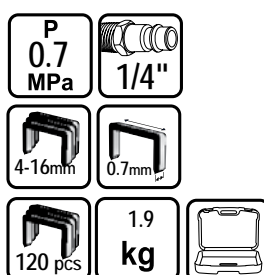

WORKING PRESSURE  
0.7 MPa

Art.No	gross weight	in cartoon	barcode
088101	2.0 kg	10	3800972002326

# COMBINATED AIR STAPLER AND NAILER

[BG] Такер пневматичен комбиниран • [RO] Capsator pneumatic combi • [SR] Heftalica pneumatica • [MK] Хефталица пневматска • [RU] Пневматический степлер • [SL] Pnevmatiski spenjač • [EL] Συρραπτικό Πεπιεσμένου Αέρα • [HR] Pnevmatiska Klamerica • [FR] Agrafeuse à air • [IT] Cucitrice ad aria • [ES] Aera Stelo • [PT] Agrafador pneumático

## RD-AS02

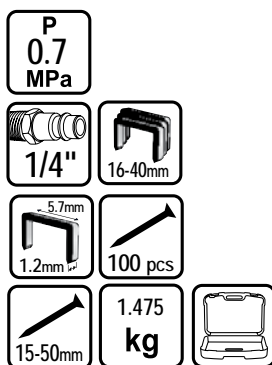

WORKING PRESSURE  
0.7 MPa

Art.No	gross weight	in cartoon	barcode
089923	2.560	10	3800123122439

## RD-AS04

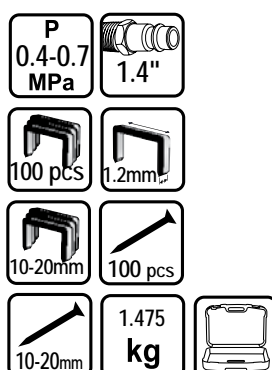

WORKING PRESSURE  
0.4 - 0.7 MPa

Art.No	gross weight	in cartoon	barcode
088102	1.520	10	3800972009141



## SANDBLASTING GUN SET RD-SBG01

[BG] Пистолет пясъкоструен с аксесоари • [RO] Pistol de sablat • [SR] Pištolj za peskarenje • [MK] Пиштол За Млаз • [RU] Пистолет для струйной обработки • [SL] Pištola Za Peskanje • [EL] Πιστόλι Ακτινοβόλησης • [HR] Pištolj za pjeskarenje • [FR] Set de pistolet de sablage • [IT] Set di pistole per sabbiatura • [ES] Sandblasting Pafilo • [PT] Pistola p/ lixar

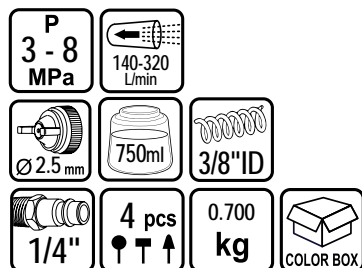

**WORKING PRESSURE**  
**3 - 8 MPa**

Art.No	gross weight	in cartoon	barcode
089942	2.080	10	3800123165382

## AIR DUSTER GUN

[BG] Пистолет за въздух • [RO] Pistol cu aer • [SR] Pištolj za izduvanje pneumatski • [MK] Пиштол за воздух • [RU] Пистолет продувочный • [SL] Pnevmatška pištola • [EL] Πιστόλι αέρος • [HR] Pištolj Za Ispuhivanje • [FR] Pistolet à air comprimé • [IT] Spolverino aria pistola • [ES] Armilo de aero • [PT] Pistola ar comprimido

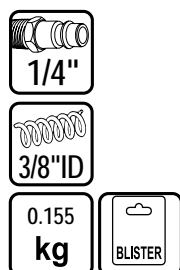

Art.No	gross weight	in cartoon	barcode
089802	0.170	100	3800123165382

## AIR CLEANING GUN RD-CG01

[BG] Пистолет за почистване с долно казанче • [RO] Pistol cu tija si rezervor • [SR] Pištolj za izduvanje pneumatski • [MK] Пиштол за чистење со долно казанче • [RU] Пистолет продувочный • [SL] Pnevmatška pištola • [EL] Πιστόλι αέρος • [HR] Pištolj za Ispuhivanje • [FR] Pistolet de nettoyage d'air • [IT] Pistola per la pulizia dell'aria • [ES] Aera purigado pafilo • [PT] Pistola ar comprimido

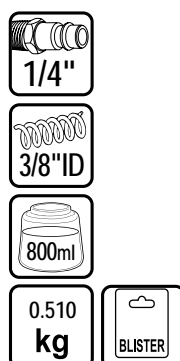

Art.No	gross weight	in cartoon	barcode
089916	0.660	10	3800123122408

## PISTOL-GRIP AIR INFLATOR WITH GAUGE RD-T101

[BG] Пистолет за гуми с манометър • [RO] Manometru • [SR] Pištolj za duvanje guma • [MK] Пиштол за пумпање са манометар • [RU] Пистолет для накачки • [SL] Pištola za polnjenje pnevmatik • [EL] Αεροπίστολο Πλήρωσης Αέρα με Μανόμετρο • [HR] Pištolj sa manometrom • [FR] Gonfleur pistol-grip air avec jauge • [IT] Gonfiatore ad aria compressa con manometro • [ES] Pistol-grip air inflator kun gauge • [PT] Pistola ar comprimido c/ manómetro

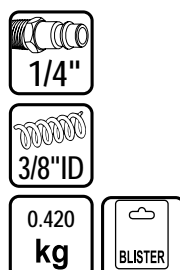

Art.No	gross weight	in cartoon	barcode
089904	0.420	40	3800123137075

## AIR BRUSH 7 PCS KIT RD-AB02

[BG] Аерограф еднодействащ 7 части • [RO] Aerograf • [SR] Set paintbrush pistolj za farbanje • [MK] Комплет за фарбање 7 ком. • [RU] Наносить краску распылителем • [SL] Zračni čopič • [EL] Σετ αερογράφου • [HR] Zračni Kist 7 dijelova • [FR] Kit de brosse à air 7pcs • [IT] Spazzola ad ariaKit 7 pezzi • [ES] Aera Broso 7pcs Kit • [PT] Kit pintura ar comprimido

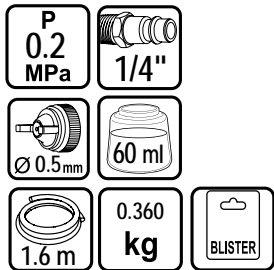

Art.No	gross weight	in cartoon	barcode
089936	0.520	20	3800123153389

## AIR BRUSH PUSH-BUTTON DOUBLE FUNCTION 8 PCS KIT RD-AB01

[BG] Аерограф двойнодействащ 8 части • [RO] Aerograf • [SR] Set paintbrush pistolj za farbanje • [MK] Комплет за фарбање 8 ком. • [RU] Наносить краску распылителем • [SL] Zračni čopič • [EL] Σετ αερογράφου • [HR] Zračni Kist 8 dijelova • [FR] Bouton pousseur double fonction Air Brush 8 pcs • [IT] Pulsante a spazzola d'aria a doppia funzione 8 pz • [ES] Air Brush Push-button Duobla Funkcio 8 komputiloj • [PT] Kit pintura ar comprimido

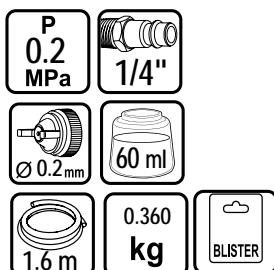

Art.No	gross weight	in cartoon	barcode
089935	0.490	20	3800123153327

## AIR SPRAY GUN FOR POLYURETANE INSULATION RD-PUSG13

[BG] Пистолет за полиуретан • [RO] Pistol de aerisire pentru izolație din poliuretana • [SR] Pištolj za raspršivanje vazduha za izolaciju od poliuretana • [MK] Пневматски распршувач за полиуретанска изолација • [RU] Воздушный распылитель для полиуретановой изоляции • [SL] Pištola za brizganje zraka za izolacijo iz poliuretana • [EL] Αεροβόλο όπλο για μόνωση πολυουρεθάνης • [HR] Puhala za raspršivanje zraka za poliuretansku izolaciju • [FR] Pistolet pneumatique pour isolation en polyuréthane • [IT] Pistola a spruzzo pneumatica • [ES] Pistola pulverizadora de aire para aislamiento de poliuretano • [PT] Pistola pneumática p/ projeção de isolamento poliuretano



WORKING PRESSURE  
0.6 MPa

Ø 1.8 mm

Art.No	gross weight	in cartoon	barcode
089944	0.470	20	3800972010215

## AIR GUN GRAVITY RD-SG02

[BG] Пистолет за боя с горно казанче • [RO] Pistol pentru vopsit • [SR] Pištolj za farbanje pneumatski • [MK] Пиштол за фарбање • [RU] Краскопульт • [SL] Brizgalna pištola • [EL] Πιστολι βερφης • [HR] Pištolj za boju • [FR] Bouton pousseur double fonction air brush • [IT] Pulsante a spazzola d'aria a doppia funzione • [ES] Air brush push-button duobla funkcio • [PT] Pistola de pintura c/ copo

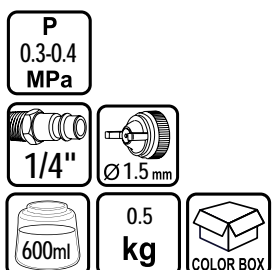

Art.No	gross weight	in cartoon	barcode
089909	0.600	20	3800123123177



## SPRAY GUN GRAVITY

[BG] Пистолет за боя с горно казанче • [RO] Pistol pentru vopsit • [SR] Pištolj za farbanje pneumatski • [MK] Пиштол за фарбање • [RU] Краскопулт • [SL] Brizgalna pištola • [EL] Πιστολι βαφης • [HR] Pištolj za boju • [FR] Bouton poussoir double fonction air brush • [IT] Pulsante a spazzola d'aria a doppia funzione • [ES] Air brush push-button duobla funkcio • [PT] Pistola de pintura c/ copo

### RD-SG05

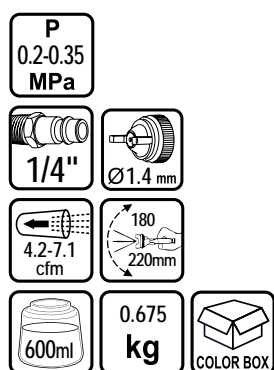

Art.No	gross weight	in cartoon	barcode
089934	0.920	20	3800123152238

### RD-SG04

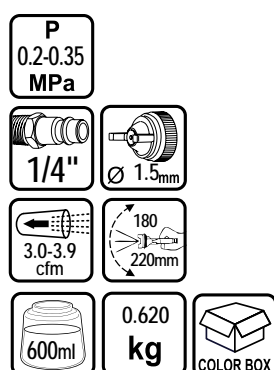

Art.No	gross weight	in cartoon	barcode
089933	1.100	10	3800123152221

## SPRAY GUN GRAVITY Laterally

[BG] Пистолет за боя с горно странично казанче • [RO] Pistol ptr. vopsit • [SR] Pištolj za farbanje pneumatski • [MK] Пиштол за фарбање • [RU] Краскопулт • [SL] Brizgalna pištola • [EL] Πιστολι βαφης • [HR] Pištolj Za Boju • [FR] Pulvériser la gravité du pistolet latéralement • [IT] Pistola a spruzzo Gravità lateralmente • [ES] Spray pafillo graveco flanke • [PT] Pistola de pintura c/ copo

### RD-SG03

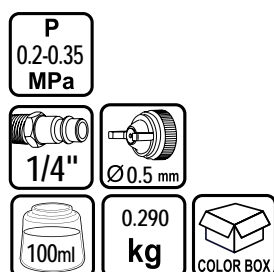

Art.No	gross weight	in cartoon	barcode
089910	0.490	20	3800123123184

### RD-SG12

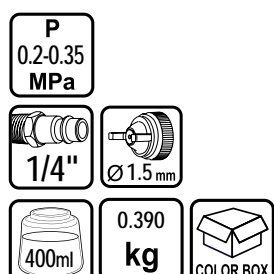

Art.No	gross weight	in cartoon	barcode
089943	0.750	10	3800972003507

## SPRAY GUN SUCTION RD-SG01

[BG] Пистолет за боя с долно казанче • [RO] Pistol pentru vopsit • [SR] Pištolj za farbanje pneumatski [MK] Пиштол за фарбање • [RU] Краскопулт • [SL] Brizgalna pištola • [EL] Πιστολι βερφης • [HR] Pištolj Za Boju • [FR] Aspiration de pistolet • [IT] Aspirazione pistola a spruzzo • [ES] Spray pingacnio [PT] Pistola de pintura sucção

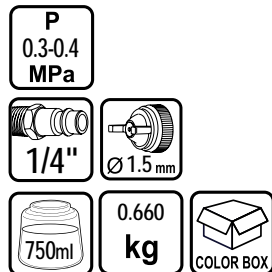

Art.No	gross weight	in cartoon	barcode
089903	0.800	10	3800123122132

## SPRAY GUN WITH TANK AND HOSE

[BG] Пистолет за боя с казанче и маркуч • [RO] Pistol ptr. vopsit cu rezervor • [SR] Pištolj za farbanje pneumatski sa kontejnerom i crevo • [MK] Пиштол за фарбање со сад и црево • [RU] Краскопулт Красконагнетательный бак [SL] Brizgalna pištola • [EL] Πιστολι βερφης • [HR] Pištolj Za Boju • [FR] Pistolet à peinture avec réservoir et tuyau • [IT] Pistola a spruzzo con serbatoio e tubo flessibile • [ES] Spray Pafilo kun tanko kaj maniko • [PT] Pistola de pintura sucção

### RD-PT01

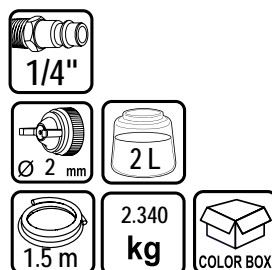

Art.No	gross weight	in cartoon	barcode
089914	4.000	5	3800123122163

### RD-PT02

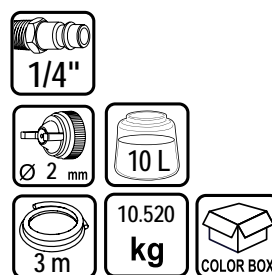

Art.No	gross weight	barcode
089915	7.000	3800123122156

## AIR TOOLS 5 PCS KIT SPRAY GUN SUCTION RD-AT01

[BG] Пистолети за боя долно и за въздух 5 бр. к-т • [RO] Set 5 buc. accesorii compresor • [SR] Alat set 5 kom pneumatski • [MK] Комплет за фарбање 5 ком. • [RU] Набор насадок к компрессору 5 шт • [SL] Zracni set 5u jednom • [EL] Εργαλεία Αέρος 5 τεμ • [HR] Pištolj Za Boju i Za Ispuhivanje 5 komada postaviti • [FR] Air Tools 5 pièces kit d'aspiration du pistolet • [IT] Aspiratore per pistola a spruzzo per kit Air Tools 5 pezzi • [ES] 5 komputilj kit spray gun suction • [PT] 5 pcs kit ferramentas pneumáticas

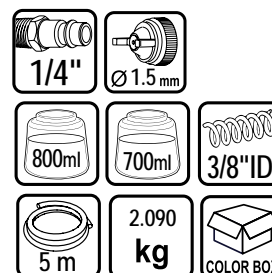

Art.No	gross weight	in cartoon	barcode
089902	2.100	10	3800123122149



**AIR TOOLS 5 PCS KIT SPRAY GUN GRAVITY RD-AT02**

[BG] Пистолети за боя горно и за въздух 5 бр. к-т • [RO] Set 5 buc. accesorii compresor • [SR] Alat set 5 kom pneumatski • [MK] Комплет за фарбање 5 ком. • [RU] Набор насадок к компрессору 5 шт  
 [SL] Zračni set 5u jednom • [EL] Εργαλεία Αέρος 5 τεμ • [HR] Pištolj Za Boju i Za Ispuhivanje 5 komada postaviti • [FR] Outils pneumatiques 5 pièces kit pistolet à gravité • [IT] Utensili pneumatici 5 pezzi kit pistola a spruzzo a gravità • [ES] 5 komputiloj kit spray pafilon • [PT] 5 pcs kit ferramentas pneumáticas

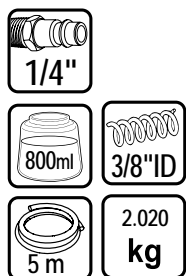

Art.No	gross weight	in cartoon	barcode
089913	0.660	10	3800123122231

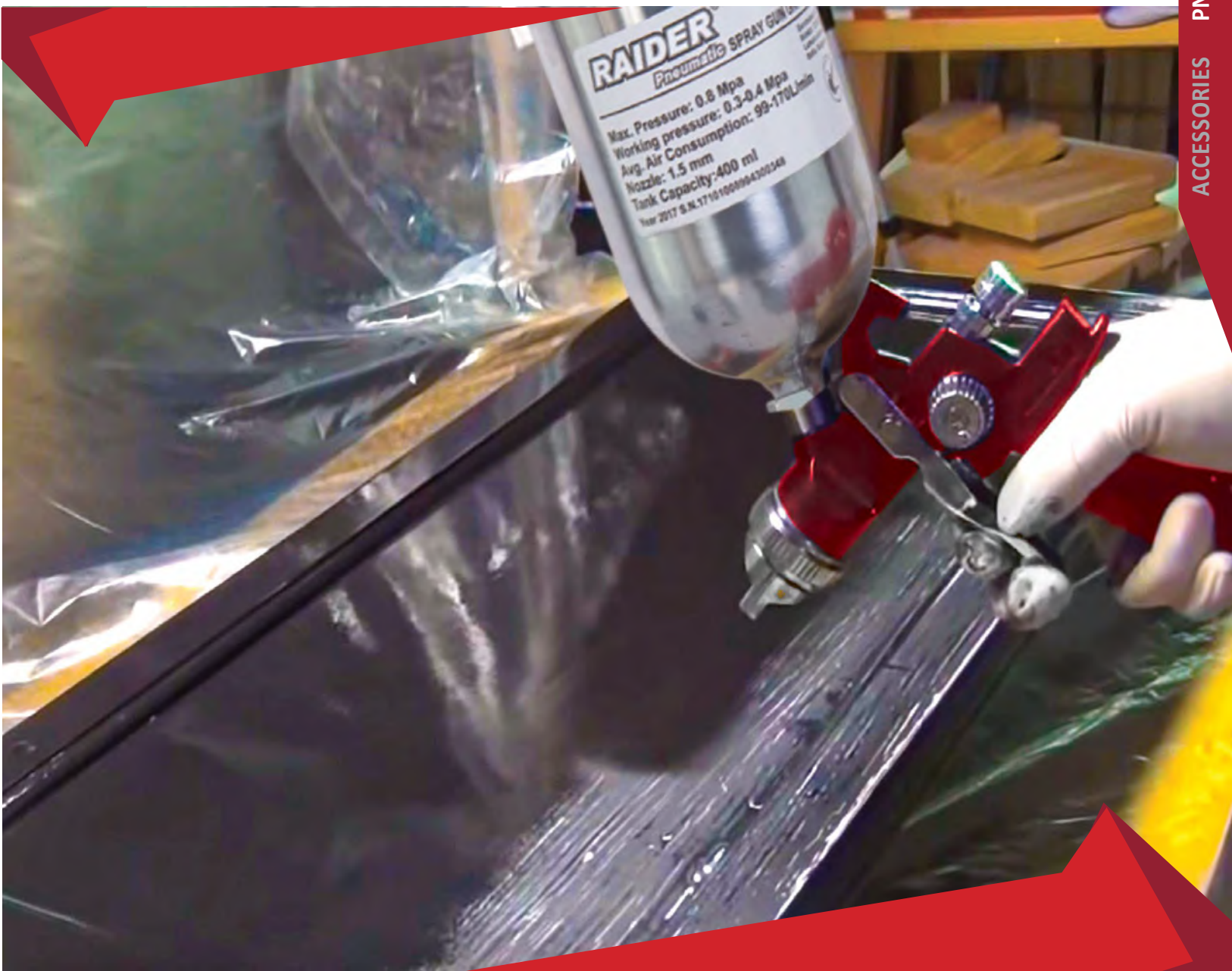



# RAIDER<sup>®</sup>

## Accessories





**COMBINED REGULATOR, AIR FILTER, WATER TRAP & LUBRICATOR RD-AF02**

[BG] Пневмоподготвяща група за пневматична система • [RO] Filtru aer, regulator & lubricator • [SR] Priprema grupa • [MK] Отворане на актог за компресор • [RU] Фильтр, регулятор, смазочных материалов • [SL] Grupa pripravna za zrak • [EL] Φίλτρο αέρος, ρυθμιστής και λιπαντής • [HR] Priprema grupa • [FR] Régulateur combiné, filtre à air, piège à eau et graisseur • [IT] Regolatore combinato, filtro aria, separatore d'acqua e lubrificatore • [ES] Combinata reguladora • [PT] Combinata reguladora



Art. No. 089918  
EAN: 3800123122170

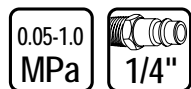

**LUBRICATOR M&F RD-A001**

[BG] Омаслител за пневматична система • [RO] Mini dispozitiv de uns • [SR] Zauljivač • [MK] Мазалица за подмачкувањ • [RU] Лубрикатор • [SL] Podmazivač • [EL] Λιπαντική για пневματικό σύστημα • [HR] Mini-podmazivač • [FR] Lubrifiant pour système pneumatique • [IT] Lubrificante per sistema pneumatico • [ES] Lubrika por neumática sistema • [PT] Lubrificante para sistema pneumático



Art. No. 089938  
EAN: 3800123153402



**AIR FILTER & WATER TRAP M&F RD-AF01**

• [BG] Влагоуловител за пневматична система M&F • [RO] Mini filtru • [SR] Skupljač vlage za pneumatske uređaje • [MK] Воздушен филтер и Стапика за вода • [RU] Воздушный фильтр и водоотделитель • [SL] Zračni filter • [EL] Φίλτρο αέρα και νερό παγίδα • [HR] Zračni filter za Vodu • [FR] Désaérateur pour système pneumatique • [IT] Disaeratore per sistema pneumatico • [ES] Deaerator por neumática sistema • [PT] Desaerador para sistema pneumático



Art. No. 089917  
EAN: 3800123122002



**AIR REGULATOR**

• [BG] Редуцир вентил с манометър F • [RO] Regulator de aer F • [SR] Regulator pritiska • [MK] Редуцатор на притисок • [RU] Воздушный регулятор • [SL] Zračni regulator • [EL] ρυθμιστής αέρα • [HR] Reducir ventil sa manometrom • [FR] Régulateur d'air • [IT] Regolatore d'aria • [ES] Aera reguligilo • [PT] Regulador de ar



Art. No. 110601  
EAN: 3800123159299

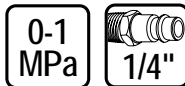

**MANOMETER**

• [BG] Манометър • [RO] Manometru • [SR] Merač pritiska • [MK] Мерач на притисок • [RU] Манометр • [SL] Merlec tiaka • [EL] όργανο πίεσης • [HR] Manometar • [FR] Manomètre • [IT] Manometro • [ES] Manometer • [PT] Manómetro



Art. No. 110602  
EAN: 3800123159305

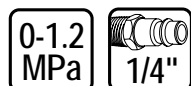

**AIR PU HOSE WITH QUICK COUPLINGS M&F RD-CH02**

[BG] Маркуч полиуретанов за компресор с бързи връзки • [RO] Furtun compresor • [SR] Crevo spiralno za vazduh • [MK] Спирално црево за воздух • [RU] Шланги спиральные пневматические • [SL] Špiralová hadica • [EL] Σωλήνα αέρος σπирάλ • [HR] Crijevo za kompresor • [FR] Tuyau en polyuréthane pour compresseur • [IT] Tubo in poliuretano per compressore • [ES] Poliuretano per komponajo • [PT] Mangueira de poliuretano para compressor



Art. No. 089919  
EAN: 3800123122033

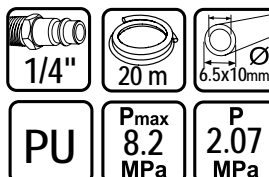

**AIR PU SPIRAL HOSE WITH QUICK COUPLINGS M&F**

• [BG] Маркуч за компресор полиуретанов с бързи връзки • [RO] Furtun compresor • [SR] Crevo spiralno za vazduh • [MK] Спирално црево за воздух • [RU] Шланги спиральные пневматические • [SL] Špiralová hadica • [EL] Σωλήνα αέρος σπирάλ • [HR] Crijevo za kompresor spiralno • [FR] Tuyau en polyuréthane pour compresseur • [IT] Tubo in poliuretano per compressore • [ES] Poliuretano per komponajo • [PT] Mangueira de poliuretano para compressor

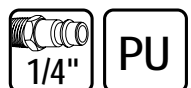

art. №	Size (Ø)	P (MPa)	P <sub>max</sub> (MPa)	Lenght (m)	BARCODE
110701	6.5x9.5mm	0.83	2.4	5	3800123159312
139904	6.5x9.5mm	0.83	2.4	10	3800123123429
110702	8x12mm	0.83	2.4	15	3800123159329
110703	10x14mm	0.83	2.4	15	3800123159336



**AIR QUICK COUPLER MALE THREAD**

[BG] Накрайник пневматичен бърза връзка М • [RO] Conector rapid M • [SR] Spojnica muška • [MK] Спојка, машки дел • [RU] Штуцер, с внешней резьбой • [SL] Viti sklopke • [EL] Σύνδεσμος, αρσενικό μέρος • [HR] Spojnica muška • [FR] Raccord rapide d'air • [IT] Ugello pneumatico • [ES] Pneumática cigaredingo • [PT] Bico pneumático



art. №	Size (")	BARCODE
089937	1/2	3800123153396
089927	1/4	3800123122477

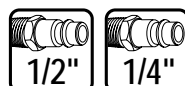

**AIR QUICK COUPLER FEMALE THREAD QC02**

[BG] Накрайник пневматичен бърза връзка F • [RO] Conector rapid F • [SR] Spojnica ženska • [MK] Спојка, женски дел • [RU] Муфта соединительная, с внутренней резьбой • [SL] Spojka sklopke • [EL] Σύνδεσμος, θηλυκό μέρος • [HR] Spojnica ženska • [FR] Raccord rapide d'air • [IT] Ugello pneumatico • [ES] Pneumática cigaredingo • [PT] Bico pneumático



Art. No. 089925  
EAN: 3800123122453



**AIR QUICK COUPLER**

[BG] Накрайник пневматичен бърза връзка маркуч • [RO] Conector • [SR] Spojnica za crevo • [MK] Спојка • [RU] Штуцер • [SL] Sklopke • [EL] Σύνδεσμος, αρσενικό μέρος • [HR] Spojnica zraka brza crijeva • [FR] Raccord rapide d'air • [IT] Ugello pneumatico • [ES] Pneumática cigaredingo • [PT] Bico pneumático



art. №	Size(Ø)	BARCODE
089930	6mm	3800123122507
110901	8mm	3800123159381
110902	10mm	3800123159398



## AIR QUICK COUPLER MALE THREAD QC05

[BG] Накрайник пневматичен бърза връзка М • [RO] Conector rapid M • [SR] Spojnica muška • [MK] Спoјкa, машки дел • [RU] Штуцер, с внешней резьбой • [SL] Vtič sklopke • [EL] Σύνδεσμος, αρσενικό μέρος • [HR] Spojnica muška • [FR] Raccords avec filetage mâle • [IT] Raccordi con filetto maschio • [ES] Agordoj kun vira fadeno • [PT] Conexões com rosca macho

Art. No. 089928  
EAN: 3800123122484



## AIR QUICK COUPLER FEMALE THREAD QC03

[BG] Накрайник пневматичен бърза връзка F • [RO] Conector rapid F • [SR] Spojnica ženska • [MK] Спoјкa, женски дел • [RU] Муфта соединительная, с внутренней резьбой • [SL] Spojka sklopke • [EL] Σύνδεσμος, θηλυκό μέρος • [HR] Spojnica ženska • [FR] Couplage avec filetage interne • [IT] Accoppiamento, con filettatura interna • [ES] Kunigo, kun interna fadeno • [PT] Acoplamento, com rosca interna

Art. No. 089926  
EAN: 3800123122460



## AIR QUICK COUPLER HOSE

[BG] Накрайник пневматичен за бърза връзка маркуч • [RO] Conector • [SR] Spojnica za crevo • [MK] Спoјкa • [RU] Штуцер • [SL] Sklopke • [EL] Σύνδεσμος, αρσενικό μέρος • [HR] Spojnica zraka brza crijeva • [FR] Raccords • [IT] Ugello pneumatico • [ES] Pneuimatika cigaredingo • [PT] Bico pneumático

art. №	Size(Ø)	BARCODE
089929	6mm	3800123122491
110903	8mm	3800123159404
110904	10mm	3800123159411



## AIR QUICK COUPLINGS 5PCS KIT QC01

[BG] Накрайници пневм. за бърза връзка 5 бр. к-т • [RO] 5Pcs/Set conectori • [SR] Spojnica za crevo • [MK] Спoјкa сет 5 ком • [RU] Штуцери 5бр • [SL] Sklopke 5 kos • [EL] Σύνδεσμος, αρσενικό μέρος 5 τεμάχια • [HR] Spojnica zraka brza 5 kom. postaviti • [FR] Raccords • [IT] Unione • [ES] Fittings • [PT] A articulação da fenda

Art. No. 089912  
EAN: 380012312312369

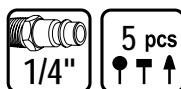

## Y-TYPE CONNECTOR F

[BG] Тройник "Y" F • [RO] Y-Tip conector F • [SR] Račva pneumatska ženska • [MK] Спoјкa Y-тип женски дел • [RU] Тройник Y-образный с внутренней резьбой • [SL] Sklopke Y-type F • [EL] Σύνδεσμος, αρσενικό μέρος Y-type F • [HR] Tlačni razdjelnik spojnice • [FR] Connecteur de type Y • [IT] Connettore tipo Y • [ES] Tipo konektilo Y • [PT] Conector tipo Y

Art. No. 110804  
EAN: 3800123159374



## PLUG FOR HOSE OF INFLATING GUN

[BG] Накрайник за помпана на гуми за маркуч • [RO] Mufă furturn pentru pistol aer • [SR] Spojnica za crevo za pištolja naduvavanje • [MK] Спoјкa за црево за пумпање на гуми • [RU] Насадка для накачивания шин шланга • [SL] Sklopke • [EL] Σύνδεσμος, αρσενικό μέρος • [HR] Spojnice za napuhavanje guma za crijeva • [FR] Buse pour gonfler les pneus du tuyau • [IT] Ugello per gonfiare le gomme del tubo • [ES] Borrilo por inflakti la pneuiojn de la maniko • [PT] Bocal para inflar os pneus da mangueira

Art. No. 110906  
EAN: 3800123159435



## CUTTING DISC FOR METAL

[BG] Диск за метал • [RO] Disc pentru metal • [SR] Rezna ploča za metal • [MK] Брус камен за метал RU • Диск для резки металла • [SL] Rezne plošče • [EL] Δίσκοι κοπής μετάλλων • [HR] Ploče za rezanje metala • [FR] Disque de coupe pour métal • [IT] Disco da taglio per metallo • [ES] Trancha disco por metalo maniko • [PT] Trancha Disko por metalo



art. №	Ø (mm)	Ø <sub>1</sub> (mm)	D (mm)	BARCODE
169904	100	16	1.0	3800123143731
169902	100	16	3.0	3800123141928
169903	100	16	6.0	3800123141935
169901	75	9.5	1.6	3800123122514



## CONICAL REDUCTION

[BG] Адаптер BPH • [RO] Niplu de reducere dublu • [SR] Nipla reducir dupla • [MK] Адаптер • [RU] Адаптер • [SL] Adapter • [EL] Προσαρμογέας • [HR] Redukcija pocinčana • [FR] Réduction conique • [IT] Riduzione conica • [ES] Konusa redukto • [PT] Redução cônica

art. №	Size(M / °)	BARCODE
110806	1/2" M-1/4"	3800123159350
110805	1/2" M-3/8"	3800123159343
110803	3/8" M-1/4"	3800123159367



## STAPLES FOR RD-AS01

• [BG] Скоби за пневматичен такер • [RO] Set capse • [SR] Klamerice za pneumatsku heftalicu • [MK] Муниција за хефталка • [RU] Скобы для пневматического степлера • [SL] Sponke • [EL] Συνοχεύς για συρραπτική • [HR] Klamerice za pneumatska klamerica • [FR] Sauterelles pneumatiques • [IT] Morsetti di inclinazione pneumatici • [ES] Pneuimaj ïiltaj abrazoj • [PT] Grampos pneumáticos de inclinação

art. №	H (mm)	W (mm)	D (mm)	BARCODE
511300	6	12.8	1	3800123104831
511308	8	12.8	1	3800123122248
511309	10	12.8	1	3800123122255
511310	12	12.8	1	3800123122262
511311	14	12.8	1	3800123122279
511312	16	12.8	1	3800123122286

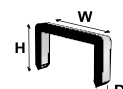

COLOR BOX  
5000 PCS



**STAPLES FOR RD-AS02**

[BG] Скоби за пневматичен такер • [RO] Set capse • [SR] Klamarice za pneumatsku heftalicu • [MK] Муниција за хефталка • [RU] Скобы для пневматического степлера • [SL] Žebelj • [EL] Συνοχές για συρραπτικά • [HR] Klamerice za pneumatska klamera • [FR] Sauterelles pneumatiques • [IT] Morsetti di inclinazione pneumatici • [ES] Pneuñaj tiltaj abrazoj • [PT] Grampos pneumáticos de inclinação

art. №	H (mm)	W (mm)	D (mm)	BARCODE
511330	16	5.7	1.2	3800123139710
511317	25	5.7	1.2	3800123122521
511318	32	5.7	1.2	3800123122538
511350	40	5.7	1.2	3800123171574

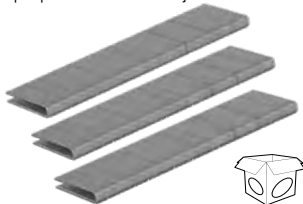

COLOR BOX  
5000 PCS



**NAILS FOR RD-AS02**

[BG] Пирони за пневматичен такер • [RO] Set capse pentru [SR] Klamarice za pneumatsku heftalicu • [MK] Муниција за хефталка • [RU] Скобы для пневматического степлера • [SL] Sponke • [EL] Συνοχές για συρραπτικά • [HR] Klamerice za pneumatska klamera • [FR] Sauterelles pneumatiques • [IT] Morsetti di inclinazione pneumatici • [ES] Pneuñaj tiltaj abrazoj • [PT] Grampos pneumáticos de inclinação

art. №	H (mm)	D (mm)	BARCODE
511313	15	1	3800123122293
511314	25	1	3800123122309
511315	35	1	3800123122316
511316	45	1	3800123122323



COLOR BOX  
5000 PCS



**STAPLES FOR RD-AS03, RD-AS04**

[BG] Скоби за пневматичен такер • [RO] Set capse pentru [SR] Klamarice za pneumatsku heftalicu • [MK] Муниција за хефталка • [RU] Скобы для пневматического степлера • [SL] Sponke • [EL] Συνοχές για συρραпτικά • [HR] Klamerice za pneumatska klamera • [FR] Agrafes pour agrafeuse pneumatique • [IT] Graffette per cucitrice pneumatica • [ES] Staples por pneuñatika stapilo • [PT] Grampos para grampeador pneuñatico

art. №	H (mm)	W (mm)	D (mm)	Pcs	BARCODE
511401	6	9.1	0.7	10000	3800972002340
511402	8	9.1	0.7	10000	3800972002357
511403	10	9.1	0.7	10000	3800972002364
511404	12	9.1	0.7	10000	3800972002371
511405	14	9.1	0.7	10000	3800972002388
511406	16	9.1	0.7	10000	3800972002395
511407	10	10	1.2	5000	3800972010338
511408	12	10	1.2	5000	3800972010345
511409	14	10	1.2	5000	3800972010352
511410	16	10	1.2	5000	3800972010369
511411	20	10	1.2	5000	3800972010376



COLOR BOX  
5000 PCS



**DRILL BITS HSS SET**

[BG] Свредла за метал HSS к-т • [RO] Burghiu HSS Pcs/Set • [SR] Burgija hss set • [MK] Бурñија за метал [RU] Набор сверла по металлу • [SL] Set svetrov • [EL] Τρυπάνια για μέταλλα • [HR] Set svrdla za metal HSS • [FR] Forets à métaux HSS • [IT] Punte per metallo HSS • [ES] Metalaj taladraj bitoj HSS • [PT] Brocas de metal HSS

art. №	Ø (mm)	drills/ pcs	BARCODE
157104	1.5-6.5	13 pcs 1.5, 2, 2.5, 3, 3.2, 3.5, 4, 4.5, 4.8, 5, 5.5, 6, 6.5mm	3800123101724
157105	1-10	19 pcs 1, 1.5, 2, 2.5, 3, 3.5, 4, 4.5, 5, 5.5, 6, 6.5, 7, 7.5, 8, 8.5, 9, 9.5, 10 mm	3800123101731

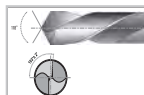

**DRILL BITS SET HSS+TIN (TITANIUM NITRIDE)**

[BG] Свредла за метал к-т HSS+TIN (титанов нитрид) • [RO] Burghiu HSS Titanium Plated • [SR] Burgija hss+tin • [MK] Бурñија за метал hss+tin • [RU] Набор сверла по металлу • [SL] Set svetrov • [EL] Τρυπάνια για μέταλλα • [HR] Set svrdla za metal HSS • [FR] Forets à métaux HSS • [IT] Punte per metallo HSS • [ES] Metalaj taladraj bitoj HSS • [PT] Brocas de metal HSS

art. №	Ø (mm)	drills/ pcs	BARCODE
157107	2-8	13 pcs 2, 2.5, 3, 3.5, 4, 4.5, 5, 5.5, 6, 6.5, 7, 7.5, 8 mm	3800123101755
157108	1-10	19 pcs 1, 1.5, 2, 2.5, 3, 3.5, 4, 4.5, 5, 5.5, 6, 6.5, 7, 7.5, 8, 8.5, 9, 9.5, 10 mm	3800123101762

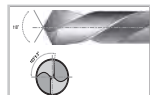

**DRILL BITS SET HSS+R**

[BG] Свредла за метал к-т HSS+R • [RO] Burghiu HSS+R Pcs/Set • [SR] Burgija HSS+R kom./set • [MK] Бурñија за метал HSS+R бр/сет • [RU] Набор сверла по металлу • [SL] Set svetrov • [EL] Τρυπάνια για μέταλλα • [HR] Set svrdla za metal HSS+R • [FR] Forets à métaux HSS • [IT] Punte per metallo HSS • [ES] Metalaj taladraj bitoj HSS • [PT] Brocas de metal HSS

art. №	Ø (mm)	drills/ pcs	BARCODE
157110	2-8	6 pcs 2, 3, 4, 5, 6, 8 mm	3800123168482
157111	1-10	10 pcs 1, 2, 3, 4, 5, 6, 7, 8, 9, 10 mm	3800123168499



BLISTER

**DRILL BITS FOR METAL 15 PCS SET HSS+TIN**

[BG] Свредла за метал 15 бр. к-т • [RO] Burghiu 15 Pcs/Set • [SR] Burgija HSS+TIN 15 kom./set • [MK] Бурñија за метал 15 бр/сет • [RU] Набор сверла по металлу • [SL] Set svetrov 15 del • [EL] Τρυπάνια για μέταλλα 15 τεμ • [HR] Set svrdla za metal 15 kom • [FR] Forets à métaux • [IT] Punte per metallo • [ES] Metalaj taladraj bitoj • [PT] Brocas de metal

Art. No. 157789  
EAN: 3800123169540

Ø 1.5-10mm  
DRILLS 10 pcs:  
Ø1.5x2, 2.0x2, 2.5x2, 3.0, 3.2, 3.5, 4.0, 4.5, 5.0, 6.0, 8.0, 10.0mm



BLISTER

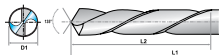

**DRILL BITS FOR METAL & CONCRETE 17 PCS SET**

[BG] Свредла за метал и бетон 17 бр. к-т • [RO] Burghiu pentru metal și beton • [SR] Burgija za metal i beton 17 kom./set • [MK] Бурñија за метал и бетон 17 бр/сет • [RU] Набор сверла по металлу и бетону 17 шт • [SL] Set svetrov kovine in beton 17 del • [EL] Τρυπάνια για μέταλλο και σκυρόδεμα 17 τεμ • [HR] Set svrdla za metal i beton 17 kom • [FR] Forets pour le métal et le béton • [IT] Trapani per metallo e calcestruzzo • [ES] Drijo por metalo kaj betono • [PT] Brocas para metal e betão

Art. No. 157796  
EAN: 3800123169618

Ø 1.5-10mm  
Metal 12 pcs: Ø1.5, 2.0, 2.5, 3.0, 3.2, 3.5, 4.0, 4.5, 4.8, 5.0, 5.5, 6.0mm  
Concrete 5 pcs: Ø3.0, 5.0, 6.0, 8.0, 10.0mm



BLISTER

## DRILL BIT HSS+R

[BG] Свърдело за метал HSS+R • [RO] Burghiu HSS+R • [SR] Burgija HSS+R • [MK] Бургџија за метал HSS+R • [RU] Сверло по металлу HSS+R • [SL] Sveder HSS+R • [EL] Τρυπάνι για μέταλλα HSS+R • [HR] Svrdla za zidove, okrugli prihvat HSS+R • [FR] Forets à métaux HSS • [IT] Punte per metallo HSS • [ES] Metalaj taladraj bitoj HSS • [PT] Brocas de metal HSS

art. №	D1 (mm)	L1 (mm)	L2 (mm)	Qty (pcs)	BARCODE
157678	1.0	34	12	2	3800123168505
157679	1.5	40	18	2	3800123168512
157680	2.0	49	24	2	3800123168529
157681	2.5	57	30	2	3800123168536
157682	3.0	61	33	2	3800123168543
157683	3.2	65	36	2	3800123168550
157684	3.5	70	39	2	3800123168567
157685	4.0	75	43	2	3800123168574
157686	4.2	75	43	1	3800123168581
157687	4.5	80	47	1	3800123168598
157688	5.0	86	52	1	3800123168604
157689	6.0	93	57	1	3800123168611
157690	6.5	101	63	1	3800123168628
157691	7.0	109	69	1	3800123168635
157692	8.0	117	75	1	3800123168642
157693	10.0	133	87	1	3800123168659
157694	12.0	151	101	1	3800123168666

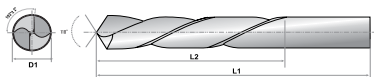

## STEP DRILL BIT SPIRAL FLUTE HSS+TIN

[BG] Свърдело за ламарина стъпаловидно HSS+TIN • [RO] Burghiu HSS+TIN • [SR] Burgija HSS+TIN • [MK] Бургџија за метал HSS+TIN • [RU] Набор сверла по металлу HSS+TIN • [SL] Sveder HSS+TIN • [EL] Τρυπάνια για μέταλλα HSS+TIN • [HR] Set svrdla za metal HSS+TIN • [FR] Perceuse pour tôle HSS+TIN • [IT] Trapano per lamiera HSS+TIN • [ES] Taladros HSS+TIN • [PT] Broca para metal de folha HSS+TIN

art. №	Ø(mm)	HEX	BARCODE
150678	4-12	1/4"	3800972004986
150679	4-20	1/4"	3800972004993
150680	6-30	1/4"	3800972005006



## DRILL BIT HSS TIN

[BG] Свърдело за метал HSS • [RO] Burghiu HSS • [SR] Burgija HSS • [MK] Бургџија за метал HSS • [RU] Сверло по металлу HSS • [SL] Sveder HSS • [EL] Τρυπάνι για μέταλλα HSS • [HR] Svrdal za metal HSS • [FR] Forets à métaux HSS • [IT] Punte per metallo HSS • [ES] Metalaj taladraj bitoj HSS • [PT] Brocas de metal HSS

art. №	D1 (mm)	L1 (mm)	L2 (mm)	Qty (pcs)	BARCODE
150655	1.0	34	12	2	3800123164262
150656	1.5	40	18	2	3800123164279
150657	2.0	49	24	2	3800123164286
150658	2.5	57	30	2	3800123164293
150659	3.0	61	33	2	3800123164309
150660	3.2	65	36	2	3800123164316
150661	3.5	70	39	2	3800123164323
150662	4.0	75	43	2	3800123164330
150663	4.2	75	43	1	3800123164347
150664	4.5	80	47	1	3800123164354
150665	4.8	86	52	1	3800123164361
150666	5.0	86	52	1	3800123164378
150667	5.5	93	57	1	3800123164385
150668	6.0	93	57	1	3800123164392
150669	6.5	101	63	1	3800123164408
150670	7.0	109	69	1	3800123164415
150671	8.0	117	75	1	3800123164422
150672	8.5	117	75	1	3800123164439
150673	9.0	125	81	1	3800123164446
150674	10.0	133	87	1	3800123164453
150675	11.0	142	94	1	3800123164460
150676	12.0	151	101	1	3800123164477
150677	13.0	151	101	1	3800123164484

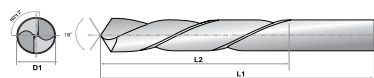

DIN 338

HSS+TIN SPLIT POINT TYPE C



## DRILL BITS 6 PCS SET HSS-CO

[BG] Свърделка за метал 6 бр. к-т HSS-Co • [RO] Burghiu HSS-Co 6 Pcs/Set • [SR] Burgija HSS-Co 6 kom./set • [MK] Бургџија за метал HSS-Co 6 бр/сет • [RU] Набор сверла по металлу 6 шт HSS-Co • [SL] Set svdrov HSS-Co 6 del • [EL] Τρυπάνια για μέταλλα HSS-Co 6 τεμ • [HR] Set svrdla za metal HSS-Co 6 kom • [FR] Forets à métaux HSS-Co • [IT] Punte per metallo HSS-Co • [ES] Metalaj taladraj bitoj HSS-Co • [PT] Brocas de metal HSS-Co

Art. No. 157112  
EAN: 3800123168673  
**Ø2-8mm**  
DRILLS  
6 pcs: 2, 3, 4, 5, 6, 8 mm

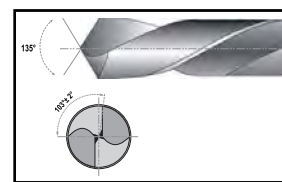



## DRILL BIT HSS-CO

[BG] Свърдело за метал HSS-Co • [RO] Burghiu HSS-Co • [SR] Burgija HSS-Co • [MK] Бургџија за метал HSS-Co • [RU] Сверло по металлу HSS-Co • [SL] Sveder HSS-Co • [EL] Τρυπάνι για μέταλλα HSS-Co • [HR] Svrdal za metal HSS-Co • [FR] Forets à métaux HSS-Co • [IT] Punte per metallo HSS-Co • [ES] Metalaj taladraj bitoj HSS-Co • [PT] Brocas de metal HSS-Co

art. №	D1 (mm)	L1 (mm)	L2 (mm)	Qty (pcs)	BARCODE
157695	2.0	49	24	2	3800123168680
157696	2.5	57	30	2	3800123168697
157697	3.0	61	33	2	3800123168703
157698	3.2	65	36	2	3800123168710
157699	3.5	70	39	2	3800123168727
157700	4.0	75	43	2	3800123168734
157715	4.2	75	43	1	3800123168741
157716	4.5	80	47	1	3800123168758
157717	5.0	86	52	1	3800123168765
157718	6.0	93	57	1	3800123168772
157719	6.5	101	63	1	3800123168789
157720	7.0	109	69	1	3800123168796
157721	8.0	117	75	1	3800123168802
157722	10.0	133	87	1	3800123168819
157723	12.0	151	101	1	3800123168826



### COBALT

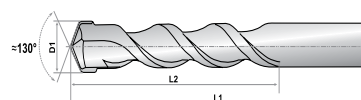
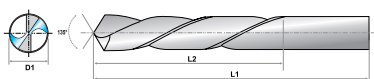

## MASONRY DRILL BIT

[BG] Свърдело за бетон • [RO] Carote diamantate • [SR] Burgija za zid • [MK] Бургџија • [RU] Сверло по бетону • [SL] Sveder za beton • [EL] τρυπάνι για το σκυρόδεμα • [HR] Svrdlo za zidove, okoljih prihvat • [FR] Forets de maçonnerie • [IT] Bit di perforazione in muratura • [ES] Konkretaj triloj • [PT] Brocas de concreto

art. №	D1 (mm)	L1 (mm)	L2 (mm)	BARCODE
157724	Ø3	70	30	3800123168840
157725	Ø4	75	40	3800123168857
157726	Ø5	85	50	3800123168864
157727	Ø6	100	60	3800123168871
157729	Ø8	120	80	3800123168895
157730	Ø10	150	90	3800123168901



## MASONRY DRILL BITS 5 PCS SET

[BG] Свърдела за бетон 5 бр. комплект • [RO] 5Pcs/Set burghie • [SR] Burgija za zid Set 5 kom • [MK] Бургџија сет 5 ком • [RU] Сверло по бетону набор 5 шт • [SL] Sveder za beton nabor 5 kos • [EL] Τρυπάνι για το σκυρόδεμα сет 5 τεμαχίων • [HR] Svrdla za zidove 5kom • [FR] Forets de maçonnerie • [IT] Bit di perforazione in muratura • [ES] Konkretaj triloj • [PT] Brocas de concreto

Ø 4, 5, 6, 8, 10mm

Art. No. 157113  
EAN: 3800123168833

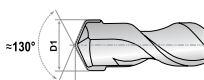

## MASONRY DRILL BITS 15 PCS SET

[BG] Свърдела за бетон 15 бр. комплект • [RO] 15 Pcs/Set burghie • [SR] Burgija za zid Set 15 kom • [MK] Бургџија сет 15 ком • [RU] Сверло по бетону набор 15 шт • [SL] Sveder za beton nabor 15 kos • [EL] τρυπάνι για το σκυρόδεμα сет 15 τεμαχίων • [HR] Svrdla za zidove 15kom • [FR] Forets de maçonnerie • [IT] Bit di perforazione in muratura • [ES] Konkretaj triloj • [PT] Brocas de concreto

Ø 3-10mm

Masonry Drills 15 pcs:  
3.0x3, 4.0x3, 5.0x3,  
6.0x2, 8.0x2, 10.0x2

Art. No. 157790  
EAN: 3800123169557

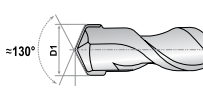

## BRAD POINT DRILL BITS FOR WOOD 5 PCS SET

[BG] Свърдела за дърво 5 бр. к-т • [RO] Burghiu ptr lemn 5 buc/Set • [SR] Burgija za drvo 5 kom./set • [MK] Бургџија за дрво 5 бр/сет • [RU] Набор сверла по дереву 5 шт. • [SL] Set svedrov lesa 5 del • [EL] Τρυπάνια για ξύλο 5 τεμ • [HR] Set svrdla za drvo 5kom • [FR] Jeu de forets pour bois • [IT] Set di punte per legno • [ES] Aro da taladraj por ligno • [PT] Conjunto de brocas para madeira

Ø 4, 5, 6, 8, 10mm

Art. No. 157114  
EAN: 3800123168918

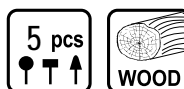

## BRAD POINT DRILL BITS FOR WOOD 15 PCS SET

[BG] Свърдела за дърво 15 бр. к-т • [RO] Burghiu ptr lemn 15 buc/Set • [SR] Burgija za drvo 15 kom./set • [MK] Бургџија за дрво 15 бр/сет • [RU] Набор сверла по дереву 15 шт. • [SL] Set svedrov lesa 15 del • [EL] Τρυπάνια για ξύλο 15 τεμ • [HR] Set svrdla za drvo 15kom • [FR] Jeu de forets pour bois • [IT] Set di punte per legno • [ES] Aro da taladraj por ligno • [PT] Conjunto de brocas para madeira

Ø 3, 3.5, 4, 4.5, 5, 5.5, 6, 6.5, 7, 8, 10mm

DRILLS 15 pcs:  
Ø3.0x3, 3.5x2, 4.0x2,  
4.5, 5.0, 5.5, 6.0, 6.5,  
7.0, 8.0, 10.0mm

Art. No. 157791  
EAN: 3800123169564

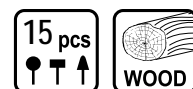

## BRAD POINT DRILL BITS FOR WOOD

[BG] Свредло за дърво • [RO] Burghiu pentru lemn • [SR] Burgija za drvo • [MK] Бургџија за дрво  
 • [RU] Сверла по древо • [SL] Svedro lesa • [EL] Τρυπάνια για ξύλο • [HR] Svrđalo za drvo  
 • [FR] Jeu de forets pour bois • [IT] Set di punte per legno • [ES] Aro da taladroj por ligno  
 • [PT] Conjunto de brocas para madeira

art. №	Ø (mm)	BARCODE
157731	Ø3	3800123168925
157732	Ø4	3800123168932
157733	Ø5	3800123168949
157734	Ø6	3800123168956
157736	Ø8	3800123168970
157737	Ø10	3800123168987
157738	Ø12	3800123168994

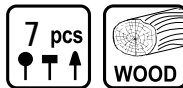

## FLAT SPEED SPADE BITS FOR WOOD 1/4" HEX SHANK

[BG] Свредла за дърво плоски 1/4" hex • [RO] Burghiu ptr lemn 1/4" hex • [SR] Burgija za drvo 1/4" hex • [MK] Бургџија за дрво 1/4" hex • [RU] Набор сверла по древо 1/4" hex • [SL] Set svedrov lesa 1/4" hex • [EL] Τρυπάνια για ξύλο 1/4" hex • [HR] Set svrdla za drvo 1/4" hex • [FR] Jeu de forets pour bois • [IT] Set di punte per legno • [ES] Aro da taladroj por ligno • [PT] Conjunto de brocas para madeira

art. №	Ø (mm)	BARCODE
157739	Ø14	3800123169014
157740	Ø16	3800123169021
157741	Ø20	3800123169038
157742	Ø22	3800123169045
157743	Ø25	3800123169052
157744	Ø28	3800123169069
157745	Ø30	3800123169076



## GLASS AND TILE DRILL BITS 5 PCS SET

[BG] Свредла за стъкло 5 броя к-т • [RO] Burghiu ptr sticlă 5 buc/Set • [SR] Burgija za staklo 5 kom./set • [MK] Бургџија за стакло 5 бр/сет • [RU] Набор сверла по стеклу 5 шт. • [SL] Set svedrov steklo 5 del • [EL] Τρυπάνια για ποτήρι 5 τεμ • [HR] Set svrdla za staklo 5 kom • [FR] Set de perceuse à verre • [IT] Trapano fissato su vetro • [ES] Fiksita pilko • [PT] Conjunto de broca de vidro

Art. No. 157798

EAN: 3800123169632

Ø 3-10mm

DRILLS 5 pcs: Ø3.0, 4.0, 6.0, 8.0, 10.0mm



## GLASS AND TILE DRILL BITS 3 PCS SET

[BG] Свредла за стъкло 3 броя к-т • [RO] Burghiu ptr sticlă 3 buc/Set • [SR] Burgija za staklo 3 kom./set • [MK] Бургџија за стакло 3 бр/сет • [RU] Набор сверла по стеклу 3 шт. • [SL] Set svedrov steklo 3 del • [EL] Τρυπάνια για ποτήρι 3 τεμ • [HR] Set svrdla za staklo 3 kom • [FR] Set de perceuse à verre • [IT] Trapano fissato su vetro • [ES] Fiksita pilko • [PT] Conjunto de broca de vidro

Art. No. 157115

EAN: 3800123169250

Ø 5-8mm

DRILLS 3 pcs: Ø5.0, 6.0, 8.0mm



## GLASS AND TILE DRILL BIT

[BG] Свредло за стъкло • [RO] Burghiu ptr sticlă • [SR] Burgija za staklo • [MK] Бургџија за стакло  
 • [RU] Сверло для стекла • [SL] Svedro za steklo • [EL] Τρυπάνι για ποτήρι • [HR] Svrđalo za staklo i keramike • [FR] Set de perceuse à verre • [IT] Trapano fissato su vetro • [ES] Fiksita pilko • [PT] Conjunto de broca de vidro

art. №	Ø (mm)	BARCODE
157763	Ø3	3800123169267
157764	Ø4	3800123169274
157765	Ø5	3800123169281
157766	Ø6	3800123169298
157767	Ø8	3800123169304
157768	Ø10	3800123169311
157769	Ø12	3800123169328





## ADAPTOR FROM SDS-MAX TO SDS-PLUS

[BG] Адаптер от SDS-max към SDS-plus • [RO] Adaptor de la SDS MAX-SDS PLUS • [SR] Adapter sa SDS- mak da SDS -plus • [MK] Адаптер • [RU] Адаптер с SDS-Max на SDS-Plus • [SL] Adapter iz SDS-max, da SDS-plus • [EL] Μετατροπέας SDS-max σε SDS-plus • [HR] SDS-MAX Adapter • [FR] Adaptateur avec SDS-Max à SDS-Plus • [IT] Adattatore con SDS-Max a SDS-Plus • [ES] Adaptilo kun SDS-Max al SDS-Plus • [PT] Adaptador com SDS-Max para SDS-Plus



Art. No. 159916  
EAN: 3800123141805



## HOLESAW ARBOR SDS-PLUS WITH PILOT MASONRY DRILL BIT

[BG] Водач SDS-plus за боркорона • [RO] Tijă conectoare SDS-PLUS • [SR] Vodilica za kruna • [MK] Водач за круна за бетон за торна SDS+ • [RU] Бур за Колонковая бур фреза • [SL] Vodič za krona za vrtanje betona • [EL] Οδηγός τρυπάνι SDS-plus • [HR] Nosač s svrdlom za centriranje • [FR] Couronne carbure pour béton SDS-plus • [IT] Corona per metallo duro per calcestruzzo SDS-plus • [ES] Krono por karburo por betono SDS-plus • [PT] Coroa de carboneto para betão SDS-plus

art. №	SDS	length	BARCODE
154811	plus	200	3800123102516
154805	plus	300	3800123122705
157801	plus	500	3800123162725
157802	max	500	3800123163777



## CARBIDE CORE CUTTER WITH HOLESAW ARBOR&PILOT MASONRY DRILL BIT

[BG] Боркорона за бетон с водач и сверло • [RO] Adaptor pentru freza cu miez din carbura [SR] Adapter rezač jezgre od karbida • [MK] Адаптер за сеченье карбид • [RU] Адаптер твердосплавный резак • [SL] Adapter rezkar za jedro iz karbida • [EL] Μετατροπέας καρβιδίου [HR] Rezač jezgre od karbidne jezgre • [FR] Fraise à noyau en carbure • [IT] AFresa in metallo duros • [ES] Karburilo kerna trancilo • [PT] Cortador de núcleo de metal duro

art. №	Ø (mm)	BARCODE
154812	Ø30	3800972016729
154813	Ø35	3800972016736
154814	Ø45	3800972016743
154815	Ø65	3800972016750
154816	Ø85	3800972016767
154817	Ø130	3800972016774

**NEW PRODUCT**



## CHISELS SDS-PLUS 3 PCS. SET

[BG] Длета SDS-plus 3 броя к-т • [RO] 3Pcs/Set dalti SDS • [SR] Sekači 3 kom Set SDS-plus • [MK] Длета SDS-plus 3 ком сет • [RU] Набор долота SDS плюс 3 шт. • [SL] Sekači 3 kos Set • [EL] Σετ SDS PLUS 3 τεμαχίων • [HR] SDS-Plus Dlijeto 3kom • [FR] SDS jeu de ciseaux SDS plus • [IT] Set di scalpelli SDS plus • [ES] SDS čizilo aro plus • [PT] Conjunto de cinzel SDS mais

Art. No. 159904  
EAN: 3800123125263



## HOLLOW GOUGING CHISEL SDS-PLUS

[BG] Длето-каналоконател SDS-plus • [RO] Dalta scobit SDS-PLUS • [SR] Sekač kanalni SDS-plus • [MK] Длето за канал • [RU] Долото SDS-PLUS • [SL] Dleto za kanal • [EL] Καλέμι αυλακώσεων SDS-Plus • [HR] Dlijeto za utore • [FR] Achat de SDS-PLUS • [IT] Scalpello scavato per scalpello SDS-plus • [ES] Hollow Gouging Chisel SDS-plus • [PT] Cinzel de cinzelamento oco SDS-plus

art. №	L1/ mm	D1/ mm	D2/ mm	BARCODE
154001	250	23	14	3800123125645
154002	250	23	17	3800123125645

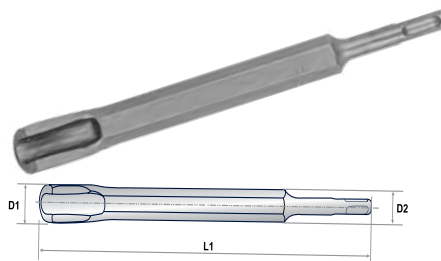

## TILE CHISEL SDS-PLUS

[BG] Длето-лопатка SDS-plus • [RO] Dalta lata SDS-plus • [SR] Sekač SDS-plus • [MK] Длето SDS-plus • [RU] Долото широкое SDS-PLUS • [SL] Dleto SDS-plus • [EL] Καλέμι διαβάθμισης • [HR] Široko dlijeto hex • [FR] SDS-PLUS burin large • [IT] Praticare un po 'di bit SDS-PLUS • [ES] SDS-PLUS larđa čizilo • [PT] Formão largo SDS-PLUS

art. №	L1/ mm	D1/ mm	D2/mm	BARCODE
154007	250	40	14	3800123159985
154008	250	40	14	3800972002524

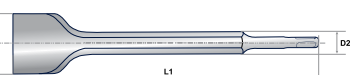
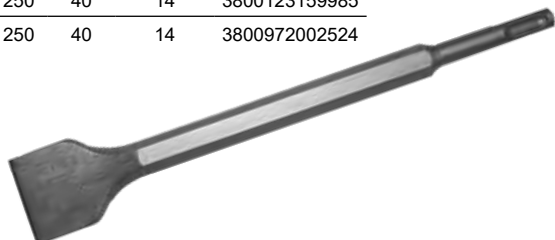

## FLAT CHISEL SDS-PLUS

[BG] Длето-сечак SDS-plus • [RO] Dalta SDS-PLUS • [SR] Sekač SDS-plus • [MK] Длето SDS-plus • [RU] Долото SDS-PLUS • [SL] Dleto SDS-plus • [EL] Καλέμι διαβάθμισης • [HR] Plosnato dlijeto • [FR] SDS-PLUS burin • [IT] Scalpello SDS-PLUS • [ES] SDS-PLUS čizilo • [PT] Formão SDS-PLUS

art. №	L1/ mm	D1/ mm	D2/mm	BARCODE
154003	250	20	14	3800123125638
154010	250	20	14	3800972005020
154004	250	23	17	3800123125669

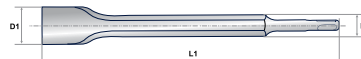
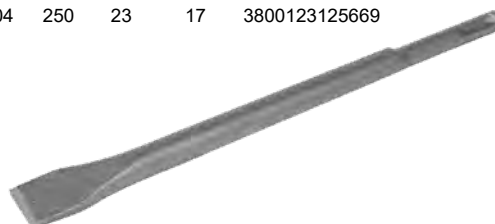

## POINT CHISEL SDS-PLUS

[BG] Длето-шило SDS-plus • [RO] Spit SDS-PLUS • [SR] Špic SDS-plus • [MK] Длето остро SDS-plus • [RU] Долото пика SDS-PLUS • [SL] Dleto konica SDS-plus • [EL] Βελόνη SDS-plus • [HR] Šiljato dljeto hex • [FR] Burin de pointe SDS-PLUS • [IT] Scalpello di punta SDS-PLUS • [ES] SDS-PLUS pinta čizilo • [PT] Bit de pico SDS-PLUS

art. №	L1/ mm	D1/ mm	BARCODE
154005	250	14	3800123125621
154009	250	14	3800972005013
154006	250	17	3800123125652

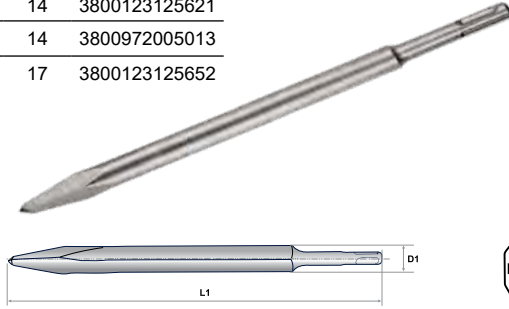

## TILE CHISEL SDS-MAX

[BG] Длето-лопатка SDS-max • [RO] Dalta lata SDS-max • [SR] Sekač SDS-max • [MK] Длето SDS-max • [RU] Долото широкое SDS-max • [SL] Dleto SDS-max • [EL] Καλέμι διαβάθμισης SDS-max • [HR] Široko dljeto • [FR] SDS-PLUS burin large • [IT] Praticare un po' di bit SDS-PLUS • [ES] SDS-PLUS larğa čizilo • [PT] Formão largo SDS-PLUS

Art. No. 154201  
EAN: 3800123145049

SDS  
max

L1: 300mm  
D1: 50mm  
D2: 18mm

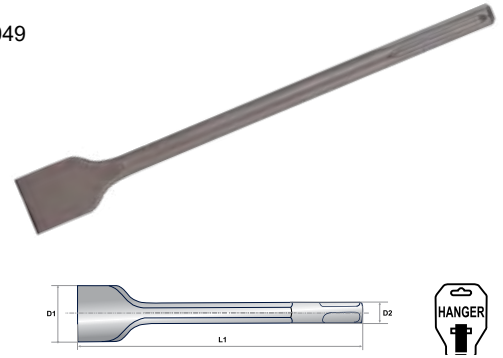

## FLAT CHISEL SDS-MAX

[BG] Длето-секач SDS-max • [RO] Dalta SDS-max • [SR] Sekač SDS-max • [MK] Длето SDS-max • [RU] Долото SDS-max • [SL] Dleto SDS-max • [EL] Καλέμι διαβάθμισης • [HR] Plosnato dljeto • [FR] SDS-max burin • [IT] Scalpello SDS-max • [ES] SDS-max čizilo • [PT] Formão SDS-max

Art. No. 154202  
EAN: 3800123145032

SDS  
max

L1: 400mm  
D1: 25mm  
D2: 18mm

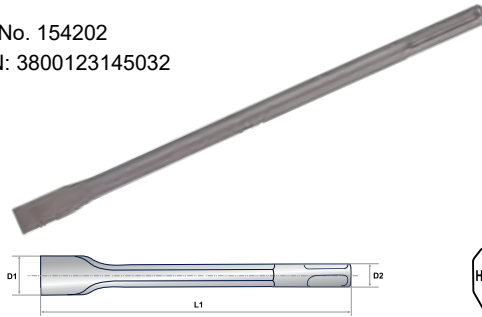

## POINT CHISEL SDS-MAX

[BG] Длето-шило SDS-max • [RO] Spit SDS-max • [SR] Špic SDS-max • [MK] Длето остро SDS-max • [RU] Долото пика SDS-max • [SL] Dleto konica SDS-max • [EL] βελόνη SDS-max • [HR] Šiljato dljeto • [FR] Le bit de pointe SDS-max • [IT] Scalpello di punta SDS-max • [ES] La pinta SDS-max • [PT] Pico SDS-max

Art. No. 154203  
EAN: 3800123145025

SDS  
max

L1: 400mm  
D1: 18mm

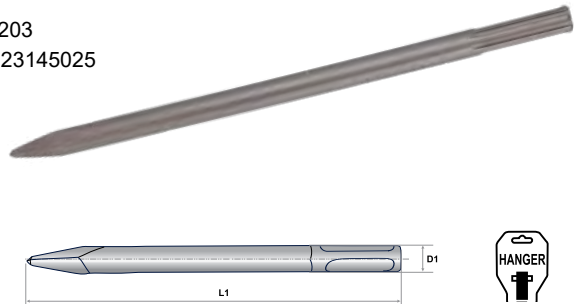

## HOLLOW GOUGING CHISEL

[BG] Длето-каналокопател SDS-max • [RO] Dalta pentru canale SDS-max • [SR] Šuplje dleto SDS-max • [MK] Длето остро SDS-max • [RU] Долото SDS-max • [SL] Dleto konica SDS-max • [EL] SDS-max σμίλη • [HR] Šiljato dljeto • [FR] Burin SDS-max • [IT] Scalpello SDS-max • [ES] SDS-max čizilo • [PT] Cinzel SDS-max

Art. No. 154206  
EAN: 3800972016064

SDS  
max

L1: 250mm  
D1: 25mm  
D2: 18mm



## POINT CHISEL SDS-MAX

[BG] Длето-шило SDS-max • [RO] Spit SDS-max • [SR] Špic SDS-max • [MK] Длето остро SDS-max • [RU] Долото пика SDS-max • [SL] Dleto konica SDS-max • [EL] βελόνη SDS-max • [HR] Šiljato dljeto • [FR] Le bit de pointe SDS-max • [IT] Scalpello di punta SDS-max • [ES] La pinta SDS-max • [PT] Pico SDS-max

Art. No. 154205  
EAN: 3800972009028

SDS  
max

L1: 600mm  
D1: 18mm



## FLAT CHISEL SDS-MAX

[BG] Длето-секач SDS-max • [RO] Dalta SDS-max • [SR] Sekač SDS-max • [MK] Длето SDS-max • [RU] Долото SDS-max • [SL] Dleto SDS-max • [EL] Καλέμι διαβάθμισης • [HR] Plosnato dljeto • [FR] SDS-max burin • [IT] Scalpello SDS-max • [ES] SDS-max čizilo • [PT] Formão SDS-max

Art. No. 154204  
EAN: 3800972009011

SDS  
max

L1: 600mm  
D1: 25mm  
D2: 18mm

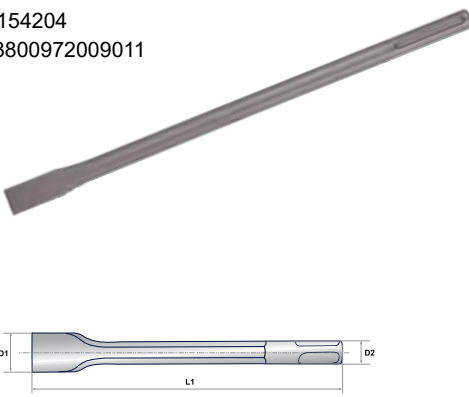

## HAMMER DRILL BITS SDS-PLUS 5 PCS SET

[BG] Средна SDS-plus 5 бр. комплект • [RO] 5Pcs/Set burghie SDS-PLUS • [SR] Burgija za zid SDS-plus Set 5 kom • [MK] Бургџија SDS-plus сет 5 ком • [RU] Сверло по бетону SDS-plus набор 5 шт • [SL] Sveder za beton SDS-plus nabor 5 kos • [EL] τρυπάνι για το σκυρόδεμα SDS-plus сет 5 τεμαχίων • [HR] Svrdla za zidove SDS-plus 5kom • [FR] Foret à béton SDS-plus • [IT] Punta per calcestruzzo SDS-plus • [ES] Drilo por concreto SDS-plus • [PT] Broca para betão SDS-plus

Ø 5-10mm

DRILLS 5 pcs:  
Ø10, 12, 16, 19, 22, 25, 32mm

Art. No. 158101  
EAN: 3800123125591

5 pcs

SDS+

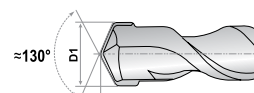



**HAMMER DRILL BIT SDS-MAX**

[BG] Свърделно SDS-max • [RO] Burghie beton SDS-max • [SR] Burgija za zid SDS-max • [MK] Буриџа за ѕид SDS-max • [RU] Свърло по бетону SDS-max • [SL] Sveder za beton SDS-max • [EL] Τρυπάνι για το σκυρόδεμα SDS-max • [HR] Svrđlo za zidove SDS-max • [FR] Foret à béton SDS-max • [IT] Trapano per calcestruzzo SDS-max • [ES] SDS-max Konkreta Borilo • [PT] Broca de concreto SDS-max

art. №	D1 (mm)	L1 (mm)	L2 (mm)	BARCODE
153802	Ø10	260	130	3800123125942
153803	Ø12	260	130	3800123125959
153804	Ø16	400	270	3800123125966
153805	Ø20	400	270	3800123125973
153806	Ø22	505	370	3800123125980
153807	Ø25	600	470	3800123125997
153801	Ø32	600	470	3800123145018
153808	Ø12	400	290	3800972010468
153809	Ø14	400	290	3800972010475
153810	Ø16	600	490	3800972010482
153811	Ø16	1000	890	3800972010499
153812	Ø18	600	490	3800972010505
153813	Ø18	1000	890	3800972010512
153814	Ø20	600	490	3800972010529
153815	Ø20	1000	890	3800972010536
153816	Ø22	1000	890	3800972010543
153817	Ø25	1000	890	3800972010550
153818	Ø25	1000	490	3800972010567
153819	Ø30	600	890	3800972010574
153820	Ø35	1000	890	3800972010581

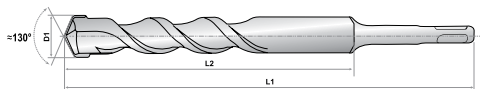

**HAMMER DRILL BIT SDS-PLUS**

[BG] Свърделно SDS-plus • [RO] Burghie beton SDS-plus • [SR] Burgija za zid SDS-plus • [MK] Буриџа SDS-plus • [RU] Свърло по бетону SDS-plus • [SL] Sveder za beton SDS-plus • [EL] Τρυπάνι για το σκυρόδεμα SDS-plus • [HR] Svrđlo za zidove SDS-plus • [FR] Foret à béton SDS-max • [IT] Trapano per calcestruzzo SDS-max • [ES] SDS-max Konkreta Borilo • [PT] Broca de concreto SDS-max

art. №	D1 (mm)	L1 (mm)	L2 (mm)	BARCODE
159910	4	110	50	3800123150159
153630	5	110	50	3800123160165
153629	5	160	100	3800123160158
153634	5	210	150	3800123160219
153631	6	110	50	3800123160172
153601	6	160	100	3800123125447
153602	6	210	150	3800123125454
153632	8	110	50	3800123160189
153616	8	160	100	3800123160028
153603	8	210	150	3800123125478
153604	8	260	200	3800123125461
153617	8	350	300	3800123160035
153652	8	450	400	3800123160615
153633	10	110	50	3800123160196
153605	10	160	100	3800123125485
153606	10	210	150	3800123125492
153618	10	260	200	3800123160042
153607	10	310	250	3800123125508
153619	10	350	300	3800123160059
153620	10	460	400	3800123160066
153621	12	160	100	3800123160073
153608	12	210	150	3800123125515
153609	12	310	250	3800123125522
153622	12	350	300	3800123160080
153623	12	450	400	3800123160097
153624	14	160	100	3800123160103
153635	14	210	150	3800123160226
153636	14	260	200	3800123160233
153653	14	310	250	3800123160622
153625	14	350	300	3800123160110
153610	14	450	400	3800123125539
153638	16	160	100	3800123160257
153639	16	210	150	3800123160264
153651	16	300	250	3800123160608
153626	16	350	300	3800123160127
153611	16	450	400	3800123125546
153640	18	210	150	3800123160271
153627	18	350	300	3800123160134
153612	18	450	400	3800123125553
153628	20	350	300	3800123160141
153613	20	450	400	3800123125560
153614	22	450	400	3800123125577
153646	24	450	400	3800123160332
153615	26	450	400	3800123125584
153647	28	450	400	3800123160349
153648	30	450	400	3800123160356
153649	32	450	400	3800123160363
153682	14	1000	950	3800972010598
153683	18	1000	950	3800972010604
153684	22	1000	950	3800972010611
153685	30	1000	950	3800972010628
153686	32	1000	950	3800972010635

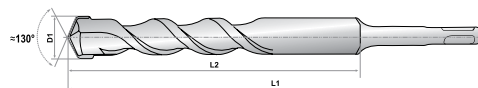

**HAMMER DRILL BIT CROSS HEAD SDS-PLUS**

[BG] Свърделно Cross Head SDS-plus • [RO] Burghie beton Cross Head SDS-plus • [SR] Burgija za zid Cross Head SDS-plus • [MK] Буриџа Cross Head SDS-plus • [RU] Свърло по бетону Cross Head SDS-plus • [SL] Sveder za beton SDS-plus • [EL] Τρυπάνι για το σκυρόδεμα SDS-plus • [HR] Svrđlo za zidove SDS-plus 4-Plus • [FR] Foret à béton Cross Head SDS-plus • [IT] Trapano per calcestruzzo Cross Head SDS-plus • [ES] Cross Head SDS-plus Konkreta Borilo • [PT] Broca de concreto Cross Head SDS-plus

art. №	D1 (mm)	L1 (mm)	L2 (mm)	BARCODE
153656	6	110	50	3800123151255
153657	6	160	100	3800123151262
153658	6	210	150	3800123151279
153659	6.5	260	200	3800123151286
153660	8	110	50	3800123151293
153661	8	160	100	3800123151309
153662	8	210	150	3800123151316
153663	8	260	200	3800123151323
153664	8	350	300	3800123151330
153665	10	160	100	3800123151347
153666	10	210	150	3800123151354
153667	10	260	200	3800123151361
153668	10	350	300	3800123151378
153669	10	450	400	3800123151385
153670	12	210	150	3800123151392
153671	12	350	300	3800123151408
153672	12	450	400	3800123151415
153673	14	160	100	3800123151422
153674	14	210	150	3800123151439
153675	14	260	200	3800123151446
153676	14	350	300	3800123151453
153677	14	450	400	3800123151460
153678	16	260	210	3800972003156
153679	18	260	210	3800972003163
153680	20	260	210	3800972003170
153681	24	260	210	3800972003187

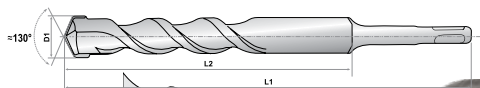

## SHEET METAL HOLESAW WITH PILOT HSS DRILL BIT

[BG] Боркорона за ламарина с водач HSS • [RO] Freza gaurire HSS • [SR] Krunska glava za bušenje HSS • [MK] Круна за лим са бургија HSS • [RU] Биметаллическая коронка резки листового металла HSS • [SL] Kronska žaga za pločevina HSS • [EL] Κορώνα για την κοπή λαμαρίνας • [HR] Kruga za lim s vodič HSS • [FR] Tôle de coupe de couronne bimétallique HSS • [IT] Lamiera di metallo a corona bimetallica HSS • [ES] Bimetala krono tranča metalo HSS • [PT] Chapa de corte bimetálica HSS

art. №	Ø / mm	BARCODE
154801	25	3800123160424
154802	35	3800123160431



## ADJUSTABLE HOLE CUTTER UP TO Ø120MM FOR WOOD

[BG] Боркорона за дърво до Ø120mm • [RO] Freza lemn reglabila-pana la 120mm • [SR] Krunska glava za bušenje • [MK] Круна за дрво • [RU] Набор коронка для древо • [SL] Kronska žaga za les • [EL] Κορώνα για την κοπή ξύλο • [HR] Kruga za drvo • [FR] Couronne sertie de bois • [IT] Corona per legno • [ES] Krono starigita por ligno • [PT] Coroa para madeira

Art. No. 157703  
EAN: 3800123121579

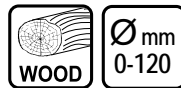

## HOLESAW Ø54MM AND DRILL BIT Ø22MM KIT

[BG] Боркорона Ø54mm и сверделно Ø22mm за дърво к-т • [RO] Set carota 54mm si burghiu pentru lemn 22mm • [SR] Krunska glava za bušenje i burgija za drvo set • [MK] Круна и Бургија за дрво Set • [RU] Биметаллическая коронка и Сверло для древо набор • [SL] Kronska žaga za les in sveder nastav • [EL] Κορώνα για την κοπή ξύλο & Τρυπάνι Σετ • [HR] Kruga i Svrdlo za drvo • [FR] Couronne bimétallique et foret pour jeu de bois • [IT] Corona bimetallica e punta per legno • [ES] Bimetala krono kaj taladro bito por ligno aro • [PT] Coroa bimetálica e broca para madeira

Ø54mm

Ø22mm

Art. No. 157701  
EAN: 3800123121180



## HOLE CUTTERS Ø19-127MM 16 PCS KIT FOR WOOD

[BG] Боркорони 16 части комплект • [RO] 16Pcs/Set Freza gaurire • [SR] Krunska glava za bušenje na drvo 16kom • [MK] Круна за дрво 16ком • [RU] Набор Коронка для древо 16 шт • [SL] Kronska žaga za les 16 kos • [EL] Κορώνα για την κοπή ξύλο 16 τεμ • [HR] 16-djelni set Krunske pile • [FR] Set Crown pour l'arbre • [IT] Imposta la corona per l'albero • [ES] Fiksu Kronon por la arbo • [PT] Definir coroa para a árvore

Ø 19-127mm  
HOLE CUTTERS:  
Ø19, 22, 29, 32, 38, 44, 51, 64,  
76, 89, 102, 127 mm  
Art. No. 157710  
EAN: 3800123126000



## HOLE CUTTERS Ø19-64MM 11 PCS KIT FOR WOOD

[BG] Боркорони 11 части комплект • [RO] 11Pcs/Set Freza gaurire • [SR] Krunska glava za bušenje na drvo 11 kom • [MK] Круна за дрво 11ком • [RU] Набор Коронка для древо 11 шт • [SL] Kronska žaga za les 11 kos • [EL] Κορώνα για την κοπή ξύλο 11 τεμ • [HR] 11-djelni set Krunske pile • [FR] Set Crown pour l'arbre • [IT] Imposta la corona per l'albero • [ES] Fiksu Kronon por la arbo • [PT] Definir coroa para a árvore

Ø 19-64mm  
HOLE CUTTERS: Ø19, 22, 29, 32, 38, 44, 51, 64 mm  
HOLESAWS:  
Ø33, 53, 67, 73, 83mm

Art. No. 157707  
EAN: 3800123121203



## HOLE CUTTERS Ø26-63MM 7 PCS KIT FOR WOOD

[BG] Боркорони 7 части комплект • [RO] 7Pcs/Set Freza gaurire • [SR] Krunska glava za bušenje na drvo 7 kom • [MK] Круна за дрво 7 ком • [RU] Набор Коронка для древо 7 шт • [SL] Kronska žaga za les 7 kos • [EL] Κορώνα για την κοπή ξύλο 7 τεμ • [HR] 7-djelni set Krunske pile • [FR] Set Crown pour l'arbre • [IT] Imposta la corona per l'albero • [ES] Fiksu Kronon por la arbo • [PT] Definir coroa para a árvore

Ø 26-63mm 2"  
HOLE CUTTERS:  
Ø26, 32, 38, 45, 50, 56, 63 mm  
Art. No. 157704  
EAN: 3800123121197



## BI-METAL HOLESAWS Ø22-64MM 9PCS KIT

[BG] Боркорони биметални 9 части комплект • [RO] 9Pcs/Set freze gaurire • [SR] Krunska glava za bušenje set 9kom • [MK] Круна за дрво 9ком • [RU] Набор Биметаллическая Коронка 9 шт • [SL] Kronska žaga 9 kos • [EL] Κορώνα για την κοπή ξύλο 9 τεμ • [HR] 9-djelni set Krunske pile Bi-Metal • [FR] Ensemble de couronne bimétallique • [IT] Set corona bimetallica • [ES] Bimetala Krono • [PT] Conjunto de coroa bimetálica

Ø 22-64mm  
HOLESAWS:  
Ø22, 35, 38, 44, 51, 64 mm  
Art. No. 157712  
EAN: 3800123160011



## HOLESAW ARBOR WITH PILOT MASONRY DRILL BIT

[BG] Водач за би-метални боркорони с центриращо сверделно • [RO] Burghiu de centrare cu zencuitor • [SR] Vodilica za kruga sa burgija za centriranje • [MK] Водач за круна со центрирање вежба малку • [RU] Бур за Колонковая бур фреза • [SL] Vodič za kruga + sveder za centriranje • [EL] Οδηγός τρυπάνι • [HR] Adapter sa centrir svrdlom za krune • [FR] Fraise pour perceuse Kolonkovaya • [IT] Guida di perforazione • [ES] Borado Gvidilo • [PT] Guia de perfuração

Art. No. 157800  
EAN: 3800123170065  
1/2" (12.5 mm)  
for Bi-Metal Holesaws Ø14-30mm



## ADJUSTABLE HOLE CUTTER UP TO Ø90MM FOR TILES

[BG] Сверделно за плочки • [RO] Dispositiv taiera circulara reglabil pana la 90mm • [SR] Burgija za bušenje na pločice • [MK] Бургија за плочки • [RU] Сверло для плитки • [SL] Sveder za keramične ploščice • [EL] Τρυπάνι για την κοπή κεραμικά πλακίδια • [HR] Svrdlo za pločice • [FR] Perceuse • [IT] Trapano per piastrelle • [ES] Tile taladro • [PT] Broca de telha

Ø0-90mm

Art. No. 159908  
EAN: 3800123116490

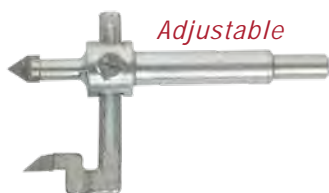

## HOLESAW ARBOR WITH PILOT MASONRY DRILL BIT

[BG] Водач за би-метални боркорони с центриращо сверделно • [RO] Burghiu de centrare cu zencuitor • [SR] Vodilica za kruga sa burgija za centriranje • [MK] Водач за круна со центрирање вежба малку • [RU] Бур за Колонковая бур фреза • [SL] Vodič za kruga + sveder za centriranje • [EL] Οδηγός τρυπάνι • [HR] Adapter sa centrir svrdlom za krune • [FR] Fraise pour perceuse Kolonkovaya • [IT] Guida di perforazione • [ES] Borado Gvidilo • [PT] Guia de perfuração

5/8" (16 mm) for Bi-Metal Holesaws Ø32-200mm  
Art. No. 157757  
EAN: 3800123169199





## HSS BI-METAL HOLESAW

[BG] Боркорона HSS bi-metal • [RO] Freze gaurire HSS bi-metal • [SR] Krunska glava za bušenje HSS bi-metal • [MK] Круна за дрво HSS bi-metal • [RU] Биметаллическая Коронка HSS bi-metal • [SL] Kronska žaga HSS bi-metal • [EL] Κορώνα για την κοπή ξύλο HSS bi-metal • [HR] Krunska svrdla HSS bi-metal • [FR] Couronne bimétallique HSS bi-métal • [IT] Bimetallic Crown HSS bi-metal • [ES] Bimetala Krono HSS bi-metal • [PT] Bimetálico Crown HSS bimetalico

art. №	Ø (mm)	BARCODE
157746	Ø20	3800123169083
157786	Ø22	3800123169496
157747	Ø25	3800123169090
157787	Ø30	3800123169502
157748	Ø32	3800123169106
157749	Ø35	3800123169113
157788	Ø40	3800123169519
157750	Ø44	3800123169120
157751	Ø51	3800123169137
157752	Ø57	3800123169144
157753	Ø65	3800123169151
157754	Ø68	3800123169168
157755	Ø76	3800123169175
157756	Ø83	3800123169182

Ø 20-83mm



## HSS BI-METAL HOLESAW 8% CO

[BG] Боркорона HSS bi-metal 8% Co • [RO] Freze gaurire HSS bi-metal 8% Co • [SR] Krunska glava za bušenje HSS bi-metal 8% Co • [MK] Круна за дрво HSS bi-metal 8% Co • [RU] Биметаллическая Коронка HSS bi-metal 8% Co • [SL] Kronska žaga HSS bi-metal 8% Co • [EL] Κορώνα για την κοπή ξύλο HSS bi-metal 8% Co • [HR] Krunska svrdla HSS bi-metal 8% Co • [FR] Couronne bimétallique HSS bi-métal 8% Co • [IT] Corona bimetallica HSS bi-metallo 8% Co • [ES] Bimetala Krono HSS bi-metallo 8% Co • [PT] Coroa bimetalica HSS bimetalica 8% Co

Ø 20-83mm

art. №	Ø (mm)	BARCODE
157820	Ø20	3800123173080
157821	Ø22	3800123173097
157822	Ø25	3800123173103
157823	Ø30	3800123173110
157824	Ø32	3800123173127
157825	Ø35	3800123173134
157826	Ø40	3800123173141
157827	Ø44	3800123173158
157828	Ø51	3800123173165
157829	Ø57	3800123173172
157830	Ø65	3800123173189
157831	Ø67	3800123173196
157832	Ø76	3800123173219
157833	Ø83	3800123173226



## CARBIDE HOLESAW ARBOR

[BG] Водач за Carbide боркорони • [RO] Arbore pentru carote Carbide • [SR] Vodilica za kruna Carbide • [MK] Водач за круна Carbide • [RU] Центрирующий бур для буровые коронки • [SL] Vodič za krona Carbide • [EL] Ποτηροτύπανο ξύλου • [HR] Adapter za krune Carbide • [FR] Déchiqueteuse de bois • [IT] Cippatrice • [ES] Cifona ligno • [PT] Triturador de madeira

Ø 33-103mm

Art. No. 157762  
EAN: 3800123169243



CARBIDE



CARBIDE



## HOLESAW FOR CERAMICS Ø33-83MM 7PCS KIT

[BG] Боркорони за керамични плочки 7 части комплект • [RO] Set carote pentru placi ceramice • [SR] Krunska glava za bušenje na pločice 7 kom • [MK] Круна за плочки 7 ком • [RU] Набор Коронка для плитки 7 шт • [SL] Kronska žaga za keramične ploščice 7 kos • [EL] Κορώνα για την κοπή κεραμικά πλακίδια 7 τεμ • [HR] 7-djelni set Krunske pile za keramičke pločice • [FR] Set Crown pour tuiles • [IT] Imposta la corona per le tessere • [ES] Fiksita Krono por kaheloj • [PT] Definir coroa para telhas

Ø 33-83mm CARBIDE

HOLESAWS: Ø22, 35, 38, 44, 51, 64 mm

Art. No. 157714

EAN: 3800123115783



## PILOT MASONRY DRILL BIT

[BG] Центриращо сверло за водач за bi-метални боркорони • [RO] Burghiu de centrare • [SR] Burgija za centriranje • [MK] Центрирање вежба • [RU] Центрирующее Сверло • [SL] Sveder za centriranje • [EL] Ποτηροτύπανο ξύλου • [HR] Centrir svrdlom za krune • [FR] Foret de centrage • [IT] Centratore Drill • [ES] Centri Drill • [PT] Broca de Centralização

Art. No. 157804

EAN: 3800123173660



## COBALT PILOT DRILL BIT FOR BI-METAL HOLESAWS

[BG] Центриращо сверло Co за водач за bi-метални боркорони • [RO] Burghiu de centrare Co • [SR] Burgija za centriranje Co • [MK] Центрирање вежба Co • [RU] Центрирующее Сверло Co • [SL] Sveder za centriranje Co • [EL] Ποτηροτύπανο ξύλου Co • [HR] Centrir svrdlom Co za krune • [FR] Foret de centrage • [IT] Centratore Drill • [ES] Centri Drill • [PT] Broca de Centralização

Art. No. 157837

EAN: 3800972002043



## TUNGSTEN CARBIDE TIPPED HOLE SAW

[BG] Боркорона Carbide • [RO] Freze gaurire Carbide • [SR] Krunska glava za bušenje Carbide • [MK] Круна за дрво Carbide • [RU] Коронка Carbide • [SL] Kronska žaga Carbide • [EL] Κορώνα για την κοπή Carbide • [HR] Krunska svrdla Carbide • [FR] Couronne pour couper le carbure • [IT] Corona per taglio di carburo • [ES] Krono por trançado Carbide • [PT] Coroa para corte de carboneto

art. №	Ø (mm)	BARCODE
157758	Ø33	3800123169205
157759	Ø43	3800123169212
157770	Ø53	3800123169335
157760	Ø67	3800123169229
157771	Ø73	3800123169342
157772	Ø83	3800123169359
157773	Ø103	3800123169366



Ø 33-103mm

CARBIDE

## PILOT MASONRY DRILL BIT

[BG] Центриращо сверло за водач за Carbide боркорони • [RO] Burghiu de centrare • [SR] Burgija za centriranje • [MK] Центрирање вежба • [RU] Центрирующее Сверло • [SL] Sveder za centriranje • [EL] Ποτηροτύπανο ξύλου • [HR] Centrir svrdlom za krune • [FR] Foret de centrage • [IT] Centratore Drill • [ES] Centri Drill • [PT] Broca de Centralização

Art. No. 157803

EAN: 3800123173479



CARBIDE



## DIAMOND COATED HOLE SAW

[BG] Боркорона Diamond • [RO] Freze gaurire Diamond • [SR] Krunska glava za bušenje Diamond • [MK] Круна за дрво Diamond • [RU] Коронка Diamond • [SL] Kronska žaga Diamond • [EL] Κορώνα για την κοπή Diamond • [HR] Dijamantna krunska svrdla • [FR] Borkorona Diamond • [IT] Borkorona Diamond • [ES] Borkorona Diamond • [PT] Borkorona Diamond

Ø6-76mm

art. №	Ø mm	BARCODE
157774	Ø6	3800123169373
157775	Ø8	3800123169380
157776	Ø10	3800123169397
157777	Ø12	3800123169403
157778	Ø25 (1")	3800123169410
157779	Ø30 (1 1/8")	3800123169427
157780	Ø35 (1 3/8")	3800123169434
157781	Ø44 (1 3/4")	3800123169441
157782	Ø51 (2")	3800123169458
157783	Ø68	3800123169465
157784	Ø76 (3")	3800123169472

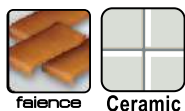

## DRILL GUIDE HOLDER FOR DIAMOND COATED HOLE SAWS

[BG] Водач за диамантени боркорони • [RO] Ghid pentru carote diamantate • [SR] Vodič za dijaminske krune za bušenje • [MK] Водич за дијамантски боркорони • [RU] Руководство по алмазным коронкам • [SL] Vodnik za diamantne vrtnalnice • [EL] Οδηγός για ποτηροκωρώνες με διαμάντι • [HR] Vodič za dijamantnim bušaćim krunama • [FR] Guide pour les fraises diamantées • [IT] Guida per corone diamantate • [ES] Guía para los cortadores de base del diamante • [PT] Guia para cortadores de núcleo do diamante

Ø4-83mm

Art. No. 157711

EAN: 3800972002401



## DIAMOND DRY HOLE SAW

[BG] Боркорона Diamond Dry • [RO] Carote diamantate pentru gaurire uscata • [SR] Krunska glava za bušenje diamond Dry • [MK] Круна за дрво Diamond Dry • [RU] Коронка Diamond Dry • [SL] Kronska žaga Diamond Dry • [EL] Κορώνα για την κοπή Diamond Dry • [HR] Dijamantna krunska svrdla Dry • [FR] Borkorona Diamond Dry • [IT] Borkorona Diamond Dry • [ES] Borkorona Diamond Dry • [PT] Borkorona Diamond Dry

Ø6-65mm

M14

FOR ANGLE GRINDER

**NEW  
PRODUCT**

art. №	Ø mm	BARCODE
157838	Ø6	3800972014794
157839	Ø8	3800972014800
157840	Ø10	3800972014817
157841	Ø12	3800972014824
157842	Ø18	3800972014831
157843	Ø20	3800972014848
157844	Ø22	3800972014855
157845	Ø25	3800972014862
157846	Ø30	3800972014879
157847	Ø35	3800972014886
157848	Ø40	3800972014893
157849	Ø50	3800972014909
157850	Ø65	3800972014916

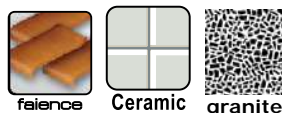

## HINGE HOLE CUTTER

[BG] Фрезер за отвор • [RO] Freza ptr balamale • [SR] Glodalo • [MK] Глодал • [RU] Зенкер для пробок • [SL] Rezar za luknjo • [EL] Φρεζών • [HR] Glodalo za utore, bočna • [FR] Charnière trou cutter • [IT] Cerniera per cerniere • [ES] Hinge Hole Cutter • [PT] Cortador De Furo De Dobradiça

art. №	D1 (mm)	BARCODE
154601	Ø15	3800123121258
154602	Ø20	3800123121265
154603	Ø25	3800123121272
154604	Ø30	3800123121289
154605	Ø35	3800123121296
154606	Ø40	3800123121302



## HINGE CUTTING BITS TUNGSTEN CARBIDE TIPPED 5 PCS SET

[BG] Фрезери за отвори с твърдосплавни пластини Ø15,20,25,30 и 35mm 5бр. к-т • [RO] 5 Pcs/Set freze ptr balamale • [SR] Glodala set 5 kom • [MK] Глодалки сет 5 ком • [RU] Зенкеры для пробок набор 5 шт • [SL] Rezar za luknjo 5 kos • [EL] Σετ φρεζών 5 τεμ • [HR] 5-djelni set glodala • [FR] Charnière trou cutter • [IT] Cerniera per cerniere • [ES] Hinge Hole Cutter • [PT] Cortador De Furo De Dobradiça

Ø15-35mm

CUTTERS D1:Ø15, 20, 25, 30, 35mm

Art. No. 157502

EAN: 3800123121210







## ROUTER BIT

[BG] Фрезер за обертфреза • [RO] Freza profilata • [SR] Glodalo • [MK] Глодало • [RU] Зенкер • [SL] Režkar • [EL] Φρεζών • [HR] Glodalo za utore, bočna / ravna  
 • [FR] Peu de routeur • [IT] Bit del router • [ES] Router Bito • [PT] Bit Router

art. №	D2 Ø mm	D1/mm	H/mm	BARCODE
154405	Ø 9.5	Ø 8	38	3800123169700
154402	Ø 12.7	Ø 8	25	3800123121531
154406	Ø 12.7	Ø 8	50.8	3800123169717

**WOOD**

art. №	D2 Ø mm	D1/mm	H/mm	BARCODE
154401	Ø 15.9	Ø 8	20	3800123121548

**WOOD**

art. №	D2 Ø mm	D1/mm	H/mm	BARCODE
154409	Ø 31.75	Ø 8	6.35	3800123169748

**WOOD**

art. №	D2 Ø mm	D1/mm	R/mm	B/mm	H/mm	BARCODE
154407	Ø 17.46	Ø 8	2.38	2.38	6.5	3800123169724

**WOOD**

art. №	D2 Ø mm	D1/mm	R/mm	B/mm	H/mm	BARCODE
154404	Ø 25.7	Ø 8	6.35	6.35	9.52	3800123121524

**WOOD**

**HANGER**

art. №	Ø mm	D1/mm	D2/mm	R/mm	B/mm	H/mm	BARCODE
154408	Ø 31.7	Ø 8	31.7	9.52	9.52	15.9	3800123169731

**WOOD**

**HANGER**

## ROUTER BIT

[BG] Фрезер за обертфреза • [RO] Freza profilata • [SR] Glodalno • [MK] Глодало • [RU] Зенкер • [SL] Režkar • [EL] Φρεζων • [HR] Glodalno za utore, bočna / ravna • [FR] Peu de routeur • [IT] Bit del router • [ES] Router Bito • [PT] Bit Router

art. №	D2 Ø mm	D1/mm	B/mm	BARCODE
154403	Ø 30.96	8	12.7	3800123121555

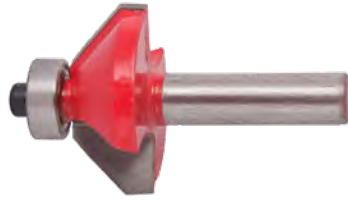
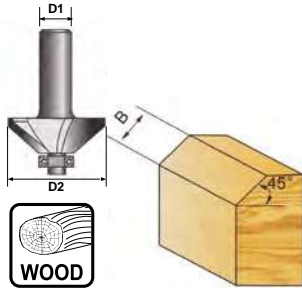

art. №	D1 Ø mm	BARCODE
158301	Ø 8	3800123121500

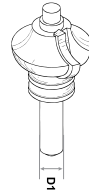

art. №	Ø D1/mm	BARCODE
158302	8	3800123121517

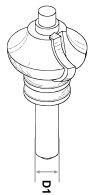

art. №	Ø D1/mm	BARCODE
158303	8	3800123121630

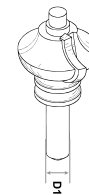

art. №	Ø D1/mm	BARCODE
158304	8	3800123121241

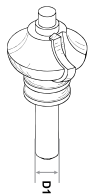

art. №	Ø D1/mm	BARCODE
158305	8	3800123121678

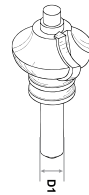

## JIGSAW BLADE FOR WOOD "T" SHANK 2 PCS SET

[BG] Нож За Прободен Трион За Дърво "Т" 2 Бр. Комплект • [RO] Rezerve Ferestaru Pendular - 2Buc/Set • [SR] List Testere Za Ubodna Testera Set 2 Kom • [MK] Нож За Убодна Пила Set 2 Ком • [RU] Пильное Полотно Для Сабельных Пил Набор 2шт • [SL] Žagin List 2 kos • [EL] Πριονόλαμης Σέτας Set 2 τεμ • [HR] Listovi pile za drvo • [FR] Lame de scie pour scie sabre, lot de 2 • [IT] Seghetto per seghe a sciabola Set di 2 pezzi • [ES] Vidita Klingo Por Scianta Saüco Aro de 2pcs • [PT] Lámina de serra para sabre Serras Conjunto de 2pcs

art. №	step mm	L1/mm	L2/mm	pcs	BARCODE	
155401	RD-WT119BC	2	76	50	2	3800123164101
154402	RD-WT111C	3	100	75	2	3800123164118
154403	RD-WT144D	4	100	75	2	3800123164125
155404	RD-WT244DS	4	100	75	2	3800123164132
155405	RD-WT344D	4	132	110	2	3800123164149
155406	RD-WT101AO	1.4	76	50	2	3800123164156
155407	RD-WT101B	2.5	100	75	2	3800123164163
155408	RD-WT101BR	2.5	100	75	2	3800123164170
155409	RD-WT 101D	4	100	75	2	3800123164187
155410	RD-WT301CD	3	116	90	2	3800123164194
155418*	RD-WT344CB	3	116	90	2	3800972009691
155419**	RD-WT744D	4	180	155	2	3800972009707



\* Art. No. 155418

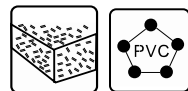

\*\* Art. No. 155419

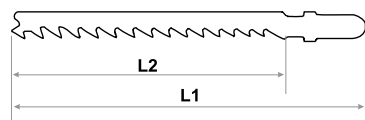



## JIGSAW BLADE CARBIDE "T" SHANK

[BG] Нож За Прободен Трион Carbide "T" • [RO] Rezerve Ferestaru Pendular - Carbide "T" • [SR] List Testere Za Ubodna Testera Carbide "T" • [MK] Нож За Убодна Пила Carbide "T" • [RU] Пильное Полотно Для Сабельных Пил Carbide "T" • [SL] Žagin List Carbide "T" • [EL] Приονόλαμες σέγας Carbide "T" • [HR] Listovi pile za metal Carbide "T" • [FR] Ensemble Carbide "T" [IT] Seghetto Carbide "T" • [ES] Vidita Carbide "T" • [PT] Lâmina Carbide "T"

art. №	mm	L1/mm	L2/mm	pcs	BARCODE
155417 RD-CT141HM	4.3	100	75	2	3800972009684

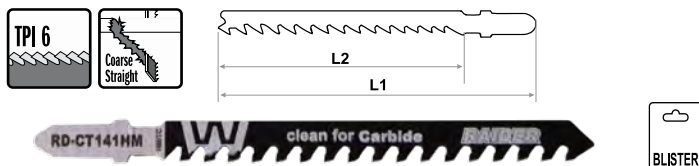

## JIGSAW BLADE FOR METAL "T" SHANK

[BG] Нож За Прободен Трион За Метал "Т" 2 Бр. Комплект • [RO] Rezerve Ferestaru Pendular - 2Buc/Set • [SR] List Testere Za Ubodna Testera Set 2 Kom • [MK] Нож За Убодна Пила Set 2 Ком • [RU] Пильное Полотно Для Сабельных Пил Набор 2шт • [SL] Žagin List 2 kos • [EL] Приονόλαμες σέγας Set 2 τεμ • [HR] Listovi pile za metal • [FR] Ensemble de 2 lames de scie sauteuse pour tige en "T" en métal • [IT] Seghetto per seghe a sciabola Set di 2 pezzi • [ES] Vidita Klingo Por Sciata Saüco Aro de 2pcs • [PT] Lâmina de serra para sabre Serras Conjunto de 2pcs

art. №	mm	L1/mm	L2/mm	pcs	BARCODE
155411 RD-MT118G	0.8	76	50	2	3800123164200
154412 RD-MT118A	1.2	76	50	2	3800123164217

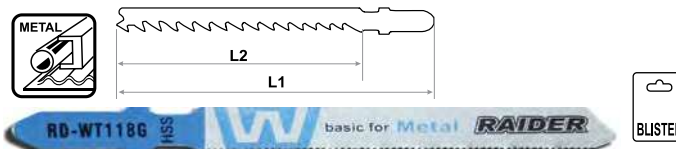

## ASSORTED JIGSAW BLADES "T" SHANK SET

[BG] Нож За Прободен Трион за дърво & метал "Т" • [RO] Rezerve ferestaru pendular set • [SR] List testere za ubodna testera set • [MK] Нож за убодна пила сет • [RU] Пильное полотно для сабельных пил набор • [SL] žagin list • [EL] Приονόλαμες σέγας Set • [HR] Listovi pile • [FR] Lame de scie pour scie sabre sets • [IT] Lama per sega a sciabola set • [ES] Širita klingo por sabročambroj starigis 5 komputilojn • [PT] Lâmina de serra para serras de sabre com

art. №	models	pcs	BARCODE
155413	T119BO, T144D, T101B, T111C, T118A	5	3800123164224
154414	T19BO 2pcs.; T144D 2pcs.; T101B2pcs.; T111C 2pcs., T118A 1pcs.; T118G 1pcs.	10	3800123164231
155416	T119BO 2pcs.; T144D 2pcs.; T101B 2pcs.; T123X 1pcs. T111C 2pcs., T118A 2pcs.; T118B 3pcs.; T101BR 2pcs.	16	3800972009677



## JIGSAW BLADES "T" SHANK 5 PCS. SET

[BG] Нож за прободен трион "Т" 5 бр. комплект • [RO] Rezerve ferestaru pendular-5buc/set • [SR] List testere za ubodna testera set 5 kom • [MK] Нож за убодна пила сет 5 ком • [RU] Пильное полотно для сабельных пил набор 5 шт [SL] žagin list 5 kos • [EL] Приονόλαμες σέγας Set 5 τεμ • [HR] Listovi pile za drvo 5 kom • [FR] Couteau à découper "T" 5 pcs. kit • [IT] Coltello da taglio "T" 5 pz. set • [ES] Trancilo trancílo "T" 5 PC. kit • [PT] Faca de corte "T" 5 pcs. kit

art. №	tpi	pcs	BARCODE
209911 for wood	8	5	3800123107269
209903for metal	1.6	5	3800123123740

Art. No. 209911



Art. No. 209903



## RECIPROCATING SAW BLADE FOR WOOD AND METAL 2 PCS.

[BG] Нож за саблевиден трион за дърво и метал • [RO] Lama ferestrau sabie ptr lemn HSS • [SR] List testere za sabljasta testera za drvo • [MK] Нож за убодна пила за дрво • [RU] Пильное полотно для маятниковый лобзик • [SL] Žagin list za nihajna vbodna žaga • [EL] Приονόλαμες σέγας приони σεγα • [HR] Listovi pile za drvo za Recipročna pila • [FR] Soucoupe scie à bois • [IT] Seghe piatte per legno • [ES] Saucer vidis por ligno • [PT] Serra de discos para madeira

art. №	length/mm	tpi	pcs	BARCODE
155422	225x0.9(1.8-2.6)	10	2	3800972009738

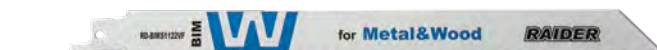

## RECIPROCATING SAW BLADE FOR WOOD 10TPI HSS

[BG] Нож за саблевиден трион за дърво • [RO] Lama ferestrau sabie ptr lemn HSS • [SR] List testere za sabljasta testera za drvo • [MK] Нож за убодна пила за дрво • [RU] Пильное полотно для маятниковый лобзик • [SL] Žagin list za nihajna vbodna žaga • [EL] Приονόλαμες σέγας приони σεγα • [HR] Listovi pile za drvo za Recipročna pila • [FR] Soucoupe scie à bois • [IT] Seghe piatte per legno • [ES] Saucer vidis por ligno • [PT] Serra de discos para madeira

art. №	length/mm	tpi	pcs	BARCODE
155502 RD-WS1531L	240x19x1.5	10	2	3800123164248
155420 RD-WS644D	150x1.25x4.3	2	2	3800972009714
155421 RD-WS1111K	225x1.25x8.5	2	2	3800972009721



## RECIPROCATING SAW BLADE FOR METAL

[BG] Нож за саблевиден трион за метал • [RO] Lama ferestrau sabie ptr metal HSS • [SR] List testere za sabljasta testera za metal • [MK] Нож за убодна пила за метал • [RU] Пильное полотно для маятниковый лобзик • [SL] Žagin list za nihajna vbodna žaga • [EL] Приονόλαμες σέγας приони σεγα • [HR] Listovi pile za metal za Recipročna pila • [FR] Lame de scie alternative pour métal • [IT] Seghetto alternativo per metallo • [ES] Reciprocating Saw Blade for Metal • [PT] Lâmina de Serra Reciprocante para Metal

art. №	length/mm	tpi	pcs	BARCODE
155503	225x19x0.9	24	2	3800123164255



## RECIPROCATING SAW BLADE FOR BRICKS RD-RS2243

[BG] Нож за саблевиден трион за тухли • [RO] Lama ferestrau sabie ptr cărămidă • [SR] List testere za sabljasta testera za oreke • [MK] Нож за уводна пила за тула • [RU] Пильное полотно для маятниковый лобзик • [SL] Žagin list za nihajna vbodna žaga • [EL] Приονόλαμες σεγάς πριονι σεγά • [HR] Listovi pile za cigla za Recipročna pila • [FR] Lame de scie alternative pour briques • [IT] Seghetto alternativo per mattoni • [ES] Reciproca Sudo-klingo por Brikoj • [PT] Lâmina de Serra Reciprocante para Tijolos

art. №	mm	L1/ mm	L2/ mm	pcs	BARCODE
155415	12..7	455	405	1	3800123173813

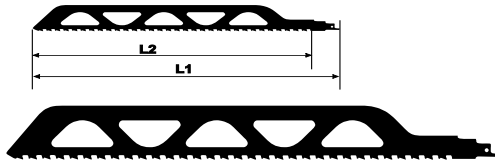

## SAW BLADE FOR OSCILLATING MULTI-TOOL FOR METAL & WOOD

[BG] Нож за Многофункционален Инструмент за метал и дърво • [RO] Rezerve ptr Sculă Multifuncțională [SR] List Testere Za Višenamenski Alat [MK] Нож За Повеќенаменски Алат • [RU] Пильное Полотно Для Многофункциональный Инструмент • [SL] Žagin List za Večnamensko Orodje • [EL] μαχαίρι για Εργαλείο Πολλαπλής Χρής • [HR] Ravna oštrica • [FR] Lame de scie pour outil polyvalent oscillant pour métal et bois • [IT] Saw Blade for Oscillating Multi-Tool per metallo e legno • [ES] Saw Blade por Oscillating Multi-Tool por Metallo & Ligno • [PT] Lâmina de serra para multiferramenta oscilante para metal e madeira

32x40mm

Art. No. 155602  
EAN: 3800123164514

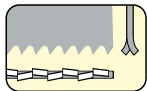

Milled and side set teeth

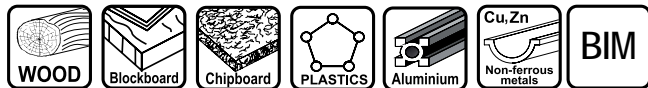

## SAW BLADE FOR OSCILLATING MULTI-TOOL FOR WOOD

[BG] Нож за многофункционален инструмент за дърво • [RO] Rezerve ptr sculă multifuncțională • [SR] List testere za višenamenski alat • [MK] Нож за повеќенаменски алат • [RU] Пильное полотно для многофункциональный инструмент • [SL] Žagin list za večnamensko orodje • [EL] Μαχαίρι για εργαλείο πολλαπλής χρής • [HR] Ravna oštrica • [FR] Lame de scie pour outil polyvalent oscillant pour bois • [IT] Lama per sega per utensile oscillante per legno • [ES] Śirita klingon por oscillating multi-tool por wood • [PT] Lâmina de serra para multiferramenta oscilante para madeira

34x40mm

Art. No. 155601  
EAN: 3800123164507

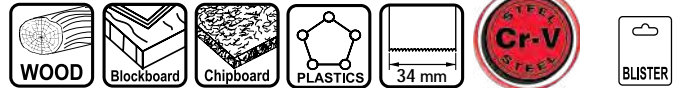

## SAW BLADE FOR OSCILLATING MULTI-TOOL FOR WOOD

Ø87mm

Art. No. 155603  
EAN: 3800123164521

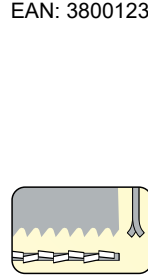

Milled and side set teeth

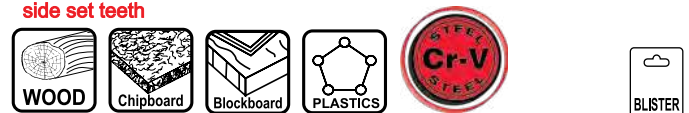

## SAW BLADE FOR OSCILLATING MULTI-TOOL FOR METAL & WOOD

Ø87mm

Art. No. 155604  
EAN: 3800123164538



BIM

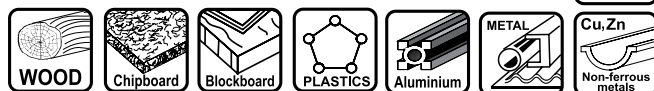

## SCRAPER FOR OSCILLATING MULTI-TOOL

[BG] Шабър за многофункционален инструмент • [RO] Rezerve ptr sculă multifuncțională • [SR] Strugač za višenamenski alat • [MK] Стругало за повеќенаменски алат [RU] Скребок для многофункциональный инструмент [SL] Strgalo za večnamensko orodje • [EL] Ξύστρα για εργαλείο πολλαπλής χρής • [HR] Strugač [FR] Racloir pour outil polyvalent oscillant • [IT] Raschietto per multi attrezzo oscillante • [ES] Skrapilo por oscilla multi-ilo • [PT] Raspador para multiferramenta oscilante

52x45mm

Art. No. 155605  
EAN: 3800123164545



SK7 steel



## SAW BLADE FOR OSCILLATING MULTI-TOOL CARBIDE

[BG] Нож за многофункционален инструмент за фуги Carbide • [RO] Rezerve ptr Sculă Multifuncțională Carbide • [SR] List Testere Za Višenamenski Alat Carbide • [MK] Нож За Повеќенаменски Алат • [RU] Пильное Полотно Для Многофункциональный Инструмент • [SL] Žagin List za Večnamensko Orodje Carbide • [EL] μαχαίρι για Εργαλείο Πολλαπλής Χρής Carbide • [HR] Okrugla oštrica • [FR] Lame de scie pour outil polyvalent oscillant • [IT] Lama per sega per attrezzo oscillante multi-utensile • [ES] Saw Blade por Oscilla Multi-ilo • [PT] Lâmina de serra para multi-ferramenta oscilante

Ø85mm

Art. No. 155606  
EAN: 3800123164552



CARBIDE

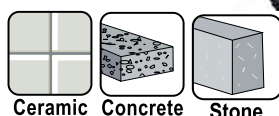

## SANDING PLATE FOR OSCILLATING MULTI-TOOL CARBIDE

[BG] Шлифовъчна плоча за многофункционален инструмент Carbide • [RO] Placă de Șlefuire ptr Sculă Multifuncțională Carbide • [SR] Brusna ploča Za Višenamenski Alat • [MK] Плоча за Брусене За Повеќенаменски Алат • [RU] Шлифпластина Для Многофункциональный Инструмент [SL] Brušenje Ploščo za Večnamensko Orodje Carbide • [EL] Πλάκα λείανσης για εργαλείο Πολλαπλής Χρής Carbide • [HR] Brusni disk • [FR] Plateau abrasif pour carbure multi-outils oscillant • [IT] Piastra di levigatura per carburo multi-utensile oscillante • [ES] Sanding Plate por Oscilla Multi-ilo • [PT] Placa de lixamento para multi-ferramenta oscilante

80mm

Art. No. 155607  
EAN: 3800123164569



CARBIDE

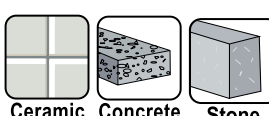



## SANDING PLATE FOR MULTI-TOOL VELCRO

[BG] Шлифовъчна плоча за многофункционален инструмент Velcro • [RO] Placă de Şlefuire ptr Sculă Multifuncţională Velcro [SR] Brusna ploča Za Višenamenski Alat • [MK] Плоча за Брусење За Повеќенаменски Алат • [RU] Шлифпластина Для Многофункциональный Инструмент • [SL] Brušenje Ploščo za Večnamensko Orodje Velcro • [EL] Πλάκα Αερίανσης για Εργαλείο Πολλαπλής Χρής Velcro • [HR] Brusni disk • [FR] Plaque de ponçage pour velcro multi-outils • [IT] Piastra di levigatura per velcro oscillante multi-utensile • [ES] Sanding Plate por Multi-lla Velcro • [PT] Placa de lixamento para o velcro oscilante de várias ferramentas

93mm

Art. No. 155608  
EAN: 3800123164576



## ACCESSORIES FOR OSCILLATING MULTIFUNCTIONAL TOOL 10PCS. KIT

[BG] Аксесоари за многофункционален инструмент 10 бр. комплект • [RO] Set 10 buc banda smirghel Velcro pentru scula multifunctionala • [SR] Prnadležnosti 10 kom za višenamenski alat • [MK] Додатоци 10 ком за повеќенаменски алат • [RU] Аксессуары 10 шт. для многофункциональный инструмент • [SL] Dodatki 10 kos za večnamensko orodje • [EL] Αξεσουάρ Σετ 10 Τεμ για Εργαλείο Πολλαπλής Χρής • [HR] Oscilacijski alat 10 kom • [FR] Accessoires pour outil multifonction oscillant 10 pcs. Trousse • [IT] Accessori per utensile multifunzione oscillante 10 pz. Kit • [ES] Akcesorajoj por Oscillating Multifunction Tool 10 komputiloj. Kit • [PT] Acessórios para ferramenta multifuncional oscilante 10 pcs.

Art. No. 155610  
EAN: 3800123164613

**155609 6pcs; 155608 1pc;**  
**155605 1pc;**  
**155604 1pc, Saw Blade 28 mm**

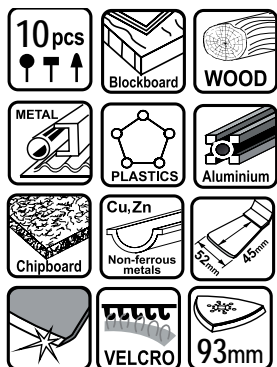

## REVERSIBLE BLADES FOR PLANERS 82MM 2 PCS. SET FOR RD-EPO9, 10 & 11

[BG] Ножове за ренде ел. 2 бр. комплект • [RO] Set 2 buc Lame pentru rindea electrică • [SR] Set Noževa za Električna Hobarica 2 kom. • [MK] Нож за електрично ренде сет 2 бр • [RU] Нож за Электрический станок набор 2 шт • [SL] Electric planer nož kit 2 kosa • [EL] Ηλεκτρικό μηχάνημα μαχαίρι σετ 2 τεμάχια • [HR] Nož blanje 2 kom • [FR] Lames réversibles pour raboteuses 82mm 2 pcs • [IT] Lame reversibili per piallatrici 82mm 2 pz • [ES] Reversibles Klingoj por planantoj 82mm 2 PC • [PT] Láminas reversíveis para plainas 82mm 2 peças

art. №	length/mm	pcs	BARCODE
209937	82	2	3800123104800



## SCROLL SAW BLADE 2 PCS SET

[BG] Нож за машина за орнаменти 2 броя комплект • [RO] set 2 buc lama pentru fierastrau de banc • [SR] List testere za tračna testera 2 kom Set • [MK] Нож за машина за изразување на украси 2 парчиња • [RU] Пильное полотно для выделите пила 2 шт набор • [SL] Žagin list za električna rezbarska žaga • [EL] Πριονόλαμες σέγας για πριονοκορδέλες Σετ 2 τεμ • [HR] Nož za Stroj za rezanje ornamentima 2 kom • [FR] Jeu de 2 lames de scie à chantourner • [IT] Lama per sega a scorimento Set 2 pezzi • [ES] Blade por vidi 2 komputiloj. Kit • [PT] Lámina para serra 2 unidades

art. №	length/mm	pcs	BARCODE
209912	127	2	3800123107627



## SANDING SHEETS FOR OSCILLATING MULTI-TOOL 10 PCS

[BG] Шкурка за многофункционален инструмент 10 бр. комплект Velcro • [RO] 10Psc/Set banda smirghel ptr Sculă Multifuncţională Velcro • [SR] Brusni papir 10 kom za Višenamenski Alat • [MK] Абразивна Хартија 10 ком за Повеќенаменски Алат • [RU] Бумага наждачная 10 шт. Для Многофункциональный Инструмент • [SL] Brusni platna 10 kos za Večnamensko Orodje Velcro • [EL] Γυαλόχαρτο Σετ 10 Τεμ για Εργαλείο Πολλαπλής Χρής Velcro • [HR] Brusni papir 10 kom • [FR] Lame de scie pour outil polyvalent oscillant • [IT] Lama per sega per attrezzo oscillante multi-utensile • [ES] Saw Blade por Oscilla Multi-Ilo • [PT] Lámina de serra para multi-ferramenta oscilante

**GRIT: 60-240**

93mm

Art. No. 155609  
EAN: 3800123164583



## KNIFE FOR PLANNER 2 PCS SET

[BG] Ножове за абрихт 2 броя комплект • [RO] Set 2 cutite pentru rindea electrica • [SR] Nož za rende 2 kom Set • [MK] Ножеви за абрихт 2 парчиња комплект • [RU] Нож строгальный 2 шт набор • [SL] Skobeljni noži 2 kosa • [EL] Μαχαίρια Πλάνη Σετ 2 τεμάχια • [HR] Nož blanje 2 kom • [FR] Couteau pour planificateur 2 pcs Set • [IT] Coltello per Planner Set 2 pezzi • [ES] Knife por Planisto 2 komputiloj • [PT] Faca para Planner 2 pcs Set

art. №	length/mm	pcs	BARCODE
155501	250	2	3800123162060
155504	305	2	3800123171215



## BAND SAW BLADE FOR RD-BSW 18

[BG] Лента за банциг • [RO] Lama ptr ferestrau de banc • [SR] List testere za trakasta testera • [MK] Нож за трачна пила • [RU] Пильное полотно для ленточная пила • [SL] Žagin list za električna rezbarska žaga • [EL] Πριονόλαμες σέγας για πριονοκορδέλες • [HR] Listova pila za Tračna pila • [FR] Lame de scie • [IT] La lama della sega • [ES] Bendita Bando • [PT] Lámina de serra de fita

Art. No. 155701  
EAN: 3800123162183

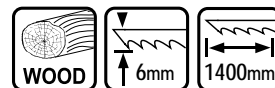

## DIAMOND CUTTING DISC DRY

[BG] Диск диамантен DRY • [RO] Disc diamantat segmentat DRY • [SR] Rezna ploča dijamantska DRY • [MK] Дијамантски диск • [RU] Абразивный круг диаманта DRY • [SL] Diamantna rezalna plošča DRY • [EL] Κύκλοι κοπής διαμαντιών DRY • [HR] Dijamantne ploče DRY • [FR] Disque de coupe le diamant • [IT] Diamond Disco da taglio • [ES] Trancha disco • [PT] Diamond Disco de corte

art. №	model	Ø (mm)	D1 (mm)	BARCODE
162122	-	85	10	3800123166143
162101	DD01	115	22.2 (20)	3800123126123
162104	DD02	125	22.2 (20)	3800123126390
162107	DD03	180	22.2 (25.4)	3800123126406
162110	DD04	230	22.2 (25.4)	3800123126482



## DIAMOND CUTTING DISC TURBO

[BG] Диск диамантен TURBO • [RO] Disc diamantat segmentat TURBO • [SR] Rezna ploča dijamantska TURBO • [MK] Дијамантски диск Т • [RU] Абразивный круг диаманта TURBO • [SL] Diamantna rezalna plošča TURBO • [EL] Κύκλοι κοπής διαμαντιών • [HR] Dijamantne ploče • [FR] Disque de coupe le diamant TURBO • [IT] Diamond Disco da taglio TURBO • [ES] Trancha disco • [PT] Diamond Disco de corte TURBO

art. №	model	Ø (mm)	D1 (mm)	BARCODE
162102	DD05	115	22.2 (20)	3800123126444
162105	DD06	125	22.2 (20)	3800123126451
162108	DD07	180	22.2 (25.4)	3800123126468
162111	DD08	230	22.2 (25.4)	3800123126499



## DIAMOND CUTTING DISC WET

[BG] Диск диамантен WET • [RO] Disc diamantat segmentat WET • [SR] Rezna ploča dijamantska WET • [MK] Дијамантски диск WET • [RU] Абразивный круг диаманта WET • [SL] Diamantna rezalna plošča WET • [EL] Κύκλοι κοπής διαμαντιών WET • [HR] Dijamantne ploče WET • [FR] Disque de coupe le diamant • [IT] Diamond Disco da taglio • [ES] Trancha disco • [PT] Diamond Disco de corte

art. №	model	Ø (mm)	D1 (mm)	BARCODE
162121	CS24	85	10	3800123166136
162123	CS25	110	20	3800123167577
162103	DD09	115	22.2 (20)	3800123126413
162106	DD10	125	22.2 (20)	3800123126420
162109	DD11	180	22.2 (25.4)	3800123126437
162116	DD16	200	22.2 (25.4)	3800123127472
162112	DD12	230	22.2 (25.4)	3800123126611
162117	DD17	300	25.4	3800123127489

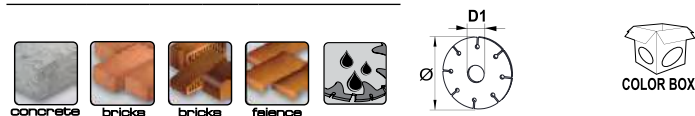

## DIAMOND CUTTING DISC TURBO SUPER THIN

[BG] Диск диамантен TURBO ТЪНЪК • [RO] Disc diamantat segmentat SUBȚIRE • [SR] Rezna ploča dijamantska TURBO TUNUK • [MK] Дијамантски диск • [RU] Абразивный круг диаманта TURBO • [SL] Diamantna rezalna plošča TURBO • [EL] Κύκλοι κοπής διαμαντιών • [HR] Dijamantne ploče • [FR] Disque de coupe le diamant TURBO • [IT] Diamond Disco da taglio TURBO • [ES] Trancha disco • [PT] Diamond Disco de corte TURBO

art. №	model	Ø (mm)	D1 (mm)	BARCODE
162201	DD21	115	22.2 (20)	3800972016415
162202	DD22	125	22.2 (20)	3800972016422

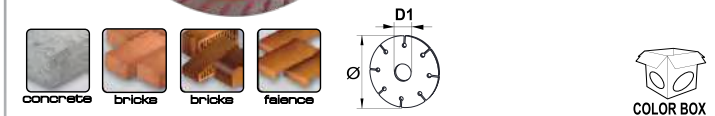

## DIAMOND GRINDING HEAD

[BG] Диск диамантен за шлайфане на бетон • [RO] Disc oala ptr slefuit beton • [SR] Brusna ploča dijamantska • [MK] Дијамантски диск за брусење на бетон • [RU] Абразивный круг диаманта • [SL] Diamantna brusna plošča • [EL] Κύκλος κοπής διαμαντιών τροφίλι για την πέτρα • [HR] Dijamantna brusna ploča • [FR] Tête de broyage le diamant • [IT] Testa di macinazione • [ES] Muelanta kapon • [PT] Diamond Disco cabeça de moagem

art. №	Ø (mm)	D1 (mm)	BARCODE
209931	125	22.2 (20)	3800123150678
209932	180	22.2	3800123150685



## PLASTIC DUST COLLECTOR FOR ANGLE GRINDER

[BG] Предпазител за прахулаване за ъглошлайф • [RO] Colector de praf din plastic pentru polizor unghiular • [SR] Plastični sakupljač prašine za ugaonu brusilicu • [MK] Пластичен колектор за прашина за мелница за агол • [RU] Пластиковый пылесборник для угловых шлифовальных машин • [SL] Plastični zbiralnik prahu za kotno brusilko • [EL] Плаστικός συλλέκτης σκόνης για γωνιακό μύλο • [HR] Plastični sakupljač prašine za kutnu brusilicu • [FR] Dépoussiéreur en plastique pour meuleuse d'angle • [IT] Depolverizzatore in plastica per smerigliatrice angolare • [ES] Plasta polvosucilo por angula muelillo • [PT] Coletor de pó de plástico para rebarbadora

art. №	Ø (mm)	BARCODE
139503	125	3800972015258



## HANDLE FOR ANGLE GRINDER

[BG] Дръжка за ъглошлайф • [RO] Mâner pentru polizor unghiular • [SR] Ručka za ugaonu brusilicu • [MK] Рачка за мелње на агол • [RU] Угловая шлифовальная ручка • [SL] Kotni ročaj brusilnika • [EL] Λαβή για γωνιακό λειαντήρα • [HR] Ručka za kutnu brusilicu • [FR] Poignée auxiliaire pour meuleuse d'angle • [IT] Maniglia per smerigliatrice angolare • [ES] Tenilo por angula muelillo • [PT] Pega para rebarbadora

Ø 115/125mm  
Art. No. 139502  
EAN: 3800972014923





**CUTTING DISC METAL**

[BG] Диск за метал • [RO] Disc pentru taiat metal • [SR] Rezna ploča za metal • [MK] Диск за сечење на метал  
 [RU] Отрезной диск для резки металла • [SL] Rezalne plošče - kovina • [EL] Δίσκος κοπής μετάλλου • [HR] Ploča za rezanje metal  
 [FR] Disque de coupe en métal • [IT] Disco da taglio in metallo • [ES] Trancanta Diskon Metalo • [PT] Metal de disco de corte

art. №	Ø (mm)	D1 (mm)	D2 (mm)	BARCODE
160150	85	10	1.0	3800123166129
160118	115	22.2	1.0	3800123119538
160115	115	22.2	1.2	3800123113000
160106	115	22.2	1.6	3800123126314
160101	115	22.2	3.2	3800123126031
160119	125	22.2	1.0	3800123119545
160116	125	22.2	1.2	3800123113604
160117	125	22.2	1.6	3800123113611
160102	125	22.2	3.2	3800123126550
160113	150	22.2	3.2	3800123127274
160107	180	22.2	2.0	3800123126321
160103	180	22.2	3.2	3800123126048
160108	230	22.2	2.0	3800123126338
160104	230	22.2	3.2	3800123126086
160105	355	25.4	3.2	3800123126284

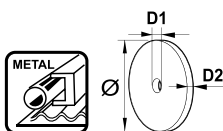

**GRINDING DISC METAL**

[BG] Диск за шлайфане • [RO] Disc abraziv • [SR] Brusna ploča za metal • [MK] Диск за брусење на метал  
 [RU] Диск шлифовальный по металлу • [SL] Plošče za brušenje - kovina • [EL] Δίσκος λείονσης των μετάλλων  
 • [HR] Brusna ploča • [FR] Disque de meulage en métal • [IT] Disco abrasivo • [ES] Muelanta Diskon • [PT] Disco de moagem

art. №	Ø (mm)	D1 (mm)	D2 (mm)	BARCODE
160109	115	22.2	6	3800123126604
160110	125	22.2	6	3800123126567
160111	180	22.2	6	3800123126574
160112	230	22.2	6	3800123126581

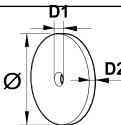

**CUTTING DISC METAL A60T INOX**

[BG] Диск за метал A60T Inox • [RO] Disc pentru taiat metal A60T Inox • [SR] Rezna ploča za metal A60T Inox • [MK] Диск за сечење на метал  
 [RU] Отрезной диск для резки металла A60T Inox • [SL] Rezalne plošče - kovina • [EL] Δίσκος κοπής μετάλλου • [HR] Ploča za rezanje metal A60T Inox • [FR] Disque de meulage en métal • [IT] Disco abrasivo • [ES] Muelanta Diskon • [PT] Disco de moagem

art. №	Ø (mm)	D1 (mm)	D2 (mm)	BARCODE
160120	115	22.2	1.0	3800123166471
160121	125	22.2	1.0	3800123166488

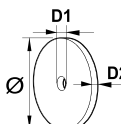

**CUTTING DISC STONE**

[BG] Диск за неметал • [RO] Disc taieri usoare-non metal • [SR] Rezna ploča • [MK] Диск за сечење  
 [RU] Отрезной диск для резки металла • [SL] Rezalne plošče - kovina • [EL] Δίσκος κοπής • [HR] Ploča za rezanje cigli  
 [FR] Disque de coupe en pierre • [IT] Disco da taglio • [ES] Trancanta Disko Štono • [PT] Pedra de disco de corte

art. №	Ø (mm)	D1 (mm)	D2 (mm)	BARCODE
161101	115	22.2	3.2	3800123126307
161102	180	22.2	3.2	3800123126093
161103	230	22.2	3.2	3800123126109

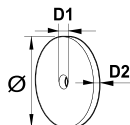

**CUTTING DISC METAL**

[BG] Диск за метал • [RO] Disc pentru taiat metal • [SR] Rezna ploča za metal • [MK] Диск за сечење на метал  
 [RU] Отрезной диск для резки металла • [SL] Rezalne plošče - kovina • [EL] Δίσκος κοπής μετάλλου • [HR] Ploča za rezanje metal  
 [FR] Disque de coupe en métal • [IT] Disco da taglio in metallo • [ES] Trancanta Diskon Metalo • [PT] Metal de disco de corte

art. №	Ø (mm)	D1 (mm)	D2 (mm)	BARCODE
160152	125	22.2	1.0	3800972014633



10pcs

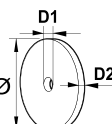

**CUTTING DISC METAL**

[BG] Диск за метал • [RO] Disc pentru taiat metal • [SR] Rezna ploča za metal • [MK] Диск за сечење на метал  
 [RU] Отрезной диск для резки металла • [SL] Rezalne plošče - kovina • [EL] Δίσκος κοπής μετάλλου • [HR] Ploča za rezanje metal  
 [FR] Scie circulaire • [IT] Disco da taglio • [ES] Trancanta Disko • [PT] Disco de corte

art. №	Ø (mm)	D1 (mm)	D2 (mm)	BARCODE
160122	115	22.2	2.5	3800123166495
160123	115	22.2	3.0	3800123166501
160124	125	22.2	2.5	3800123166518
160125	125	22.2	3.0	3800123166525
160126	180	22.2	3.0	3800123166532
160127	230	22.2	2.0	3800123166549
160128	230	22.2	3.0	3800123166556
160129	350	25.4	3.5	3800123166563

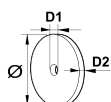

**GRINDING DISC METAL**

[BG] Диск за неметал • [RO] Disc taieri usoare-non metal • [SR] Rezna ploča • [MK] Диск за сечење  
 [RU] Отрезной диск • [SL] Rezalne plošče - kovina • [EL] Δίσκος κοπής • [HR] Ploča za rezanje cigli  
 [FR] Disque de coupe en pierre • [IT] Disco da taglio • [ES] Trancanta Disko Štono • [PT] Pedra de disco de corte

art. №	Ø (mm)	D1 (mm)	D2 (mm)	BARCODE
160134	115	22.2	3.0	3800123166617
160135	125	22.2	3.0	3800123166624
160136	180	22.2	3.0	3800123166631
160137	230	22.2	3.0	3800123166648

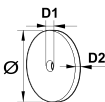

## GRINDING DISC METAL

[BG] Диск за шлайфване • [RO] Disc abraziv • [SR] Brusna ploča za metal • [MK] Диск за брусење на метал • [RU] Диск шлифовальный по металлу • [SL] Plošče za brušenje - kovina • [EL] Δίσκος λείανσης των μετάλλων • [HR] Brusna ploča • [FR] Disque de meulage en métal • [IT] Disco abrasivo • [ES] Muelanta Diskon • [PT] Disco de moagem

art. №	Ø (mm)	D1 (mm)	D2 (mm)	BARCODE
160144	115	22.2	6.0	3800123166570
160145	125	22.2	6.0	3800123166587
160146	180	22.2	6.0	3800123166594
160147	230	22.2	6.0	3800123166600

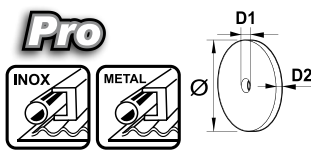

## DISC FOR ANGLE GRINDER CARBIDE MULTI WHEEL

[BG] Диск за ъглошлайф Carbide Multi Wheel • [RO] Disc pentru polizor unghiular Carbide Multi Wheel • [SR] Disk za kutnu brusilicu Carbide Multi Wheel • [MK] Диск за мелeње на агол Карбид Мулти тркало • [RU] Диск для угловой шлифовальной машины Carbide Multi Wheel • [SL] Disk za kotni brusilnik Carbide Multi Wheel • [EL] Κύκλοι κοπής διαμαντιών DRY • [HR] Dijamantne ploče DRY • [FR] Disque de coupe le diamant • [IT] Diamond Disco da taglio • [ES] Tranča disko • [PT] Diamond Disco de corte

art. №	Ø (mm)	D1 (mm)	BARCODE
160153	115	22.2 (20)	3800972015234
160154	125	22.2 (20)	3800972015241



## DISC FOR BISCUIT JOINER

[BG] Диск за фреза за плоски дибли (Бисквит Машина) • [RO] Disc pentru masina de frezat - dibluri plate • [SR] Rezna ploča za glodalica za žljebove • [MK] Диск за гладалка за жлеbove • [RU] Отрезной диск для фрезы для плоских шкантов • [SL] Rezne plošče za lamelni rezalniki • [EL] Δίσκος κοπής φρεζ(οκαβιλιέρα) • [HR] Ploča za rezanje za Glodalica Za Utore • [FR] Disque de coupe pour le moulin pour goujons plats • [IT] Disco da taglio per il mulino per tasselli piatti • [ES] Tranča disko por la Muelejo por Platformaj Dokaloj • [PT] Disco de corte para o moinho para buchas planas

art. №	Ø (mm)	D1 (mm)	Thickness/mm	teeth	BARCODE
163141	100	22.2 (20)	4	6	3800123167553

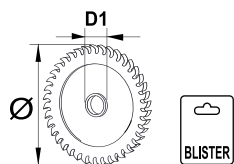

## CIRCULAR SAW BLADE METAL AND WOOD FOR RD-CS25

[BG] Диск за циркуляр за метал и дърво • [RO] Disc circular metal și lemn • [SR] List testere metal i drvo • [MK] Кружна Пила за метал и дрво • [RU] Циркулярный диск для металл и дерево • [SL] List za krožno žago kovine in lesa • [EL] Διακοπριονα μέταλλο και ξύλο • [HR] Listova pila za metal i drvo • [FR] Lame de scie circulaire métal et bois • [IT] Lama per seghe circolari in metallo e legno • [ES] Circular Saw Blade Metalu kaj Ligno • [PT] Lâmina de serra circular de metal e madeira

art. №	Ø (mm)	D1 (mm)	teeth	BARCODE
163139	110	20	24	3800123167560

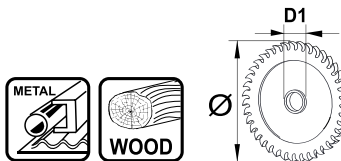

## CIRCULAR SAW BLADE

[BG] Диск за циркуляр • [RO] Disc circular • [SR] List testere • [MK] Кружна Пила за Дрво • [RU] Циркулярный диск • [SL] List za krožno žago • [EL] Διακοπριονα • [HR] Listova pila • [FR] Lame de scie circulaire • [IT] Lama per seghe circolari • [ES] Vidita klingo • [PT] Lâmina de serra circular

art. №	Ø (mm)	D1 (mm)	D1 (ring)	teeth (pcs)	BARCODE
163137	85	10	-	30	3800123166105
163138	85	10	-	80	3800123166112
163113	115	22.2	16 20	24	3800123126079
163134	115	22.2	16 20	36	3800123158247
163131	125	22.2	16 20	40	3800123141843
163106	160	20	16	24	3800123126628
163102	180	20	16	24	3800123126116
163128	185	20	16	24	3800123139420
163132	185	20	16	60	3800123141850
163135	190	20	16	24	3800123158810
163129	190	25.4	16 20	40	3800123139437
163136	190	20	16	80	3800123158827
163130	200	16	-	24	3800123139444
163104	210	25.4	16 20	24	3800123126635
163133	210	30	20 25.4	24	3800123143694
163115	210	30	20 25.4	60	3800123160004
163103	230	22.2	16 20	40	3800123126383
163116	250	30	20 25.4	48	3800123160707
163117	250	30	20 25.4	60	3800123160714
163114	254	25.4	16 20	60	3800123127953
163107	300	25.4	16 20	56	3800123126659

art. №	Ø (mm)	D1 (mm)	D1 (ring)	teeth (pcs)	BARCODE
163110	300	30	20 25.4	56	3800123126949
163144	305	30	-	100	3800972010772
163126	315	30	20 25.4	40	3800123127496
163108	350	25.4	16 20	56	3800123126666
163111	350	30	20 25.4	56	3800123126956
163109	400	25.4	16 20	56	3800123126673
163112	400	30	20 25.4	56	3800123126963
163145	190	30	-	24	3800972019584
163146	190	30	-	36	3800972019591
163147	190	30	-	48	3800972019607
163148	190	30	-	60	3800972019614
163149	200	30	-	24	3800972019621
163150	210	30	-	48	3800972019638
163151	254	30	-	40	3800972019645
163152	254	30	-	80	3800972019652

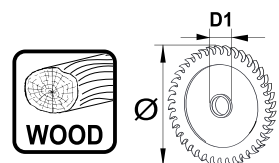

## FOR ALUMINUM / ЗА РЪЗАНЕ НА АЛУМИНИЙ

art. №	Ø (mm)	D1 (mm)	D1 (ring)	teeth (pcs)	BARCODE
163118	255	25.4	16 20	100	3800123160721





## FLAP DISC

[BG] Диск ламелен • [RO] Disc ptr slefuit • [SR] Brusni papir lamelni • [MK] Ламинарен абразивен диск • [RU] Плита диска • [SL] Lamelna brusilna plošča • [EL] Δίσκοι με πτερύγια από χαρτί λαϊανός • [HR] Lamelirane brusne ploče • [FR] Plaques de meulage lamellaires • [IT] Piastre di macinazione lamellare • [ES] Lamellar muelanta telerojn • [PT] Placas de moagem lamelar

art. №	Ø <sub>1</sub> (mm)	Ø <sub>2</sub> (mm)	A	BARCODE
164112	115	22	A-40	3800123127298
164102	115	22	A-60	3800123126352
164103	115	22	A-80	3800123126369
164104	115	22	A-100	3800123126376
164105	115	22	A-120	3800123126543
164113	115	22	A-150	3800123150746
164118	125	22	A-40	3800123151095
164119	125	22	A-60	3800123151101
164120	125	22	A-80	3800123151118
164121	125	22	A-100	3800123151125
164122	125	22	A-120	3800123151132
164123	125	22	A-150	3800123151149

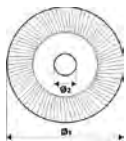

EN 13743



## FLAP WHEEL BURNISHING MOP FOR POWER DRILL

[BG] Диск за сваляне на ръжда за бормашина • [RO] Perie segmentata smirghel-cu tija • [SR] Brusna lepeza [MK] Абразивен диск за бормашина • [RU] Дрель и лепестковая шлифовальная насадка • [SL] Lamelasti kolut na osovini • [EL] Πολύπτερο γυαλόχαρτο • [HR] Lepezasti brusni kolut • [FR] Disque pour enlever la rouille • [IT] Disco per rimuovere la ruggine • [ES] Disko por forigi ruston • [PT] Disco para remoção de ferrugem

Ø64mm

Art. No. 209920

EAN: 3800123127625



## WIRE CUP BRUSH BRASSED WITH SHANK

[BG] Четка за бормашина камбана месинг • [RO] Perie sarma rotativa • [SR] Četka čelična kružna mesing • [MK] Жичана Челична Четка • [RU] Щетка чашки волнистой • [SL] Žična ščetka • [EL] Συρμάτινη βούρτσα τροχού • [HR] Lončasta žičana četka za bušilice - valovita žica • [FR] Brosse de perceuse en laiton • [IT] Spazzola per trapano in ottone • [ES] Drilo Broso • [PT] Escova de broca de latão

art. №	Ø (mm)	BARCODE
170101	50 (2")	3800123102042
170102	75 (3")	3800123102059
170103	100 (4")	3800123102066



## TWIST KNOT WIRE CUP BRUSH WITH SHANK FOR RDP-CDL01

[BG] Четка за бормашина камбана плетена • [RO] Perie sarma rotativa pentru masina de gaurit • [SR] Četka čelična kružna za bušilica • [MK] Жичана челична четка за бормашина • [RU] Щетка чашки волнистой за дрель [SL] Žična ščetka za udarni vrtalnik • [EL] Συρμάτινη βούρτσα τροχού για κρουστικό δρπαπνο • [HR] Ravna žičana četka • [FR] Brosse de forage • [IT] Pennello da trapano • [ES] Cepillo de taladro • [PT] Escova de perfuração

Ø25mm (1")

Art. No. 170107

EAN: 3800123163661



## TWIST KNOT WIRE CUP BRUSH WITH SHANK

[BG] Четка за бормашина камбана плетена • [RO] Perie sarma rotativa pentru masina de gaurit • [SR] Četka čelična kružna za bušilica • [MK] Жичана челична четка за бормашина • [RU] Щетка чашки волнистой за дрель [SL] Žična ščetka za udarni vrtalnik • [EL] Συρμάτινη βούρτσα τροχού για κρουστικό δρπαпно • [HR] Ravna žičana četka • [FR] Brosse de forage • [IT] Pennello da trapano • [ES] Cepillo de taladro • [PT] Escova de perfuração

Ø75mm (3")

Art. No. 170109

EAN: 3800123163685



## WIRE WHEEL BRUSH BRASSED WITH SHANK

[BG] Четка за бормашина плоска месинг • [RO] Perie sarma cu tija ptr bormasina • [SR] Četka čelična ravna mesing • [MK] Жичана Челична Четка • [RU] Стальная латунированная волнистая проволока • [SL] Žična ščetka • [EL] Συρμάτινη βούρτσα τροχού • [HR] Plosnata žičana četka - valovita žica • [FR] Brosse de forage • [IT] Pennello da trapano • [ES] Cepillo de taladro • [PT] Escova de perfuração

art. №	Ø (mm)	BARCODE
170104	50 (2")	3800123102073
170105	75 (3")	3800123102080
170106	100 (4")	3800123102097



## TWIST KNOT WIRE WHEEL BRUSH WITH SHANK

[BG] Четка за бормашина плоска плетена • [RO] Perie circulara rotativa • [SR] Četka čelična ravna upletena • [MK] Жичана Челична Четка (Увртена) • [RU] Стальная переплетенная щетка • [SL] Lončasta ščetka - pletena žica • [EL] Ποτηροειδής βούρτσα – πλεγμένο σύρμα • [HR] Plosnata žičana četka - pletena • [FR] Brosse de forage • [IT] Pennello da trapano • [ES] Cepillo de taladro • [PT] Escova de perfuração

Ø75mm (3")

Art. No. 170108

EAN: 3800123163678



## WIRE CUP BRUSH BRASSED FOR ANGLE GRINDER

[BG] Четка за ъглошлиф камбана месинг • [RO] Set 20 buc perii sarma pentru bormasina • [SR] Četka čelična kružna mesing • [MK] Жичана Челична Четка [RU] Щетка чашки волнистой [SL] Žična ščetka • [EL] Συρμάτινη βούρτσα τροχού • [HR] Lončasta žičana četka - valovita žica • [FR] Brosse d'angle • [IT] Spazzola smerigliatrice angolare • [ES] Cepillo de amoladora angular • [PT] Escova de rebarbadora

art. №	Ø (mm)	BARCODE
171103	75	3800123102103
171106	100	3800123102110
171121	125	3800123151248



COLOR BOX

## TWIST KNOT WIRE CUP BRUSH FOR ANGLE GRINDER

[BG] Четка за ъглошлиф камбана плетена • [RO] Set 3 buc perii sarma pentru bormasina • [SR] Četka čelična kružna upletena • [MK] Жичана Челична Четка (Увртена) • [RU] Стальная переплетенная щетка • [SL] Lončasta ščetka - pletena žica • [EL] Ποτρωειδής βούρτσα - πλεγμένο σύρμα • [HR] Lončasta žičana četka - pletena čelična žica • [FR] Brosse d'angle • [IT] Spazzola smerigliatrice angolare • [ES] Cepillo de amoladora angular • [PT] Escova de rebarbadora

art. №	Ø (mm)	BARCODE
171101	75	3800123102127
171104	100	3800123102134
171107	125	3800123102141



COLOR BOX

## TWIST KNOT WIRE CUP BRUSH HEAVY DUTY FOR ANGLE GRINDER

[BG] Четка за ъглошлиф камбана плетена усилена • [RO] Perie sarma rotativa • [SR] Četka čelična kružna upletena • [MK] Жичана Челична Четка (Увртена) • [RU] Стальная переплетенная щетка • [SL] Lončasta ščetka - pletena žica • [EL] Ποτρωειδής βούρτσα - πλεγμένο σύρμα • [HR] Lončasta žičana četka - pletena čelična žica • [FR] Brosse d'angle • [IT] Spazzola smerigliatrice angolare • [ES] Cepillo de amoladora angular • [PT] Escova de rebarbadora

art. №	Ø (mm)	BARCODE
171102	75	3800123102158
171105	100	3800123102165



COLOR BOX

## TWIST KNOT WIRE SAUCER CUP BRUSH FOR ANGLE GRINDER

[BG] Четка за ъглошлиф конусна плетена • [RO] Perie sarma rotativa • [SR] Četka čelična kružna upletena • [MK] Жичана Челична Четка (Увртена) • [RU] Стальная переплетенная щетка • [SL] Lončasta ščetka - pletena žica • [EL] Ποτρωειδής βούρτσα - πλεγμένο σύρμα • [HR] Plosnata žičana četka • [FR] Brosse d'angle • [IT] Spazzola smerigliatrice angolare • [ES] Cepillo de amoladora angular • [PT] Escova de rebarbadora

Ø 100mm

Art. No. 171122  
EAN: 3800123163630



BLISTER

## TWIST KNOT WIRE WHEEL BRUSH FOR ANGLE GRINDER

[BG] Четка за ъглошлиф плоска плетена • [RO] Perie circulara rotativa • [SR] Četka čelična ravna upletena • [MK] Жичана Челична Четка (Увртена) • [RU] Стальная переплетенная щетка • [SL] Lončasta ščetka - pletena žica • [EL] Ποτρωειδής βούρτσα - πλεγμένο σύρμα • [HR] Plosnata žičana četka - pletena • [FR] Brosse d'angle • [IT] Spazzola smerigliatrice angolare • [ES] Cepillo de amoladora angular • [PT] Escova de rebarbadora

art. №	Ø (mm)	BARCODE
171108	100	3800123102172
171109	150	3800123102189
171110	200	3800123102288



COLOR BOX

## WIRE BRUSHES BRASSED WITH SHANK 3 PCS SET

[BG] Четки за бормашина месинг 3 бр. комплект • [RO] 3 Pcs/Set perii sarma ptr bormasina • [SR] Četka čelična set 3 kom • [MK] Жичана Челична Четка сет 3 ком месинг • [RU] Щетка волнистой проволоки круговая набор 3 шт. • [SL] Žične ščetke 3 kos • [EL] Ποτρωειδής βούρτσα Σет 3 τεμάχια • [HR] Čelične žičane četke 3 kom. • [FR] Brosses pour perceuse en laiton 3 pcs. kit • [IT] Spazzole per trapano in ottone 3 pz. set • [ES] Cepillos para taladro de latón 3 uds. kit • [PT] Escovas para broca de latão 3 peças. kit

3pcs  
Art. No. 177101  
EAN: 3800123102240



BLISTER

## WIRE WHEEL BRUSH BRASSED FOR BENCH GRINDER

[BG] Четка за шмиргел месинг • [RO] Perie circulara din sarma • [SR] Četka čelična za oštrač mesing • [MK] Жичана Челична Четка за струг месинг • [RU] Щетка волнистой проволоки круговая • [SL] Žične ščetke za dvojno brusilno napravo • [EL] Ποτρωειδής βούρτσα • [HR] Plosnata žičana četka - valovita žica • [FR] Brosse en laiton • [IT] Pennello in ottone • [ES] Cepillo de latón • [PT] Escova para lixadeira

art. №	Ø (mm)	BARCODE
172101	125 (5")	3800123102196
172102	150 (6")	3800123102202
172103	200 (8")	3800123102219



COLOR BOX

## WIRE BRUSHES BRASSED WITH SHANK 20 PCS SET

[BG] Четки за бормашина месинг 20 бр. комплект • [RO] 20 Pcs/Set perii sarma ptr bormasina • [SR] Četka čelična set 20 kom • [MK] Жичана Челична Четка сет 20 ком месинг • [RU] Щетка волнистой проволоки круговая набор 20 шт. • [SL] Žične ščetke 20 kos • [EL] Ποτρωειδής βούρτσα Σет 20 τεμάχια • [HR] Čelične žičane četke 20 kom. • [FR] Brosses pour perceuse en laiton 20 pcs. kit • [IT] Spazzole per trapano in ottone 20 pz. set • [ES] Cepillos para taladro de latón 20 uds. kit • [PT] Escovas para broca de latão 20 peças. kit

20pcs  
Art. No. 177103  
EAN: 3800123102264



COLOR BOX



## SANDING SHEETS FOR SANDER WITH 8 HOLES 10PCS

[BG] Шкурка за виброшлайф с 8 отвора 10бр • [RO] Set 10 buc banda smirghel perforate • [SR] Brusni papir 10 kom • [MK] Абразивна Хартија 10 ком • [RU] Бумага наждачная 10 шт. • [SL] Brusni platna 10 kos • [EL] Γυαλόχαρτο Σετ 10 τεμάχια • [HR] Brusni papir 10 kom. • [FR] Ponceuse pour broyeur vibrant 10 pcs. • [IT] Levigatrice per smerigliatrice vibrante 10 pz. • [ES] Lijadora para amoladora vibratoria 10 uds. • [PT] Lixadeira para moedor vibratório 10 pcs.

art. №	L1 (mm)	L2 (mm)	P	BARCODE
180101	93	230	P60	3800123135446
180112	93	230	P80	3800123150555
180102	93	230	P100	3800123135453
180103	93	230	P120	3800123135460
180113	93	230	P150	3800123150562
180104	93	230	P180	3800123135477
180105	93	230	P240	3800123135484
180114	115	280	P40	3800123150579
180106	115	280	P60	3800123135491
180115	115	280	P80	3800123150586
180107	115	280	P100	3800123135507
180108	115	280	P120	3800123135514
180116	115	280	P150	3800123150593
180109	115	280	P180	3800123135521
180110	115	280	P220	3800123135538



10pcs / 8holes

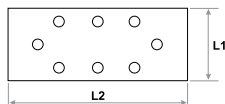

## SANDING BELTS FOR BENCH GRINDER WITH SANDING BELT 5 PCS

[BG] Шкурка за лентов шмиргел 5 бр • [RO] Set 5 buc banda smirghel • [SR] Brusna traka Set 5 kom • [MK] Абразивна Трака 5 ком [RU] Лента для шлифмашины 5 шт. • [SL] Brusni trakovi kovina 5 kos • [EL] Ιμαντες λειανσης 5 τεμάχια • [HR] Brusna traka za Stolna brusilica 5 kom • [FR] Papier abrasif pour bande abrasive 5pcs. • [IT] Carta abrasiva per levigatura della cinghia 5 pezzi. • [ES] Papel de lija para lijat cinta 5 pcs. • [PT] Lixa para cinto de lixar 5pcs.

5pcs / 50x686mm

art. №	P	BARCODE
183116	P40	3800123135309
183117	P60	3800123135316
183118	P80	3800123135323
183119	P100	3800123135330
183120	P120	3800123136252



## SANDING BELTS FOR BELT SANDER 5 PCS

[BG] Шкурка за лентов шлайф 5 броя • [RO] Set 5 buc banda smirghel • [SR] Brusna traka Set 5 kom [MK] Абразивна Трака 5 ком • [RU] Лента для шлифмашины 5 шт. • [SL] Brusni trakovi kovina 5 kos [EL] Ιμαντες λειανσης 5 τεμάχια • [HR] Brusna traka za Tračne brusilice 5 kom • [FR] Papier abrasif pour 5 meuleuses à bande • [IT] Carta abrasiva per 5 smerigliatrici a nastro • [ES] Papel de lija para 5 amoladoras de cinta • [PT] Lixa para 5 moedores de correia

art. №	mm	P	BARCODE
183111	75x457	P40	3800123135170
183112	75x457	P60	3800123135187
183113	75x457	P80	3800123135194
183114	75x457	P100	3800123135200
183115	75x457	P120	3800123135224
183106	75x533	P40	3800123135996
183107	75x533	P60	3800123136009
183108	75x533	P80	3800123136207
183109	75x533	P100	3800123135156
183110	75x533	P120	3800123135163



5pcs



## PAPER SANDING DISCS VELCRO 10PCS

[BG] Шкурка VELCRO 10 бр. • [RO] Set 10 buc banda smirghel circulara Velcro • [SR] Brusni papir VELCRO 10 kom • [MK] Абразивна Хартија VELCRO 10 ком • [RU] Бумага наждачная 10 шт. • [SL] Brusni platna 10 kos • [EL] Γυαλόχαρτο Σετ 10 τεμάχια • [HR] Brusni papir VELCRO 10 kom • [FR] Disques à poncer VELCRO 10pcs • [IT] Dischi abrasivi per carta VELCRO 10 pezzi • [ES] Discos de lija de papel VELCRO 10 piezas • [PT] Discos de lixamento de papel VELCRO 10pcs

art. №	∅ (mm)		BARCODE
180702	115	K40	3800123134906
180703	115	K60	3800123134913
180704	115	K80	3800123134920
180705	115	K100	3800123134937
180706	115	K120	3800123134944

10pcs / ∅115mm

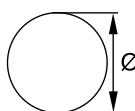

## SANDING DISCS FOR RANDOM ORBIT SANDER WITH 8 HOLES 10PCS

[BG] Шкурка за ексцентършлайф с 8 отвора 10 бр • [RO] Set 10 buc banda smirghel stefuitior circular • [SR] Brusni papir 10 kom • [MK] Абразивна Хартија 10 ком • [RU] Бумага наждачная 10 шт. • [SL] Brusni platna 10 kos • [EL] Γυαλόχαρτο Σετ 10 τεμάχια • [HR] Brusni papir za Ekscentrične brusilice 10 kom • [FR] Disques de ponçage pour ponceuse à orbite aléatoire avec 8 trous 10pcs • [IT] Dischi abrasivi per levigatrice orbitale casuale con 8 fori 10 pezzi • [ES] Discos de lijat para lijadora de órbita aleatoria con 8 orificios 10pcs • [PT] Discos de lixamento para lixadeira de órbita aleatória com 8 furos 10pcs

art. №	∅ (mm)		BARCODE
181101	125	K60	3800123135545
181102	125	K120	3800123135552
181103	125	K180	3800123135569
181104	125	K240	3800123135576

10pcs / 8holes

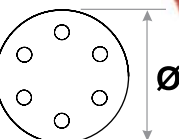

## PAPER SANDING DISCS VELCRO WITH 6 HOLES 10PCS

[BG] Шкурка VELCRO с 6 отвора 10 бр. • [RO] Set 10 buc banda circulara smirghel • [SR] Brusni papir VELCRO 10 kom • [MK] Абразивна Хартија VELCRO 10 ком • [RU] Бумага наждачная 10 шт. • [SL] Brusni platna 10 kos • [EL] γυαλόχαρτο Σετ 10 τεμάχια • [HR] Brusni papir VELCRO 10 kom • [FR] Disques à poncer VELCRO 10pcs • [IT] Dischi abrasivi per carta VELCRO 10 pezzi • [ES] Discos de lija de papel VELCRO 10 piezas • [PT] Discos de lixamento de papel VELCRO 10pcs

art. №	∅ (mm)		BARCODE
180713	150	K60	3800123165412
180714	150	K80	3800123165429
180715	150	K100	3800123165436
180716	150	K120	3800123165443
180717	150	K150	3800123165450
180718	150	K180	3800123165467
180719	150	K220	3800123165474
180720	150	K240	3800123165481

10pcs / 6holes

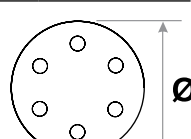

## PAPER SANDING SHEET VELCRO

[BG] Шкурка VELCRO • [RO] Benzi circulare smirghel VELCRO • [SR] Brusni papir VELCRO • [MK] Абразивна Хартија VELCRO • [RU] Бумага наждачная • [SL] Brusni platna VELCRO • [EL] Γυαλόχαρτο VELCRO • [HR] Brusni papir VELCRO • [FR] Disques à poncer VELCRO 10pcs • [IT] Dischi abrasivi per carta VELCRO • [ES] Discos de lija de papel VELCRO • [PT] Discos de lixamento de papel VELCRO

## PAPER SANDING DISC VELCRO FOR LONG-NECK SANDERS VELCRO

art. №	Ø (mm)	grit	BARCODE
180721	225	80	3800123166266
180724	225	100	3800123166723
180722	225	120	3800123166273
180723	225	150	3800123166280
180725	225	180	3800972002180

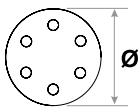

## TRIANGULAR SANDING SHEETS

art. №	Ø (mm)	grit	BARCODE
180726	285	80	3800972003378
180727	285	100	3800972003385
180728	285	120	3800972003392
180729	285	150	3800972003408
180730	285	180	3800972003415

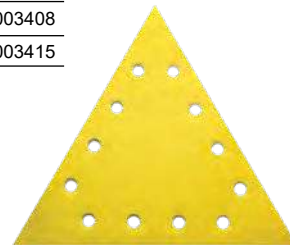
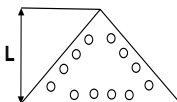

## ABRASIVE FLAP WHEEL FOR POWER DRILL

[BG] Шкурка за бормашина ламелна • [RO] Perie segmentata smirghel • [SR] Brusni papir lerezasti • [MK] Ламинарен абразивен диск за бормашина • [RU] Диск лепестковый для дрели • [SL] Pahljačasti brusilnik • [EL] Γυαλόχαρτα κυλινδρική με άξονα • [HR] Lerezasti brusni čerovi • [FR] Roue à lamelles abrasive pour perceuse • [IT] Ruota lamellare abrasiva per trapano elettrico • [ES] Abrasive flap rado por potencia drilo [PT] Roda de aba abrasiva para furadeira

art. №	Ø (mm)	BARCODE
183501	50	K60 3800123135712
183502	50	K120 3800123135729
183503	60	K60 3800123135736
183504	60	K120 3800123135743
183505	80	K60 3800123135750
183506	80	K120 3800123135767



## DRYWALL PLASTER SANDING SCREEN 5 PCS

[BG] Шкурка мрежа от силициев карбид 5 бр. • [RO] Set 5 buc rezerva bagheta silicon • [SR] Brusni papir 5 kom • [MK] Абразивна Хартија 5 ком • [RU] Латекса абразивной бумага карбида 5 шт. • [SL] Brusni platna 5 kos • [EL] Σιλικεροχαρτο Σετ 5 τεμ • [HR] Brusna mreža silicij karbid • [FR] Écran de ponçage de plâtre pour cloisons sèches 5 PC • [IT] Rete di carta vetrata 5 pezzi • [ES] Reto de rekta flugo 5pcs • [PT] Rede de lixa 5 pcs

art. №	L1 (mm)	L2 (mm)	BARCODE
184101	93	230	P40 3800123150609
184102	93	230	P60 3800123150616
184103	93	230	P80 3800123150623
184104	93	230	P100 3800123150630
184105	93	230	P120 3800123150647
184106	93	230	P150 3800123150654

5pcs/ 93x230mm

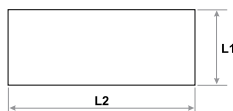

## SANDING SPONGE

[BG] Гъба абразивна • [RO] Burete smirghel • [SR] Sunder za brušenje • [MK] Абразивен сунѓер • [RU] Абразивная губка • [SL] Gobice za ročno brušenje • [EL] Λειαντικά Σφουγγάρια • [HR] Brusna spužva • [FR] Éponge de ponçage • [IT] Spugna abrasiva • [ES] Sanding-Spongo • [PT] Esponja de lixamento

art. №	L1 (mm)	L2 (mm)	H (mm)	P	BARCODE
189101	70	100	25	P40	3800123136269
189102	70	100	25	P60	3800123136276
189103	70	100	25	P80	3800123136283
189104	70	100	25	P100	3800123136290
189105	70	100	25	P120	3800123136306
189106	70	100	25	P150	3800123136313

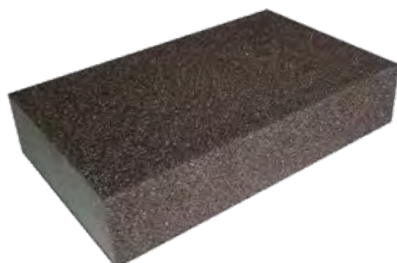
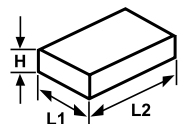

**RAIDER**  
Accessories



**SCREWDRIVER BITS 1/4" 29 PCS SET**

[BG] Накрайници 29 броя комплект • [RO] Set biti 29 buc • [SR] Pin Set 29 kom • [MK] Битови, Сет 29 Пар • [RU] Набор бит 29 пр • [SL] Set bit-nastavkov 29-delni komplet • [EL] Σет μύτες 29 τεμαχίων σε κασετίνα • [HR] Set bitovi 29 kom • [FR] Embouts de tournevis 1/4 "29 pièces • [IT] Set di cacciaviti 1/4 "Set 29 pezzi • [ES] Destornillataj Bitoj 1/4 "29 Pcs-Aro • [PT] Chave de fenda 1/4 "29 Pcs Set

pcs	Name	Sizing
24	25mm(L) BIT	<ul style="list-style-type: none"> <li>5PC SLOTTED: 3, 4, 5, 6, 7 mm</li> <li>3PC PHILLIPS: PH1, PH2, PH3</li> <li>3PC POZI: PZ1, PZ2, PZ3</li> <li>4PC METRIC HEX: H3, H4, H5, H6</li> <li>3PC SQUARE: #1, #2, #3</li> <li>6PC STAR: T10, T15, T20, T25, T27, T30</li> </ul>
2	SCREWDRIVER BIT	50 mm
1	COMPACT SCREW GUIDE	80 mm Long
2	MAGNETIC NUT SETTER	6.8 mm

29pcs



Art. No. 157792  
EAN: 3800123169571



**SCREWDRIVER BITS 1/4" 37 PCS SET**

[BG] Накрайници 37 броя комплект • [RO] Set biti 37 buc • [SR] Pin Set 37 kom • [MK] Битови, Сет 37 Пар • [RU] Набор бит 37 пр • [SL] Set bit-nastavkov 37-delni komplet • [EL] Σет μύτες 37 τεμαχίων σε κασετίνα • [HR] Set bitovi 37 kom • [FR] Embouts de tournevis 37 pièces • [IT] Set di cacciaviti 37 pezzi • [ES] Destornillataj Bitoj 37 Pcs-Aro • [PT] Chave de fenda 37 Pcs Set Bitoj

pcs	Name	Sizing
8	50 mm (L) BIT	<ul style="list-style-type: none"> <li>2PC SLOTTED: 5.5, 8 mm</li> <li>3PC PHILLIPS: PH1, PH2, PH3</li> <li>3PC POZI: PZ1, PZ2, PZ3</li> </ul>
24	25 mm(L) BIT	<ul style="list-style-type: none"> <li>5PC SLOTTED: 3, 4, 5, 6, 7mm</li> <li>3PC PHILLIPS: PH1, PH2, PH3</li> <li>3PC POZI: PZ1, PZ2, PZ3</li> <li>4PC METRIC HEX: H3, H4, H5, H6</li> <li>3PC SQUARE: #1, #2, #3</li> <li>6PC STAR: T10, T15, T20, T25, T27, T30</li> </ul>
4	NUT DRIVER	5, 6, 8, 10 mm
1	BIT HOLDER	

37pcs



Art. No. 157793  
EAN: 3800123169588



**SCREWDRIVER BITS & DRILL BITS 1/4" 15 PCS SET**

[BG] Накрайници и свредла 1/4" 15 броя комплект • [RO] Set burghie si biti 15 buc • [SR] Pinovi i burgije Set 15 kom • [MK] Битови и Бургие, Сет 15 Пар • [RU] Набор бит и сверл 15 пр • [SL] 15-delni set svedrli in vijačni nastavki • [EL] Σет μύτες τρυπάνια 15 τεμαχίων • [HR] SET bitovi i svrdla 15 kom • [FR] Embouts de tournevis et embouts 1/4 "15 pièces • [IT] Giraviti e punte da trapano Set da 1/4 "15 pezzi • [ES] Disilador Bits & Drill Bits 1/4 "15 komputiloj • [PT] Chave de fendas e brocas 1/4 "15 peças

15pcs

pcs	Name	Sizing
7	HSS DRILL BITS WITH HEX SHANK	Ø1.5, 2.0, 3.0, 4.0, 4.5, 5.0, 6.0 mm
7	50mm (L) BIT	<ul style="list-style-type: none"> <li>2PC SLOTTED: 4, 5 mm</li> <li>2PC PHILLIPS: PH2 x 2</li> <li>2PC POZI: PZ2 x 2</li> <li>1PC SQUARE: #2</li> </ul>
1	MAGNETIC HOLDER	58 mm



Art. No. 157795  
EAN: 3800123169601



**SCREWDRIVER BITS & DRILL BITS 1/4" 20 PCS SET**

[BG] Накрайници и свредла 1/4" 20 броя комплект • [RO] Set burghie si biti 20 buc • [SR] Pinovi i burgije Set 20 kom • [MK] Битови и Бургие, Сет 20 Пар • [RU] Набор бит и сверл 20 пр • [SL] 20-delni set svedrli in vijačni nastavki • [EL] Σет μύτες τρυπάνια 20 τεμαχίων • [HR] SET bitovi i svrdla 20 kom • [FR] Embouts de tournevis et embouts 1/4 "20 pièces • [IT] Giraviti e punte da trapano Set da 1/4 "20 pezzi • [ES] Disilador Bits & Drill Bits 1/4 "20 komputiloj • [PT] Chave de fendas e brocas 1/4 "20 peças

20pcs

pcs	Name	Sizing
7	HSS DRILL BITS WITH HEX SHANK	Ø1.5, 2.0, 3.0, 4.0, 4.5, 5.0, 6.0 mm
9	50mm (L) BIT	<ul style="list-style-type: none"> <li>3PC SLOTTED: 4, 5, 6 mm</li> <li>3PC PHILLIPS: PH1, PH2, PH3</li> <li>3PC POZI: PZ1, PZ2, PZ3</li> </ul>
3	NUT DRIVER	6, 8, 10mm
1	QUICK CHANGER	



Art. No. 157797  
EAN: 3800123169625



**SCREWDRIVER BITS & MAGNETIC HOLDER QUICK-CHANGE**

[BG] Накрайници и магнитен държач бърз захват 1/4" 15 бр. к-т RAIDER • [RO] Set biti 15 buc • [SR] Pin Set 15 kom • [MK] Битови, Сет 15 пар • [RU] Набор бит 15 пр • [SL] Set bit-nastavkov 15-delni komplet • [EL] Σет μύτες 15 τεμαχίων σε κασετίνα • [HR] Set bitovi 1/4 "15 kom • [FR] Embouts de tournevis et support magnétique à changement rapide 1/4 "Set de 15 pièces • [IT] Set di cacciaviti e supporto magnetico Set rapido 1/4 "15 pezzi • [ES] Nozzles kaj magneta posedanto fastas 1/4 "15 komputiloj • [PT] Bicos e suporte magnético fixam 1/4 "15 peças

pcs	Sizing
14	25mm(L) BIT
	<ul style="list-style-type: none"> <li>3PC SLOTTED: 4, 5, 6</li> <li>2PC PHILLIPS: PH1, PH2</li> <li>2PC POZI: PZ1, PZ2</li> <li>3PC HEX: 3, 4, 5</li> <li>4PC T10, T15, T20, T30</li> </ul>
1	ADAPTOR MAGNET QUICK RELEASE



1/4" 15 PCS. SET



Art. No. 158903  
EAN: 3800123171703



**SCREWDRIVER BITS & MAGNETIC HOLDER QUICK-CHANGE 1/4" 32 PCS. SET**

[BG] Накрайници и магнитен държач бърз захват 1/4" 32 бр. к-т RAIDER • [RO] Set biti 32 buc • [SR] Pin Set 32 kom • [MK] Битови, Сет 32 пар • [RU] Набор бит 32 пр • [SL] Set bit-nastavkov 32-delni komplet • [EL] Σет μύτες 32 τεμαχίων σε κασετίνα • [HR] Set bitovi 1/4 "32 kom • [FR] Embouts de tournevis et support magnétique à changement rapide 1/4 "Set de 32 pièces • [IT] Set di cacciaviti e supporto magnetico Set rapido 1/4 "32 pezzi • [ES] Nozzles kaj magneta posedanto fastas 1/4 "32 komputiloj • [PT] Bicos e suporte magnético fixam 1/4 "32 peças

32pcs

pcs	Sizing
30	25mm(L) BIT
	<ul style="list-style-type: none"> <li>4PCS SLOTTED: 3, 4, 5, 6</li> <li>4PCS PHILLIPS: PH1, PH2, PH3, PH4</li> <li>4PCS POZI: PZ1, PZ2, PZ2, PZ3</li> <li>4PCS HEX: 3, 4, 5, 6mm</li> <li>7PCS T10, T15, T20, T25, T27, T30, T40</li> <li>7PCS: T10, T15, T20, T25, T27, T30, T40</li> </ul>
1	ADAPTOR 25MM FROM 1/4" TO 1/4 SQR.
1	ADAPTOR MAGNET QUICK RELEASE



Art. No. 158901  
EAN: 3800123171680



## ADAPTERS SET 1/4 HEX TO 1/4", 3/8", 1/2" SQUARE 3 PCS.

[BG] Адаптери 3 броя комплект • [RO] Set 3 buc adaptor • [SR] Adapter 3 komada set • [MK] Адаптер 3 парчиња комплект • [RU] Переходник 3 шт набор • [SL] Adapter 3 kosi komplet • [EL] Προσαρμογέας σэт 3 τεμαχίων • [HR] Adapteri 3 komada set • [FR] Kit de 3 adaptateurs • [IT] Adattatori Kit da 3 pezzi • [ES] Adaptiloj 3 pecoј kit • [PT] Kit de 3 peęas para adaptadores

1/4 HEX to  
1/4", 3/8", 1/2" SQ

Art. No. 158904  
EAN: 3800123173486



## SCREWDRIVER BITS & MAGNETIC HOLDER QUICK-CHANGE

• [BG] Накрайници и магнетен държач бърз захват 1/4" 42 бр. к-т RAIDER • [RO] Set biti 42 buc • [SR] Pin Set 42 kom • [MK] Битови, Сет 42 пар • [RU] Набор бит 42 пр • [SL] Set bit-nastavkov 42-delni komplet • [EL] Σет μύτεσ 42 τεμαχίων σт κοσтетiva • [HR] Set bitovi 1/4" 42 kom • [FR] Embouts de tournevis et support magnétique à changement rapide 1/4 "Set de 42 pièces • [IT] Set di cacciaviti e supporto magnetico Set rapido 1/4 "42 pezzi • [ES] Nozzles kaj magneti posedanto fastas 1/4 " 42 komputilojn • [PT] Bicos e suporte magnético fixam 1/4 "42 peças

pcs	Sizing
36	25mm(L) BIT
	● SLOTTED: 4 X 2PCS, 5, 6
	⊕ PHILLIPS: PH1, PH2, PH3 X 3PCS
	⊕ POZI: PZ1, PZ2, PZ3 X 4PCS
	⊙ 3PCS HEX: 3, 4, 5
	⊕ 7PCS T10, T15, T20, T25, T27, T30, T40
	⊕ 7PCS: T10, T15, T20, T25, T27, T30, T40
4	75mm BIT: Sl: 6, PH2, Pozi: PZ2, Torx: T25
1	ADAPTOR 25MM FROM 1/4" TO 1/4 SQR.
1	ADAPTOR MAGNET QUICK RELEASE

1/4"  
42 PCS. SET



Art. No. 158902  
EAN: 3800123171697

## CLAMPING AND WORKING TAB

[BG] Маса работна-менгеме • [RO] Banc de lucru • [SR] Radni sto sklopivi • [MK] Маса работна • [RU] Стол-верстак • [SL] Delovna miza • [EL] Πάγκος εργασίας • [HR] Stezni i radni stol • [FR] Serrage et table de travail • [IT] Morsetto e tavolo di lavoro • [ES] Sujeción y mesa de trabajo. [PT] Fixação e mesa de trabalho

FOLDABLE FOR EASY STORAGE  
Art. No. 139905  
EAN: 38001231119170



Art. No. 139970  
EAN: 3800123171758



## DRILL STAND

• [BG] Стойка за бормашина  
• [RO] Stativ pentru bormasina  
• [SR] Postolje za bušilicu  
• [MK] Држач за дупчалка  
• [RU] Стенд для дрель  
• [SL] Stojalo za vrtalnike  
• [EL] Βάση Δραπάνου  
• [HR] Stalac za bušilicu  
• [FR] Support de foret  
• [IT] Supporto per trapano  
• [ES] Soporte para taladro  
• [PT] Suporte para broca



Art. No. 139201  
EAN: 3800972004054

## ANGLE GRINDER STAND

[BG] Стойка за ъглошлайф • [RO] Stativ pentru polizor unghiular • [SR] Postolje za brusilica ugaona  
• [MK] Држач за брусилка • [RU] Стенд для угловой шлифовальная машина • [SL] Stojalo za kotni brusilnik • [EL] Βάση γωνιακος τροχος • [HR] Stalak za kutnu brusilicu • [FR] Support pour meuleuse d'angle  
• [IT] Supporto per angle grinder • [ES] Soporte para amoladora angular • [PT] Suporte para rebarbadora

Art. No. 139501  
EAN: 3800972004061

Art. No. 139912  
EAN: 3800123126208

115 mm

125 mm



## DRILL STAND VICE DIE CAST BODY

• [BG] Менгеме машинно • [RO] Menghina pentru bormasina • [SR] Stega za stubnu bušilicu  
• [MK] Менгеме за бормашина • [RU] Станочные поворотные тиски • [SL] Primež za namizni vrtalni stroj • [EL] Μεγγενη για την βάση • [HR] Stega za Stupna bušilica • [FR] Support pour meuleuse d'angle • [IT] Morsa girevole della macchina • [ES] Soporte para amoladora angular  
• [PT] Suporte para rebarbadora

L1  
75mm

Art. No. 139914  
EAN: 3800123119132



L1  
100mm

Art. No. 139915  
EAN: 3800123119149

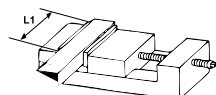

230 mm





**ACCESSORIES FOR MINI GRINDER 100 PCS SET**

[BG] Аксесоари за шлифовалка 100 бр. комплект • [RO] Set accesorii ptr. minipolizor - 100 buc/set • [SR] Set za čišćenje/poliranje 100 kom • [MK] Set dodatoci za Ramna brusilica sa osi 100 kom • [RU] Набор насадок для полировки 100 шт. • [SL] 100-delni komplet za poliranje • [EL] Σετ στίλβωσης 100 τεμ • [HR] Nastavci za brušenje 100 kom • [FR] Accessoires pour Mini Grinder 100 pcs Set • [IT] Accessori per Mini Grinder Set 100 pezzi • [ES] Accesorios para Mini Grinder 100 piezas Set • [PT] Acessórios para Mini Grinder 100 pcs Set



Art. No. 139901  
EAN: 3800123124969



**FLEXIBLE SHAFT FOR MINI GRINDER**

[BG] Жило за шлифовалка • [RO] Arbore flexibil ptr. minipolizor • [SR] Fleksibilna osovina za brusilica • [MK] Флексибилно вратило за брусилка • [RU] Гибкий вал для мини шлифмашина • [SL] Gibljivo gredjo za mini brusilnik • [EL] Εύκαμπτο άξονα για μίνι τροχό • [HR] Fleksibilno vratilo za brusilica • [FR] Arbre flexible pour mini meuleuse • [IT] Albero flessibile per Mini Grinder • [ES] Fleksebla Selo por Mini Muelillo • [PT] Eixo Flexível para Mini Moedor



Art. No. 138403  
EAN: 3800123170768

**CARBIDE ENGRAVING FLAT TIP FOR RD-ENGO 1**

[BG] Накрайник карбиден с плосък връх • [RO] Freze pantograf proxhon Carbid • [SR] Vrh za graviranje karbidni • [MK] Бит за гравирање карбид • [RU] Карбидная гравировальная насадка • [SL] Bit za graviranje • [EL] Μύτεσ χάρδης κορβιδίου • [HR] Vrh za graviranje karbidni • [FR] Pointe de gravure au carbure • [IT] Punta piatta per incisione in carburo • [ES] Carbide Grabado Flat Tip • [PT] Ponta plana de gravação de metal duro



Art. No. 138405  
EAN: 3800123173035

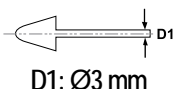

D1: Ø3 mm



**DIAMOND BURRS 30 PCS SET**

[BG] Борчета диамантени 30 бр. комплект • [RO] Set 30 buc ace pentru slefuit biax • [SR] 30-delni set glodala dijamantski • [MK] Дијамантски Уметок Set 30 ком • [RU] Заусенцы диаманта набор 30 шт. • [SL] Rezkari - diamantrni komplet 30 kos • [EL] Σετ Διαμόντια φρέζες 30 τεμ • [HR] Nastavci za brušenje dijamantni 30 kom • [FR] Set de 30 fraises diamantées • [IT] Diamond Burrs Set da 30 pezzi • [ES] Diamond Burrs 30 piezas Set • [PT] Brocas de diamante 30 peças



PLASTIC BOX WITH COVER

Art. No. 157708  
EAN: 3800123121340

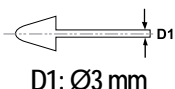

D1: Ø3 mm



**ROTARY RASP FILE 5 PCS SET**

[BG] Борчета за дърво • [RO] Set 5 buc raspile pentru slefuit biax • [SR] 5-delni set glodala za drvo • [MK] Уметок за дрво Set 5 ком • [RU] Заусенцы для дерева набор 5 шт. • [SL] Rezkari komplet 5 kos • [EL] Σετ φρέζες 5 τεμ • [HR] Nastavci za brušenje 5 kom • [FR] Bavettes pour le bois mis 5 pcs. • [IT] Bave per legno set 5 pezzi • [ES] Conjunto rebabas para madera 5 uds. • [PT] Rebarbas para madeira set 5 pcs.



Art. No. 159902  
EAN: 3800123121319

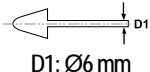

D1: Ø6 mm

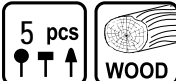

**ACCESSORIES FOR MINI GRINDER 249 PCS SET**

[BG] Аксесоари за шлифовалка 249 бр. комплект • [RO] Set accesorii ptr. minipolizor - 249 buc/set • [SR] Set za čišćenje/poliranje 249 kom • [MK] Set dodatoci za Ramna brusilica sa osi 249 kom • [RU] Набор насадок для полировки 249 шт. • [SL] 249-delni komplet za poliranje • [EL] Σετ στίλβωσης 249 τεμ • [HR] Nastavci za brušenje 249 kom • [FR] Accessoires pour Mini Grinder 100 pcs Set • [IT] Accessori per Mini Grinder Set 100 pezzi • [ES] Accesorios para Mini Grinder 100 piezas Set • [PT] Acessórios para Mini Grinder 100 pcs Set



Art. No. 138402  
EAN: 3800123170751



**CARBIDE ENGRAVING POINT TIP FOR RD-ENGO 1**

[BG] Накрайник карбиден с остър връх • [RO] Freze pantograf proxhon Carbid • [SR] Vrh za graviranje karbidni • [MK] Бит за гравирање карбид • [RU] Карбидная гравировальная насадка • [SL] Bit za graviranje • [EL] Μύτεσ χάρδης κορβιδίου • [HR] Vrh za graviranje karbidni • [FR] Pointe de gravure au carbure • [IT] Punta del punto di incisione in carburo • [ES] Carbide Gravura Punto Tip • [PT] Ponta de gravação de carboneto



Art. No. 138404  
EAN: 3800123173028

**DIAMOND BURRS 20 PCS SET**

[BG] Борчета диамантени 20 бр. комплект • [RO] Set 20 buc ace pentru slefuit biax • [SR] 20-delni set glodala dijamantski • [MK] Дијамантски уметок сет 20 ком • [RU] Заусенцы диаманта набор 20 шт. • [SL] Rezkari - diamantrni komplet 20 kos • [EL] Σετ Διαμόντια φρέζες 20 τεμ • [HR] Nastavci za brušenje dijamantni 20 kom • [FR] Jeu de 20 fraises diamantées • [IT] Diamond Burrs Set da 20 pezzi • [ES] Diamond Burrs 20 piezas Set • [PT] Diapasão 20 unidades



Art. No. 157709  
EAN: 3800123121333

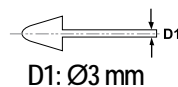

D1: Ø3 mm



**MOUNTED GRINDING POINT 5 PCS SET**

[BG] Борчета абразивни • [RO] Set 5 buc pietre slefuit pentru bormasina • [SR] Brusni kamen set 5kom • [MK] Сет абразивен камен 5 ком • [RU] Каменные боры набор 5 шт. • [SL] Brusilni čepi komplet 5 kos • [EL] Σετ Πέτρες τροχ(στματοσ από οξείδιο αργιλίου 5 τεμ • [HR] Nastavci za brušenje 5 kom • [FR] Point de meulage monté, 5 pièces • [IT] Set di 5 pezzi per smerigliatrice montata • [ES] Juego de 5 puntos de molinda montada • [PT] Ponto de moagem montado 5 pcs Set

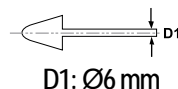

D1: Ø6 mm



Art. No. 159903  
EAN: 3800123121104

**ADAPTER SDS-PLUS TO CHUCK**

[BG] Адаптер SDS-plus за патронник • [RO] Adaptor mandrina SDS-PLUS • [SR] Adapter SDS-plus • [MK] Адаптер SDS-plus за пречник • [RU] Переходник для патрона SDS-Plus • [SL] Adapter SDS-plus za vrtalna glava • [EL] Στελεχος υποδοχής sds plus για ττοκ • [HR] Adapter stezne glave • [FR] Adapteur SDS-plus au mandrin • [IT] Adattatore SDS-plus a Chuck • [ES] Adaptador SDS-plus a Chuck • [PT] Adaptador SDS-plus para Chuck



Art. No. 159901  
EAN: 3800123125607



## DRILL CHUCK KEYLESS 2 PLASTIC SLEEVE

[BG] Патронник за бормашина самозатягащ пластм. • [RO] Mandrina rapida • [SR] Stezna glava plast. brzostezuća • [MK] Стезна глава [RU] Патрон дря дрели без ключа • [SL] Vrtna glava samozatezna • [EL] Τροχ δρατάνου αυτόματο • [HR] Brzostezna glava • [FR] Mandrin de perçage sans clé • [IT] Mandrino autoserrante • [ES] Boru bastanon • [PT] Mandril de brocas sem chave

### FOR RD-KC01

Art. No. 139906  
EAN: 3800123123931

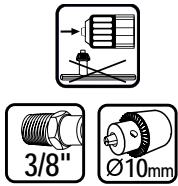

### + ADAPTER 1/4"

Art. No. 139003  
EAN: 3800123163814

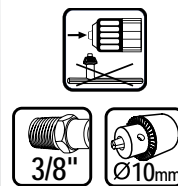

Art. No. 139908  
EAN: 3800123139488

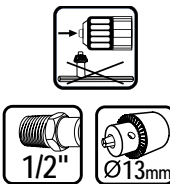

### SLEEVE PLASTIC, REAR SLEEVE METAL

Art. No. 139943  
EAN: 3800123150203

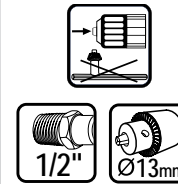

### METAL SLEEVE WITH CLICK FOR RD-KC11

Art. No. 139942  
EAN: 3800123149870

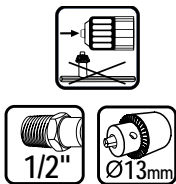

### CHUCK KEY FOR DRILL CHUCK

[BG] Ключ за патронник на бормашина • [RO] Cheie mandrina • [SR] Ključ za steznu glavu bušilice • [MK] Ключ за стезна глава • [RU] Ключ для патрона • [SL] Ključ za vrtna glava • [EL] Κλειδί για τροχ • [HR] Ključ za Stezna glava • [FR] Clé de mandrin pour mandrin • [IT] Chiave per mandrino • [ES] Llave de sujeción de tornillo • [PT] Chave de aperto de parafuso

art. №	for model	Ø (mm)	BARCODE
139903	RD-KC08	13	3800123126260
139904	RD-KC15	16	3800972014329



### DRILL CHUCK WITH KEY

[BG] Патронник за бормашина с ключ • [RO] Mandrina cu cheie • [SR] Stezna glava • [MK] Стезна глава со ключ • [RU] Патрон дря дрели с ключа • [SL] Vrtna glava • [EL] Τροχ δρατάνου με κλειδί • [HR] Stezna glava s ključem • [FR] Mandrin de perçage avec clé • [IT] Stezna Head con Kluch • [ES] Triluču Chuck kun Šlosilo • [PT] Capitulo Stesna com

art. №	for model	Ø (mm)	BARCODE
139001	RD-KC13	16	3800123162138
139002	RD-KC14	13	3800123162862
139907	RD-KC03	13	3800123126253



### +SDS-PLUS CHUCK ADAPTER KIT

Art. No. 999902  
EAN: 3800123123627

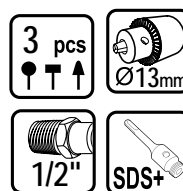

### DRILL CHUCK CONE WITH KEY

art. №	for model	Ø (mm)	B	BARCODE
139921	RD-KC04	13	16	3800123124792
139922	RD-KC05	16	16	3800123124808
139925	RD-KC06	20	22	3800123124730



### DRILL CHUCK 13MM QUICK CHANGE FOR RDP-CDL21

Art. No. 139006  
EAN: 3800972014572



### ECCENTRIC ADAPTOR QUICK CHANGE FOR RDP-CDL21

Art. No. 139007  
EAN: 3800972015173



### ANGLE ADAPTOR QUICK CHANGE FOR RDP-CDL21

Art. No. 139005  
EAN: 3800972014565





## PAINT MIXER HEX

[BG] Бъркалка за боя • [RO] Mixer vopsea • [SR] Mešač • [MK] Мешалка за боја • [RU] Миксер для краски металлический • [SL] Barve mešalnikom • [EL] Αναδευτήρας χρωμάτων • [HR] Mješač • [FR] Mélangeur de peinture • [IT] Miscelatore di vernice • [ES] Mezclador de pintura • [PT] Misturador de tinta

art. №	D1 (mm)	D2 (mm)	D3 (mm)	BARCODE
329901	Ø80	400	8 HEX	3800123126239
329902	Ø100	600	10 HEX	3800123126246

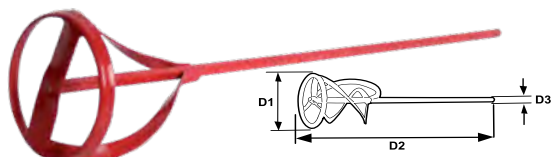

## MIXING PADDLE

[BG] Бъркалка • [RO] Mixer vopsea • [SR] Mešač • [MK] Мешалка • [RU] Миксер металлический • [SL] Mešalnikom • [EL] Αναδευτήρας • [HR] Mješač • [FR] Pagaia • [ES] Mezclador • [PT] Mixer

art. №	D1 (mm)	D2 (mm)	D3 (mm)	BARCODE
329925	Ø80	400	8 HEX	3800123127793
329926	Ø100	600	10 HEX	3800123127809

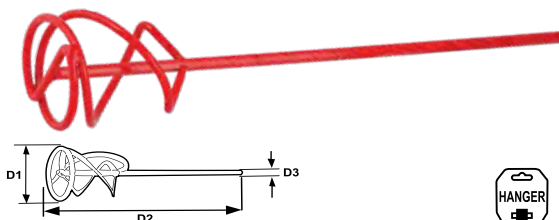

## MIXING PADDLE

[BG] Бъркалка • [RO] Mixer vopsea • [SR] Mešač • [MK] Мешалка • [RU] Миксер металлический • [SL] Mešalnikom • [EL] Αναδευτήρας • [HR] Mješač • [FR] Pagaie de mélange avec spirale plate [IT] Paletta di miscelazione con spirale piatta • [ES] Paleta Mezcladora • [PT] Misturando paddle

## MIXING PADDLE WITH FLAT SPIRAL

art. №	D1 (mm)	D2 (mm)	D3 (mm)	BARCODE
329927	Ø100	600	10 HEX	3800123127816
329928	Ø120	600	10 HEX	3800123127823

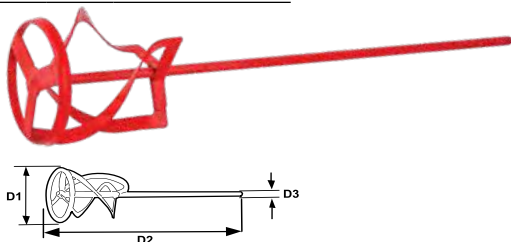

## MIXING PADDLE SDS-PLUS

art. №	D1 (mm)	D2 (mm)	D3 (mm)	BARCODE
329935	Ø80	400	10 SDS+	3800123151224
329936	Ø100	600	10 SDS+	3800123151231

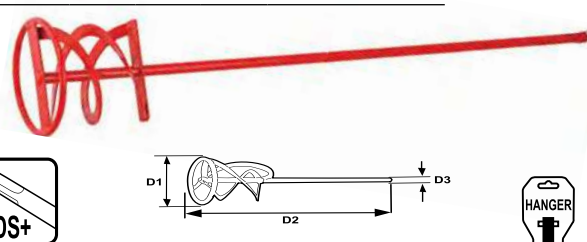

## MIXING PADDLE FOR POWER MIXER

art. №	D1 (mm)	D2 (mm)	D3 (mm)	BARCODE
329924	Ø120	600	M14	3800123127786

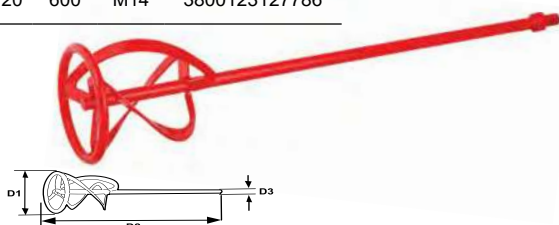

## MIXING PADDLE ZINC PLATED

[BG] Бъркалка поцинкована за боя • [RO] Mixer zincat pentru vopsea • [SR] Mešač pocinkovan za boja • [MK] Мешалка поцинкувана за боја • [RU] Миксер металлический • [SL] Mešalnikom pocinkana • [EL] Αναδευτήρας γαλβανιζέ • [HR] Mješač pocinčane za boja • [FR] Mélangeur galvanisé pour peinture • [IT] Miscelatore zincato per vernice • [ES] Mezclador galvanizado para pintura • [PT] Mezclador galvanizado para pintura

## MIXING PADDLE ZINC PLATED HEX

art. №	D1 (mm)	D2 (mm)	D3 (mm)	BARCODE
138501	Ø80	400	8 HEX	3800123166297
138502	Ø80	400	8 HEX	3800123166303
138503	Ø100	600	10 HEX	3800123166310

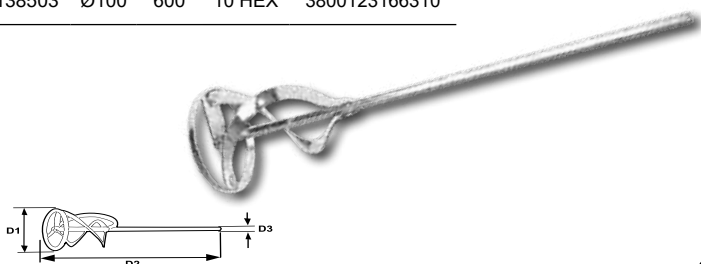

## MIXING PADDLE SDS-PLUS ZINC PLATED

art. №	D1 (mm)	D2 (mm)	D3 (mm)	BARCODE
138504	Ø80	400	SDS+	3800123166327
138505	Ø100	600	SDS+	3800123166334

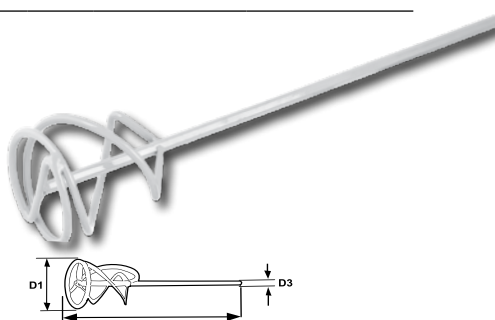

## MIXING PADDLE FOR ELECTRIC POWER MIXER

[BG] Бъркалка поцинкована за електрически миксер • [RO] Mixer zincat • [SR] Mešač pocinkovan • [MK] Мешалка поцинкована • [RU] Миксер металлический • [SL] Mešalnik pocinkana • [EL] Αναδευτήρας γαλβανιζέ • [HR] Mješač pocinčane • [FR] Mélangeur zingué électrique • [IT] Miscelatore zincato elettrico • [ES] Mezclador chapado en zinc eléctrica • [PT] Misturador zincado eléctrica

## MIXING PADDLE FOR ELECTRIC POWER MIXER ZINC PLATED

art. №	D1 (mm)	D2 (mm)	D3 (mm)	BARCODE
138506	Ø120	600	M14	3800123166341

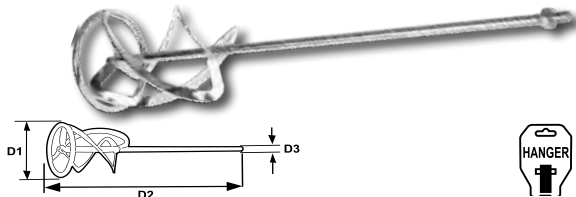

## MIXING PADDLE FOR ELECTRIC POWER MIXER WITH 2 PADDLES ZINC PLATED

art. №	D1 (mm)	D2 (mm)	D3 (mm)	BARCODE
138507	Ø125	600	13 HEX	3800972012615

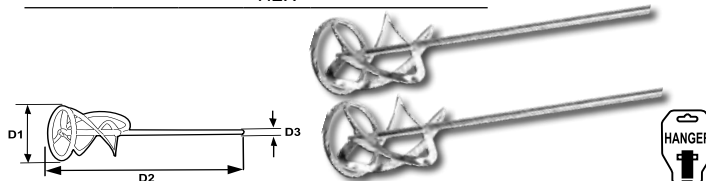

## RUBBER BACKING DISK FOR ANGLE GRINDER

[BG] Диск гумен за ъглошлайф • [RO] Suport circular cauciuc • [SR] Nosač brusnog papira gumeni • [MK] Гумен диск за абразивна хартија за брусилка • [RU] Резиновый диск для угловая шлифовальная машина • [SL] Podložak fiber gumena za kotni brusilnik • [EL] Μαξιλάρι δρασπάνου λαοστιχένιο • [HR] Gumena ploča za Kutna brusilica • [FR] Caoutchouc à disque pour meuleuse d'angle • [IT] Disco in gomma per smerigliatrice angolare • [ES] Disco de goma para amoladora angular • [PT] Borracha de disco para rebarbadora

Ø 180mm

Art. No. 139920  
EAN: 3800123135781

FOR ANGLE GRINDER

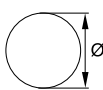

## RUBBER BACKING DISK VELCRO UNIVERSAL

[BG] Диск VELCRO универсален • [RO] Suport din cauciuc disc VELCRO universal • [SR] Nosač Disk VELCRO univerzalan • [MK] Гумена диск VELCRO универзална • [RU] Резиновый диск VELCRO универсальный • [SL] Gumijasta podlogka disk VELCRO • [EL] Υποστηρικτικός δίσκος από καουτσούκ δίσκο VELCRO Παγκόσμιος • [HR] Gumena podloga Disk VELCRO univerzalana • [FR] Disque support en caoutchouc VELCRO universel • [IT] Supporto in gomma Disco VELCRO universale • [ES] Kaūča apogilo Disko VELCRO universal • [PT] Disco protetor de borracha VELCRO universal

art. №	Ø (mm)	BARCODE
139971	Ø115	3800972002241
139972	Ø125	3800972002258

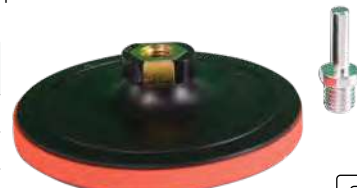

## RUBBER BACKING DISK VELCRO FOR ANGLE GRINDER

[BG] Диск гумен за ъглошлайф VELCRO • [RO] Suport circular cauciuc VELCRO • [SR] Nosač brusnog papira gumeni VELCRO • [MK] Гумен диск за абразивна хартија за брусилка • [RU] Резиновый диск для угловая шлифовальная машина • [SL] Podložak fiber gumena za kotni brusilnik • [EL] Μαξιλάρι δρασπάνου λαοστιχένιο • [HR] Gumena ploča za Kutna brusilica • [FR] Disque de support en caoutchouc VELCRO pour meuleuse d'angle • [IT] Disco in gomma VELCRO per smerigliatrice angolare • [ES] Kaūča apogio Disk VELCRO por angula muelillo • [PT] Disco de apoio de borracha VELCRO para rebarbadora

Ø 180mm

Art. No. 139924  
EAN: 3800123126062

FOR ANGLE GRINDER

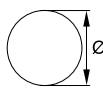

VELCRO



## LAMBSWOOL POLISHING BONNET FOR POLISHER

[BG] Кече за полиршина • [RO] Rezerva poliat • [SR] Navlaka za poliranje jagnjeće vune • [MK] Волнен пад за полирка • [RU] Круг полировальный (натуральная овчина) на липучке • [SL] Krzno za poliranje spužvasto • [EL] Μάλλινος σκούφος για στιλβωτές • [HR] Vuneni jastučić • [FR] Bonnet de polissage en laine d'agneau pour polisseuse • [IT] Cappellino per lucidatura Lambswool per lucidatrice • [ES] Lambswool poluranta tuneton por polisher • [PT] Boné de polimento de lâ de cordeiro para polidor

art. №	Ø (mm)	BARCODE
209934	125	3800123150692
209935	180	3800123150708
209914	240	3800123107313

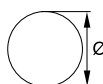

## POLISHING KIT DISC VELCRO, LAMBSWOOL POLISHING BONNET, SPONGE

[BG] К-т за пастиране блокче, кече, гъба • [RO] 3Pcs/ Set polisare • [SR] Set za poliranje 3 kom • [MK] Сет за полирање 3 бројот • [RU] Набор насадок для полировки 3 шт. • [SL] 3-delni komplet za poliranje • [EL] Σετ στιλβωσης 3 τεμ • [HR] Vuneni jastučić, Spužvasti jastučić, Brusni disk • [FR] Kit de polissage disque, Bonnet de polissage en laine d'agneau, Eponge • [IT] Disco per lucidatura V, cuffia per lucidatura in lana d'agnello, spugna • [ES] Poluranta kitran diskon, Lambswool Poluranta Bonneton, Spongon • [PT] Kit de polimento disc, boné de polimento lambswool, esponja

Art. No. 499976  
EAN: 3800123150715

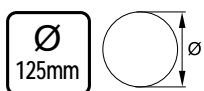

## POLISHING SPONGE

[BG] Гъба за полиране • [RO] Buretele de lustruit • [SR] Spužva za poliranje • [MK] Полирање сунѓер • [RU] Полировка губки • [SL] Gobica za poliranje • [EL] Σφουγγάρι στιλβωσης • [HR] Spužva za poliranje • [FR] Éponge à polir • [IT] Spugna per lucidare • [ES] Polura spongo • [PT] Esponja de polimento

Art. No. 155801  
EAN: 3800972016620

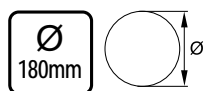

**NEW PRODUCT**





**FLAT TAPERED SCYTHE STONE GREY**

[BG] Брус овален сив • [RO] Piara pentru ascutit coasa • [SR] Kamen za oštrenje • [MK] Камен за оштрење на коса • [RU] Точильный камень • [SL] Brus za ostrenje • [EL] Πέτρα Ακονίσματος • [HR] Brusni kamen • [FR] Scythe plate, gris pierre • [IT] Pietra squadrata affusolata grigia • [ES] Ebena Blanca Štono • [PT] Cinza de pedra afilado liso da foice

Art. No. 499961  
EAN: 3800123136412



**COMBINATION SHAPE STONE WHITE & GREY**

[BG] Брус комбиниран бяло и сиво • [RO] Piatra dreptunghiulara pentru ascutit cutite • [SR] Kamen za oštrenje kompozitni • [MK] Брусен камен комбиниран • [RU] Точильный камень составной • [SL] Brus za ostrenje kompozitni • [EL] Πέτρα ακονίσματος σύνθετος • [HR] Brusni kamen • [FR] Combinaison forme pierre blanche et grise • [IT] Combinazione di forma pietra bianca e grigia • [ES] Kombina forma štono blanka kaj griza • [PT] Combinação em forma de pedra branca e cinza

200x50x25mm

Art. No. 499958  
EAN: 3800123136382



**COMBINATION SHAPE STONE PINK & GREY**

[BG] Брус комбиниран розово и сиво • [RO] Piatra dreptunghiulara pentru ascutit cutite • [SR] Kamen za oštrenje kompozitni • [MK] Брусен камен комбиниран • [RU] Точильный камень составной • [SL] Brus za ostrenje kompozitni • [EL] Πέτρα ακονίσματος σύνθετος • [HR] Brusni kamen • [FR] Combinaison forme pierre rose & gris • [IT] Combinazione shape stone pink & grey • [ES] Kombina shape stone rozkolora & griza • [PT] Combinação forma pedra rosa e cinza

200x50x25mm

Art. No. 499959  
EAN: 3800123136399



**GRINDING WHEEL**

[BG] Диск за шмиргел • [RO] Piatra ptr polizor • [SR] Brusni kamen • [MK] Брусни камен бел • [RU] Круг шлифовальный • [SL] Brusilni kamen • [EL] Πέτρα λείανσης (χοντρή) • [HR] Brusna ploča za dvostruke brusilice • [FR] Meule blanche • [IT] Mola bianca • [ES] Muelanta Radon Blanca • [PT] Rebolo branco

**GRINDING WHEEL WHITE**

art. №	∅ (mm)	D1 (mm)	D2 (mm)	P	BARCODE
165121	200	16	20	P60	3800123127533

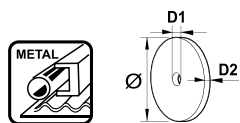

**GRINDING WHEEL GREY**

art. №	∅ (mm)	D1 (mm)	D2 (mm)	P	BARCODE
165119	150	13	16	P36	3800123127519
165120	150	13	16	P80	3800123127526
165123	200	16	20	P60	3800123127557
165124	200	20	40	P60	3800123127564

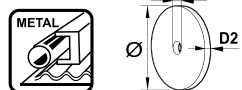

**GRINDING WHEEL GREEN**

art. №	∅ (mm)	D1 (mm)	D2 (mm)	P	BARCODE
165122	200	16	20	P60	3800123127540

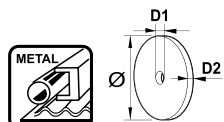

**GRINDING WHEEL RED**

art. №	∅ (mm)	D1 (mm)	D2 (mm)	G	BARCODE
165126	75	10	20	G120	3800123171840

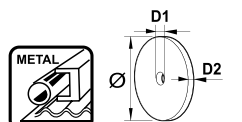

**POLISHING WHEEL**

art. №	∅ (mm)	D1 (mm)	D2 (mm)	PVE	BARCODE
165127	75	10	20	400	3800123171857

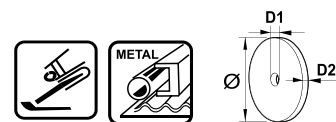

**DISC FOR CHAIN SAW SHARPENER**

art. №	∅ (mm)	D1 (mm)	D2 (mm)	BARCODE
140109	100	10	3.2	3800123163227

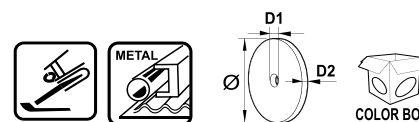

**HAND SANDER**

[BG] Шлайф ръчен • [RO] Suport smirghel • [SR] Nosač brusnog papira • [MK] Држач за шмиргла • [RU] Блок для ручного шлифования • [SL] Ročno brusilni blok • [EL] Μπλοκ για λείανσης • [HR] Ručna brusilica • [FR] Ponceuse à main • [IT] Mano levigatrice • [ES] Muelillo manilbro • [PT] Manual do moedor

art. №	D1 (mm)	D2 (mm)	BARCODE
499986	85	160	3800123157059
499902	100	210	3800123135095



**HAND SANDER WITH HANDLE**

Art. No. 499901  
EAN: 3800123135101



## SOLDER WIRE

[BG] Тинол • [RO] Fludor • [SR] Žica za lemljenje • [MK] Жица за лемење • [RU] Проволочного припоя • [SL] Spajkalna žica • [EL] Κολληση • [HR] Tinol zica za lemljenje • [FR] Fil de soudure • [IT] Filo di saldatura • [ES] Drato de soldo • [PT] Fio de solda

### 60%Sn 40%Pb

art. №	D1 (mm)	weight (g)	BARCODE
209924	1	200	3800123153518
209925	1.6	200	3800123153525



## GLUE STICKS FOR GLUE GUNS

[BG] Силиконови пръчки прозрачни • [RO] Batoane silicon transparent • [SR] Topivi lepak transparentni • [MK] Стапче за лемење • [RU] Набор стержней для клей-пистолета прозрачный • [SL] Lepilne palice, prozorne • [EL] Ράβδοι κόλλας διαφανής • [HR] Silikonski štapići • [FR] Bâtons de silicone transparents • [IT] Bastoncini di silicone trasparente • [ES] Silikaj bastonaj travideblaj • [PT] Varas de silicone transparentes

### GLUE STICKS FOR GLUE GUNS TRANSPARENT

art. №	D1 (mm)	L1 (mm)	weight (g)	BARCODE
156701	7	200	8 pcs	3800123162251
156702	7	200	1000g	3800123162268
209909	11	300	1000g	3800123122354
209910	11	300	6 pcs	3800123122200



### GLUE STICKS FOR GLUE GUNS BLACK

art. №	D1 (mm)	L1 (mm)	weight (g)	BARCODE
156703	7	200	8 pcs	3800123162275
156704	11	200	6 pcs	3800123162282
156705	11	300	1000g	3800123163357

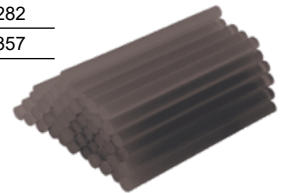

## SOCKET FOR PP PIPE WELDING

[BG] Глава за поялник за PP тръби • [RO] Matrita pt lipit tevi PPR • [SR] Nastavak za peglu za plastične cevi • [MK] Продолжение на Електричен заварувач за пластични цевки • [RU] Насадка для полипропиленовых труб • [SL] Nastavka za Varilnik za PP-R cevi • [EL] Καλούπια για Μηγάνημα συγκόλλησης πλαστικών • [HR] Nastavak za varenje PPR-a • [FR] Douille pour soudage de tubes en PP • [IT] Presa per saldatura tubi in PP • [ES] Socket por PP-tubo-soldado • [PT] Soquete para soldagem de tubos PP

art. №	Ø (mm)	BARCODE
123108	20	3800123151156
123109	25	3800123151163
123110	32	3800123151170
123111	40	3800123151187



## ELECTRODE HOLDER

[BG] Ръкохватка за заваряване с електроди • [RO] Cleste electrozi sudura • [SR] Držac elektrode • [MK] Држач за заварување • [RU] Держатель электродов • [SL] Elektro varilni ročaji • [EL] Τσιμπίδα ηλεκτροδίου • [HR] Držac elektrode za zavarivanje sa oprugom • [FR] Porte-électrode • [IT] Portalettrodo • [ES] Electrodo-posedanto • [PT] Suporte do eletrodo

art. №	A	BARCODE
499923	300	3800123104138
499924	500	3800123104121



COLOR BOX

## EARTH CLAMP

[BG] Щипка за маса за електрожен • [RO] Cleste prindere ptr impamantare • [SR] Klešta za uzemljenje • [MK] Клешта за заземлување • [RU] Зажим для заземления • [SL] Klešče za maso • [EL] Σωμα ηλεκτροσυγκόλλησης • [HR] Klješti za masu • [FR] Pince de terre • [IT] Morsetto di terra • [ES] Trancheja de tero • [PT] Braçadeira da terra

Art. No. 499930  
EAN: 3800123104145

500  
A



COLOR BOX

## ARROW MAGNET WELDING HOLDER

[BG] Магнитен ъгъл държач • [RO] Suport magnetic pentru sudura in unghi • [SR] Stezač magnetskog • [MK] Магнетн ъгъл държач • [RU] Магнитный держатель углов • [SL] Nosilec magnetnega kota • [EL] Μαγνητική γωνιακή βάση • [HR] Stezač magnetskog • [FR] Titulaire d'angle magnétique • [IT] Supporto magnetico per saldatura a freccia • [ES] Magneta angula holder • [PT] Suporte de ângulo magnético

art. №	Size (mm)	Grade 0	Weight (kg)	BARCODE
138340	120x80x14mm	45° 90° 135°	11	3800972009752
138341	155x102x16mm	45° 90° 135°	22	3800972009769
138342	155x76mm	165° 60° 90° 135° 120° 15° 45°	11	3800972009776



Art. No. 130340



Art. No. 130341



Art. No. 130342

NEW  
PRODUCT



BLISTER





## SAW CHAIN

[BG] Верига за резачка • [RO] Lanț pentru ferestrau • [SR] Lanac za lančanu testeru • [MK] Ланец за моторна пила • [RU] Цепь пила • [SL] Veriga za žago • [EL] Αλυσίδα • [HR] Lanac za pila • [FR] Chaîne de scie • [IT] Ha visto la catena • [ES] Vidita Ćeno • [PT] Corrente de serra





### SAW CHAIN FOR GASOLINE CHAIN SAW

art. №				BARCODE
140116 for RDGCS18	3/8"	.050" (1.3mm)	45	3800123174513
140117 for RD-GCS18	3/8"	.050" (1.3mm)	40	3800123174650
140120 for RD-GCS22	.325"	.058" (1.5mm)	60	3800972014343
140105	.325"	.050" (1.3mm)	64	3800123162381
140119 RD-GCS13&14	.325"	.058" (1.5mm)	64	3800972004153
140106	.325"	.050" (1.3mm)	72	3800123162398
140107 for RD-GCS15,19,20,07,08,21	.325"	.058" (1.5mm)	72	3800123162404
140122 for RDP-GCS23	.325"	.058" (1.5mm)	84	3800972015593



COLOR BOX

### SAW CHAIN FOR ELECTRIC CHAIN SAW

art. №				BARCODE
140101	3/8"	.050" (1.3mm)	50	3800123162343
140102 for RD-ECS16X, SBCS20	3/8"	.050" (1.3mm)	52	3800123162350
140103	3/8"	.050" (1.3mm)	56	3800123162367
140104 for RD-ECS17X,18X,19,20,12	3/8"	.050" (1.3mm)	57	3800123162374
140121 for RD-ECS25	3/8"	.050" (1.3mm)	62	3800972015586







COLOR BOX

## GUIDE BAR

[BG] Водач за верига за резачка • [RO] Lama ghidaj pentru drujba • [SR] Vodič lanca za motornu pilu • [MK] Водич за ланец за моторна пила • [RU] Направляющая шина для цепь бензопилы • [SL] Meč za veriga za motorno žago • [EL] Λαμα για αλυσοπριονα • [HR] Vodičica za lanac • [FR] Barre guide • [IT] Barra guida • [ES] Gvidilo trinkejo • [PT] Barra guia







art. №					BARCODE
141306 for RD-GCS18	12" 305mm	3.8"	0.050"(1.3mm)	45	3800123174551
141308 for RD-GCS18	10" 255mm	3.8"	0.050"(1.3mm)	40	3800123174643
141307 for RD-ECS14	14" 355mm	3.8"	0.050"(1.3mm)	52	3800123174568
141311 for RD-GCS22	14" 355mm	0.325"	0.058"(1.5mm)	52	3800972014350
141301 for RD-ECS17X	16" 400mm	3.8"	0.050"(1.3mm)	57	3800123162718
141312 for RD-ECS25	18" 450mm	3.8"	0.050"(1.3mm)	62	3800972015609
141309 for RD-GCS13,14	16" 400mm	0.325"	0.058"(1.5mm)	64	3800972002333
139964 for RD-GCS15,19,20,07,08,21	18" 450mm	0.325"	0.058"(1.5mm)	72	3800123139956
141313 for RD-GCS23	22" 550mm	0.325"	0.058"(1.5mm)	84	3800972015616



COLOR BOX



### GUIDE BAR OREGON

art. №					BARCODE
141314 for RDP-SBCS20	14" 350mm	3/8"	0.050"(1.3mm)	52	3800972015647
141305 for RD-ECS18X,19,20	16" 400mm	3/8"	0.050"(1.3mm)	57	3800123174506



COLOR BOX

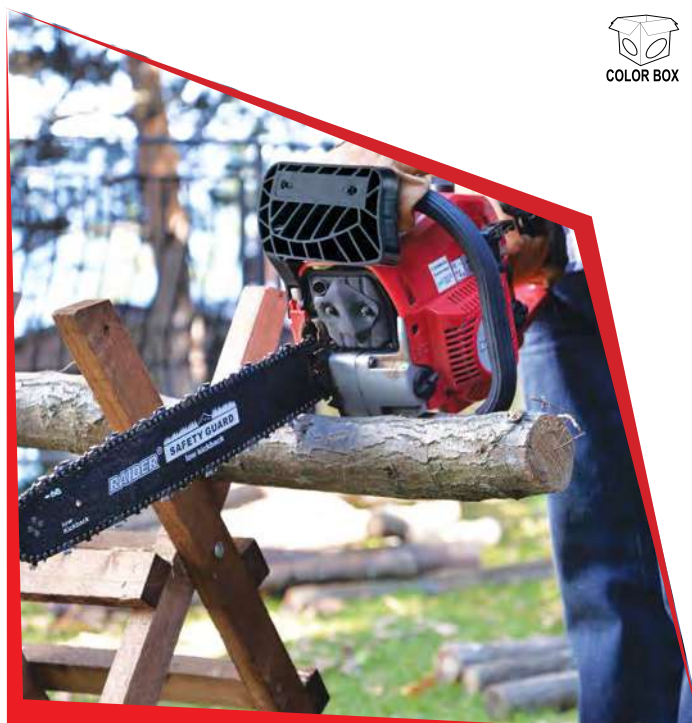

## GREASE GUN WITH GREASE FOR CHAIN SAW

[BG] Такаламит с грес за верижан трион • [RO] Pistol gresare pentru fierastrau cu lant • [SR] Mazalica sa mast za motorna testera • [MK] Мазалица рачна декаламитна за моторна пила • [RU] Шприц для смазки для цепных пилы • [SL] Mazalica za motornih žag • [EL] Γρασοδόρος για βενζινοκίνητο αλυσοπρίοιο • [HR] Mazalica za motorna pila • [FR] Pistolet graisseur avec graisse pour scie à chaîne • [IT] Ingrassare la pistola con grasso per motosega • [ES] Armilo pafilo kun graso por čeno • [PT] Pistola de graxa com graxa para motosserra

Art. No. 141304

EAN: 3800123167423



## FILE FILING GUIDE KIT FOR CHAIN SAW

[BG] Пила с водач комплект за верижан трион • [RO] Kit ascutire lant • [SR] Turpija za lančanu testeru sa vodič set • [MK] Турпија за ланец за моторна пила со водич • [RU] Набор для заточки цепей - напильник и шаблон • [SL] Držalo pile in okrogla pila • [EL] Βάση λίμας με στρογγυλή λίμα • [HR] Držać turpije (uklj. turpija) [FR] Trousse de guide de classement pour scie à chaîne • [IT] Kit di guida per la limatura dei file per motosega [ES] Dosiera ficha gvidilo por čeno • [PT] Kit de guia de arquivamento de arquivo para motosserra

art. №			BARCODE
140112 for electric chain saw	3/8"	4mm	3800123167430
140113 for gasoline chain saw	.325"	4.8mm	3800123167447



## POLISHING GALVANIZED LOG SAW TRESTLE

[BG] Стойка за рязане на дърва • [RO] Suport capra pentru taiat lemne • [SR] Metalni stalak za piljenje • [MK] Држач за сечење на дрва • [RU] Подставка для резания древесины • [SL] Koza za žaganje drv • [EL] Καβαλέτο Κοπής Ξύλων • [HR] Metalni stalak za piljenje • [FR] Tréteau de scie à grumes galvanisé • [IT] Tronchetto per seghe a filo zincato lucidato • [ES] Poluranta galvanan ensaluton rigardis • [PT] Cavalete de serra galvanizado de polimento

Art. No. 140118

EAN: 3800123174704



## TRIMMER LINE

[BG] Корда за косачка тример • [RO] Fir rezerva trimmer • [SR] Najlon za trimer • [MK] Конеч за косилка • [RU] Леска для триммера • [SL] Najlonska nitka za obrezovalnik trave • [EL] Μεσινέζα στρογγυλή • [HR] Najlonska nit Okrugla • [FR] Ligne de coupe pour coupe-herbe ronde • [IT] Trimmer per tosaerba rotondo • [ES] Trimmer-linio por herba trimmer • [PT] Aparador para aparador de grama

### TRIMMER LINE FOR GRASS TRIMMER ROUND

art. №	D1 (mm)	L1 (m)	BARCODE
110208	1.3	15	3800123151811
110210	1.65	15	3800123151859
110204	2.40	15	3800123141706

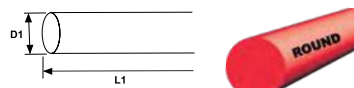

### FORCE STRING TRIMMER LINE FOR BRUSH CUTTERS ROUND

art. №	D1 (mm)	L1 (m)	BARCODE
110236	2.4	260	3800123167416

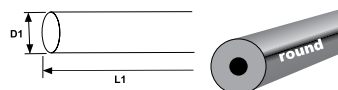

### TRIMMER LINE FOR BRUSH CUTTERS ROUND

art. №	D1 (mm)	L1 (m)	BARCODE
110227	3.0	15	3800123166372

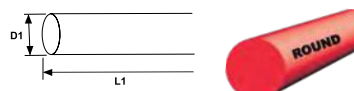

### TRIMMER LINE SQUARE

art. №	D1 (mm)	L1 (m)	BARCODE
110226	3.0	15	3800123166365



### TRIMMER LINE FOR GRASS TRIMMER SQUARE

art. №	D1 (mm)	L1 (m)	BARCODE
110209	1.3	15	3800123151828
110211	1.65	15	3800123151835
110212	2.40	15	3800123151842



### FORCE STRING TRIMMER LINE FOR BRUSH CUTTERS SQUARE

art. №	D1 (mm)	L1 (m)	BARCODE
110280	1.65	15	3800972003880
110281	2.00	15	3800972003897

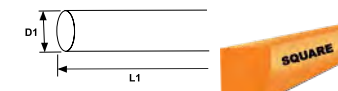



**TRIMMER LINE**

[BG] Корда за косачка тример • [RO] Fir rezerva trimmer • [SR] Najlon za trimer • [MK] Коцењ за косилка • [RU] Леска для триммера • [SL] Najlonska nitka za obrezovalnik trave • [EL] Μεσινέζα στρογγυλή • [HR] Najlonska nit Okrugla • [FR] Ligne de coupe pour coupe-herbe ronde • [IT] Trimmer per tosaerba rotondo • [ES] Trimmer-linio por herba trimmer • [PT] Aparador para aparador de grama

**FORCE STRING TRIMMER LINE FOR BRUSH CUTTERS SQUARE**

art. №	D1 (mm)	L1 (m)	BARCODE
110235	2.4	15	3800123167409

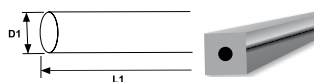

**FORCE STRING TRIMMER LINE FOR BRUSH CUTTERS SQUARE PLATIN SILVER**

art. №	D1 (mm)	L1 (m)	BARCODE
110290	2.7	15	3800972015807
110291	3.0	12	3800972015814

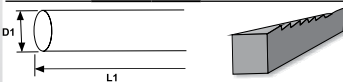

**FORCE STRING TRIMMER LINE FOR BRUSH CUTTERS SQUARE**

art. №	D1 (mm)	L1 (m)	BARCODE
110282	3.0	12	3800972003903
110283	3.5	8	3800972003910
110285	4.0	6	3800972004269
110286	4.5	5	3800972004276

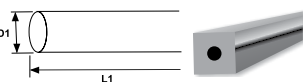

**TRIMMER LINE FOR GRASS TRIMMER TWISTED**

art. №	D1 (mm)	L1 (m)	BARCODE
110248	3.0	28	3800123172090
110249	3.3	46	3800123172106
110250	4.0	32	3800123172113
110251	4.5	25	3800123172120

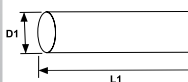

**TRIMMER HEAD FOR BRUSH CUTTERS**

[BG] Корда с тримерна глава за коса • [RO] Mosor cu fir pentru motocosoitoare • [SR] Najlon za trimer • [MK] Коцењ за косилка • [RU] Леска для триммера • [SL] Najlonska nitka za obrezovalnik trave • [EL] Κεφαλή μεσινέζας • [HR] Najlonska rezna glava s dvije niti • [FR] Le cordon avec une tête de cheveux en trois dimensions • [IT] La corda con una testa di capelli tridimensionale • [ES] La Snuro kun tridimensia hararo • [PT] O cabo com uma cabeça de cabelo tridimensional

**TRIMMER HEAD FOR BRUSH CUTTERS**

art. №	D1 (mm)	L1 (m)	BARCODE
110207	2.4	3	3800123143526

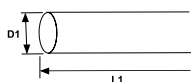

**TRIMMER HEAD FOR ELECTRIC BRUSH CUTTERS**

Art. No. 110273  
EAN: 3800972002227



**UNIVERSAL ALUMINIUM TRIMMER HEAD FOR BRUSH CUTTERS**

Art. No. 110262  
EAN: 3800123174667



**UNIVERSAL TRIMMER HEAD FOR BRUSH CUTTERS**

art. №	D1 (mm)	L1 (m)	BARCODE
110228	2.4	2.5	3800123166389

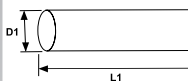

**EASY LOAD TAP&GO TRIMMER HEAD FOR BRUSH CUTTERS**

Art. No. 110234  
EAN: 3800123167638

M10x1.25LH



**BLADE FOR GASOLINE BRUSH CUTTERS 4 TEETH**

[BG] Нож за моторна коса четири лъча • [RO] Cutit cu trei lame pentru motocosoitoare • [SR] Sečivo za trimer 4 kraka • [MK] Нож за бензински тример • [RU] Нож для бензиновый тример - газонокосилка • [SL] Nož za travo za motorna kosa • [EL] Ανταλλακτικός δίσκος 4 δοντιών • [HR] Oštrica 4 zuba • [FR] Couteau de moto à quatre rayons • [IT] Coltello da moto a quattro raggi • [ES] Trancilo de kvar-raketaj motorbikloj • [PT] Faca de moto de quatro feixes

**D1**  
255mm

**D2**  
25.4mm

Art. No. 110229  
EAN: 3800123166396

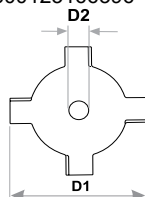

**D1**  
255mm

**D2**  
25.4mm

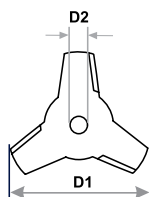

**BLISTER**

## BLADE FOR GASOLINE BRUSH CUTTERS 40 TEETH

[BG] Диск за моторна коса ТСТ • [RO] Disc pentru motocositoare • [SR] List testere za trimer • [MK] Кружна пила за бензински тример • [RU] Циркулярный диск для бензиновый тример - газонокосилка • [SL] Nož za motorna kosa • [EL] Δίσκος πρίονα • [HR] Listova pila • [FR] Lame pour débroussaillieuses à essence 40 dents • [IT] Lama per decespugliatori a benzina 40 denti • [ES] Klingo por Gasoline Brush Cutters • [PT] Lâmina para cortadores de escova a gasolina

Art. No. 110230  
EAN:3800123166402

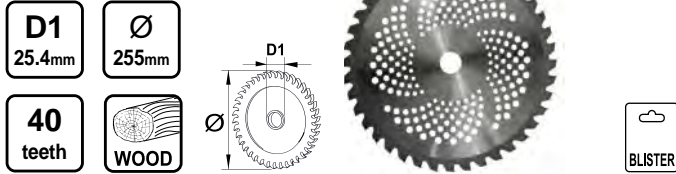

## HARNESS WITH SHOULDER STRAPS

[BG] Самар за моторна коса с широки и меки колани универсален червен • [RO] Harnați cu curelele de umăr padding moale pentru tăietoare perie roșu • [SR] Žarenje sa ramenim kaiševima mekano podlogu za sečenje četkica crveno • [MK] Потпирач со ремени со рамно лежиште за црвени четкички • [RU] Жгут с погонами мягкой подкладки для кусторезов красный • [SL] Zapiraloz z ramenskimi pasovi mehka obloga za rezila za krtače rdeča • [EL] Απολαύστε με ιμάντες ώμου μαλακή επένδυση για κόπτες βούρτσας κόκκινο • [HR] Kabel s trakama za ramena meki padding za crvene četkice • [FR] Samar pour les cheveux moteur avec ceintures larges et douces universels rouge • [IT] Samar per capelli motore con cinghie larghe e morbide universali rosse • [ES] Samar por motoro haroj kun larğaj kaj molaj zonoj universalaj ruğaj • [PT] Samar para cabelos com cintos largos e macios vermelho universal



Art. No. 110284  
EAN:3800972003927



## HARNESS FOR BRUSH CUTTERS

[BG] Самар за моторна коса универсален • [RO] Ham reglabil ptr motocoasa • [SR] Remen za nošenje • [MK] Ранац за бензински тример • [RU] Ременная оснастка • [SL] Standarden oprtnik • [EL] Εξάρτησι • [HR] Univerzalne naramenice • [FR] Harnais pour débroussaillieuses • [IT] Imbracatura per decespugliatori • [ES] Samar por motoro haro universal • [PT] Chicote de fios para cortadores de escova

Art. No. 110231  
EAN:3800123166419



## HARNESS WITH SHOULDER STRAPS & SOFT PADDING FOR BRUSH CUTTERS

[BG] Самар за моторна коса с широки и меки колани универсален • [RO] Ham reglabil ptr motocoasa • [SR] Remen za nošenje • [MK] Ранац за бензински тример • [RU] Ременная оснастка • [SL] Standarden oprtnik • [EL] Εξάρτησι • [HR] Univerzalne naramenice • [FR] Samar pour les cheveux moteur avec ceintures larges et douces universels • [IT] Samar per capelli motore con cinghie larghe e morbide universali • [ES] Samar por motoro haroj kun larğaj kaj molaj zonoj universalaj • [PT] Samar para cabelos com cintos largos e macios universal



Art. No. 110263  
EAN:3800123174674



## TRIMMER LINE ON SPOOL FOR GRASS TRIMMER

[BG] Корда с макара за косачка-тример • [RO] Fir rezerva trimmer • [SR] Najlon za trimmer • [MK] Конец за косилка • [RU] Леска для триммера • [SL] Najlonska nitka za obrezovalnik trave • [EL] Κεφαλή μεσινέζας • [HR] Najlonska rezna glava s dvije niti • [FR] Trimmer Line sur bobine pour tondeuse à gazon • [IT] Il cavo con un mulinello tagliaerba • [ES] La šnuro kun veturilo-trimmerilo • [PT] O cabo com um carreto aparador

art. №	D1 (mm)	L1 (m)	BARCODE
110222 for RD-GT11,20	1.4	3	3800123163975
110223 for RD-GT11,20,26	1.2	3	3800123163982
110260 for RD-GT21			3800123174452

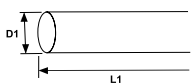

## TRIMMER LINE ON SPOOL WITH CAP FOR GRASS TRIMMER

[BG] Корда с макара и шайба за косачка-тример • [RO] Fir rezerva trimmer cu disc • [SR] Najlon za trimmer • [MK] Конец за косилка • [RU] Леска для триммера • [SL] Najlonska nitka za obrezovalnik trave • [EL] Κεφαλή μεσινέζας • [HR] Najlonska rezna glava s dvije niti • [FR] Trimmer Line sur bobine pour tondeuse à gazon • [IT] Il cavo con un mulinello tagliaerba • [ES] La šnuro kun veturilo-trimmerilo • [PT] O cabo com um carreto aparador

Art. No. 110261  
EAN:3800123174469

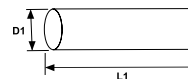

## REFILL PACK WITH 10 SAFETY PLASTIC BLADES FOR CORDLESS GRASS TRIMMER

[BG] Ножчета 10 бр. за акум. тример • [RO] Set 10 lame • [SR] Lezvia 10 komada komplet • [MK] Ножеви 10 парчиња комплет • [RU] Клинки 10 штук комплект • [SL] Rezila 10 kos • [EL] Λεπίδες 10 κομ • [HR] Oštrice 10 komada set • [FR] Recharge de 10 lames en plastique de sécurité pour taille-bordure sans fil • [IT] Confezione di ricarica con 10 lame in plastica di sicurezza per tagliaerba a batteria • [ES] Refill Pack Kun 10 sekurecaj plastaj klingoj por cordless herba trimmer • [PT] Recarga com 10 lâminas de plástico de segurança para aparador de grama sem fio

Art. No. 110252  
EAN:3800123174353



10 pcs  
↑  
↑  
↑

FOR RD-GTL22

## DISC WITH 10 SAFETY PLASTIC BLADES FOR CORDLESS GRASS TRIMMER

[BG] Диск с Ножчета 10 бр. за акум. тример • [RO] Disc cu 10 de lame • [SR] Disk sa Lezvia 10 komada komplet • [MK] Диск со ножеви 10 парчиња комплет • [RU] Диск с Клинки 10 штук комплект • [SL] Disk z Rezila 10 kos • [EL] Δίσκος με Λεπίδες 10 κομ • [HR] Disk sa Oštrice 10 komada set • [FR] Disque avec 10 lames en plastique de sécurité pour taille-bordure sans fil • [IT] Disco con 10 lame in plastica di sicurezza per tagliaerba a batteria • [ES] Disko Kun 10 Sekurecaj Plastaj Klingoj por Cordless Herba Trimmer • [PT] Disco com 10 lâminas de plástico de segurança para aparador de grama sem fio

Art. No. 110253  
EAN:3800123174360



10 pcs  
↑  
↑  
↑

FOR RD-GTL22



## BLADE FOR LAWN MOWER

[BG] Нож за косачка • [RO] Cutit pentru masina de tuns iaba • [SR] Sečivo za kosačica • [MK] Нож за косилка за трава • [RU] Нож для газонокосилки • [SL] Nož za travo za kosilnica • [EL] Αντολλακτικό Μαχαίρι για Χλοοκοπτικό • [HR] Oštrica • [FR] Couteau de tonte • [IT] Coltello falciante • [ES] Tranchilo trançante • [PT] Faca de corte

art. №	L1 (m)	BARCODE
110255 for RD-LM17	320mm (13")	3800123174407
110256 for RD-LM18	350mm (14")	3800123174414
110257 for RD-LM19	420mm (17")	3800123174421
110203 for RD-GLM01	400mm (16")	3800123141584
110264 for RD-GLM04	410mm (17")	3800123174698
110266 for RD-GLM05	460mm (18")	3800123174797
110271 for RD-GLM06	530mm (20")	3800972000346
110278 for RD-LM23	400mm (16")	3800972003637



## GRASS BAG FOR LAWN

[BG] Кош за косачка • [RO] Pungă de iarbă pentru mașină de tuns iarba • [SR] Torba za travu • [MK] Торба за трава за косилка за трава • [RU] Сумка для газонокосилки • [SL] Torba za kosilnico • [EL] Μηχανή γκαζόν • [HR] Kosilica kosh • [FR] Tondeuse à gazon • [IT] Tosaerba • [ES] Lignoçambro • [PT] Saco de grama para cortador de grama

art. №	BARCODE
110277 for RD-LM23	3800972003644
110274 for RD-GLM04	3800972003590
110275 for RD-GLM05	3800972003606
110276 for RD-GLM06	3800972003613



## HOSE FOR HIGH PRESSURE CLEANER

[BG] Маркуч за водоструйка • [RO] Furtun pentru spalator cu presiune • [SR] Crevo visokog pritiska za perač • [MK] Црево за машина за перенје • [RU] Шланг для мойки высокого давления • [SL] Cev za visokotlačni čistilec • [EL] Αποφρακτικός Σωλήνας Υψηλής Πίεσης • [HR] Visokotlačno crijevo za Visokotlačni čistač • [FR] Tuyau 5m pour les travaux d'eau • [IT] Tubo flessibile 5m per acquedotto • [ES] Hose 5m por akvay verkoj • [PT] Mangueira 5m para sistema hidráulico

art. №	Bar	Hose lenght	BARCODE
138101 for RD-HPC01,04	100	5m	3800123158476



art. №	Bar	Hose lenght	BARCODE
139962 for RD-HPC02	140	8m	3800123115813
138121 for RD-HPC07,08	200	8m	3800972016040
138113 for RD-HPC05	120	6m	3800972009974



## GUN FOR HIGH PRESSURE CLEANER

[BG] Пистолет за водоструйка • [RO] Pistol pentru aparat de spalat cu presiune • [SR] Pištolj za perač • [MK] Пиштол за машина за перенје • [RU] Пистолет для мойки высокого давления • [SL] Pištola za pranje • [EL] Πιστόλι για πλυντικό υψηλής πίεσης • [HR] Pištolj za Visokotlačni čistač • [FR] Arme à feu • [IT] Pistola • [ES] Pafilo • [PT] Pistola de ar

art. №	BARCODE
138117 for RD-HPC07,08	3800972016002
138102 for RD-HPC02	3800123158483
138114 for RD-HPC05	3800972009981



art. №	BARCODE
139960 for RD-HPC01,04	3800123115790



## LANCE GUN FOR HIGH PRESSURE CLEANER

[BG] Накрайник за пистолет на водоструйка • [RO] Lance pentru pistol aparat de spalat cu presiune • [SR] Nastavak visokog pritiska za perač • [MK] Спојка за машина за перенје • [RU] Струйная насадка • [SL] Razpršilna šoba za visokotlačni čistilec • [EL] Προεκταση κανής • [HR] Rotacijska mlaznica za Visokotlačni čistač • [FR] Pointe de pistolet hydraulique • [IT] Punta della pistola a pistola idraulica • [ES] Hidráulica pafilo • [PT] Ponta da pistola hidráulica

art. №	BARCODE
138118 for RD-HPC07,08	3800972016019
138103 for RD-HPC01,02,04	3800123158490



art. №	BARCODE
139961 for RD-HPC01,02,04	3800123115806
138116 for RD-HPC05	3800972010000



## ROTARY BRUSH KIT FOR HIGH PRESSURE CLEANER

[BG] Четка ротациона за водоструйка • [RO] Perie pentru aparat de spalat cu presiune • [SR] Četka za perač • [MK] Четка за машина за перенје • [RU] Вращающаяся щетка для мойки высокого давления • [SL] Akumulatorski Vrtnik Vijačnik • [EL] Βούρτσα περιστροφική πλυσιματος γενικής χρήσης για πλυστικά • [HR] Rotirajuća četka za Visokotlačni čistač • [FR] Brosse rotative pour jet d'eau • [IT] Spazzola rotante per getto d'acqua • [ES] Rotacia broso por akvoplugo • [PT] Escova rotativa para jato de água

art. №	BARCODE
138119 for RD-HPC07,08	3800972016026
138105 for RD-HPC01,02,04	3800123158513



## DETERGENT TANK FOR HIGH PRESSURE CLEANER

[BG] Контейнер за препарат за водоструйка • [RO] Cisternă pentru aparat de spalat cu presiune • [SR] Posuda za šampon za perač • [MK] Контейнер за машина за перенје • [RU] Насадка для пенной чистки • [SL] Posodica za detergent • [EL] Απορρυπαντικό με δοχείο • [HR] Mlaznica sa spremnikom deterdženta • [FR] Conteneur pour la préparation au jet d'eau • [IT] Contenitore per la preparazione a getto d'acqua • [ES] Enhavanto por akvoparaparedo • [PT] Recipiente para preparação de jato de água

art. №	BARCODE
138120 for RD-HPC07,08	3800972016033
138104 for RD-HPC01,02,04	3800123158506
138115 for RD-HPC05	3800972009998



## BAG FOR BLOWER VACUUM

[BG] Торба за листосъбирач • [RO] Sac colector • [SR] Preklopna torba za skropljenje • [MK] Преклопна вретена за скрепи • [RU] Складной скребок • [SL] Zložljiva torba za strgalo • [EL] Πτυσσόμενη σακούλα απόξεσης • [HR] Sklopiva vrećica za struganje • [FR] Sac à raclette pliable • [IT] Sacca raschietto pieghevole • [ES] Foldanta kraketa sako • [PT] Saco de raspador dobrável

art. №	L (capacity)	BARCODE
075523 for RD-EBV03	35	3800123173509
075539 for RD-EBV04	35	3800972002067



## BAG FOR GASOLINE BLOWER VACUUM

art. №	L (capacity)	BARCODE
140401 for RD-GBV05	30	3800972003729



## TILE CUTTER BLADE

[BG] Резец За машина за плочки • [RO] Cap taiere placi • [SR] Nož za mašinu zasečenje pločica • [MK] Сечило за машина за сечење на плочки • [RU] Резак машина для резки плитки • [SL] Rezalnik za keramične ploščice • [EL] Κοπής Για Κόφτες Πλακιδίων Χειρός • [HR] Nož za ručna pila, precizna za kut • [FR] Lame de coupe de tuile • [IT] Tagliapiastrelle • [ES] Tondilo de Kahelo • [PT] Lâmina de corte de telha

art. №	Ø (mm)	BARCODE
321518 for RD-TC01,02,03	15x6x1.5	3800123150456
321521 for RD-TC16	16x4x3	3800123104749



art. №	Ø (mm)	BARCODE
321504 for RD-TC10,12,13	15x6x2	3800123116353
321520 for RD-TC11,14,18	22x10.5x2	3800123153938



## NOZZLE, NEEDLE & AIR CAP SET

[BG] Дюза, игла и капачка за боджийски пистолет • [RO] Set duza pentru pistol de vopsit • [SR] Dizna za pu. Pištolj za farbanje • [MK] Резервни прскалки - диза, игла и капа за пиштол за фарбање • [RU] Набор дополнительных сопел (воздушная голова, красочное сопло и игла) для краскопульта • [SL] Šoba za lakirne pištole • [EL] Βελώνια, ακροφύσιο & πώμα αέρος • [HR] Mlaznica za raspršivanje boje set • [FR] Bouchon de buse, aiguille et pistolet à peinture • [IT] Ugello, ago e cappuccio della pistola di vernice • [ES] Nozzle, nadlo kaj pentri pafilon čapo • [PT] Bocal, agulha e tampa de pistola de pintura

art. №	Ø	BARCODE
110907 for RD-SG04	Ø1.5 mm	3800123165399
110909 for RD-SG05	Ø1.2 mm	3800123173042
110908 for RD-SG05	Ø1.4 mm	3800123165405
110910 for RD-SG05	Ø1.8 mm	3800123173059
110911 for RD-SG05	Ø2.0 mm	3800123173066
110913 for RD-SG07	Ø2.0 mm	3800123173677



## CUP FOR RD-SG05

[BG] Казанче за бояджийски пистолет RD-SG05 • [RO] Rezervor pentru pistol de vopsit • [SR] Plastično lonče za pištolj za farbanje • [MK] Пластичен сад за спреј пиштол • [RU] Бак нейлоновый для краскопульта • [SL] Dozirni lonček • [EL] Άνω δοχείο PVC πιστολιών βαφής • [HR] Plastično lonče za pištolj za boju • [FR] Atelier de peinture pour la peinture au pistolet • [IT] Negozio di vernici per verniciatura a pistola • [ES] Paint-vendejo por pafotrapo • [PT] Loja de pintura para pintura de armas

art. №	ml (capacity)	BARCODE
110912 for RD-SG05	600	3800123173073



## SILICONE CARBIDE SAND FOR SANDBLASTING

[BG] Пляськ абразивен за пясъкоструен пистолет • [RO] Nisip carbură de siliciu • [SR] Abrazivni pesok • [MK] Песок абразивен • [RU] Порошок абразивный • [SL] Vakrova žindra • [EL] Λειαντικός άμμος • [HR] Brusni pijesak • [FR] Sable abrasif pour un pistolet de sablage • [IT] Sabbia abrasiva per una pistola di sabbatura • [ES] Abrasiva sablo por sandblast pafilo • [PT] Areia abrasiva para uma pistola de jato de areia

art. №	kg	BARCODE
160151	1	3800123166655



## HEPA FILTER

[BG] HEPA филтър • [RO] Filtru HEPA • [SR] HEPA filter • [MK] HEPA филтер • [RU] HEPA фильтр • [SL] HEPA filter • [EL] Φίλτρο HEPA • [HR] HEPA filtar • [FR] Filtre HEPA • [IT] Filtro HEPA • [ES] HEPA-filtro • [PT] Filtro HEPA

### HEPA FILTER FOR METAL ASH CLEANER

art. №	L (capacity)	BARCODE
090307 for metal container	18	3800972003316



### HEPA FILTER FOR VACUUM CLEANER

art. №	L (mm)	Ø mm	BARCODE
090302 for RD-WC01	116	122	3800123167843
090305 for RD-WC02	108	123	3800123173684
090309 for RD-WC03	120	100	3800972008830
090311 for RD-WC04	107	137	3800972012639





## ENGINE OIL SAE30 1L

[BG] Масло SAE30 1L • [RO] Ulei de motor SAE 30 1L • [SR] Motorno ulje SAE 30 1L • [MK] Моторно масло SAE 30 1L • [RU] Моторное масло SAE 30 1л • [SL] Motorno olje SAE 30 1L • [EL] Λάδι κινητήρα SAE 30 1L • [HR] Motorno ulje SAE 30 1L • [FR] Huile moteur SAE 30 1L • [IT] Olio motore SAE 30 1L • [ES] Engine Oil SAE 30 1L • [PT] Óleo de Motor SAE 30 1L

Art. No. 075906

EAN: 3800972005105

Art. No. 075903

EAN: 3800123172076



**Two Stroke Oil 2T MIX**  
Масло за двуктактови  
двигатели 2T MIX  
1000 ml

## TWO STROKE SEMI SYNTHETIC LOW STROKE OIL 1L

[BG] Масло за двуктактови двигатели полусинтетично бездимно • [RO] Ulei de transmisie • [SR] Prenosno ulje • [MK] Преносно масло • [RU] Трансмисионное масло • [SL] Prenosno olje • [EL] Λάδι κιβωτίου ταχυτήτων • [HR] Ulje mjenjača • [FR] Huile de transmission • [IT] Olio cambio • [ES] Transdono petrolo • [PT] Óleo de Transmissão

Art. No. 075905

EAN: 3800972002487



## BLOW TORCH

[BG] Горелка със спусък • [RO] Arzator • [SR] Gasni brener • [MK] Горилник со активирање • [RU] Газовая горелка • [SL] Plinski gorilnik • [EL] Καμινέτο υγραερίου • [HR] Plamenik Plinski • [FR] Brûleur • [IT] Bruciatore a gas • [ES] Burner • [PT] Queimadoro

art. №	Ø (mm)	L1 (mm)	BARCODE
491512 for RD-GHT01	40	30	3800123118722
491513 for RD-GHT02	50	40	3800123118739
491514 for RD-GHT03	60	40	3800123118746

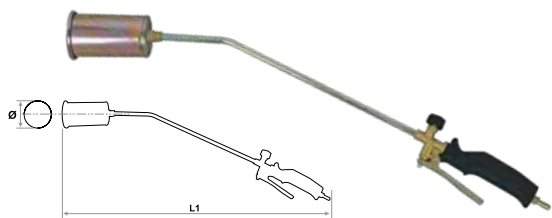

## GEAR OIL EP90 1L

[BG] Масло трансмисионно EP90 1L • [RO] Ulei de transmisie EP 90 1L • [SR] Prenosno ulje EP 90 1L • [MK] Преносно масло EP 90 1L • [RU] Трансмисионное масло EP 90 1L • [SL] Prenosno olje EP 90 1L • [EL] Λάδι κιβωτίου ταχυτήτων EP 90 1L • [HR] Ulje mjenjača EP 90 1L • [FR] Huile de transmission EP 90 1L • [IT] Olio cambio EP 90 1L • [ES] Transdono petrolo EP 90 1L • [PT] Óleo de Transmissão EP 90 1L

Art. No. 075902

EAN: 3800123172069



## BLOW TORCH FOR CARTRIDGE PIEZO

[BG] Горелка за патрон с пиезо • [RO] Lampă de gaz cu arzător • [SR] Gasni brener • [MK] Горилник со тенк • [RU] Газовая горелка • [SL] Plinski gorilnik • [EL] Καμινέτο υγραερίου • [HR] Plamenik Plinski • [FR] Brûleur à gaz • [IT] Bruciatore a gas • [ES] Gasfumilo • [PT] Queimador a gás

Art. No. 450101

EAN: 3800123164606



## MOBILE SYSTEM WHEEL BASE

[BG] Основа на колела за мобилна система • [RO] Baza roti sistem mobil • [SR] Kolica za ladice • [MK] Носач на мобилен систем • [RU] Тележка для пластмассового ящика • [SL] Kovaček za orodje plastični • [EL] Πλατφόρμα εμπορευμάτων τροχήλατη • [HR] Kolica za ladice • [FR] Chariot pour boîte en plastique • [IT] Carrello per scatola di plastica • [ES] Carro para caja de plástico • [PT] Carrinho para caixa de plástico

art. №	Size cm	BARCODE
139612	46.5x33x11	3800972012370



## PLASTIC CASE FOR MOBILE SYSTEM WITH ORGANAISER

[BG] Пластмасов куфар за инструменти с организер • [RO] Cutie pentru scule • [SR] Kutija za alat plasticon • [MK] Кутия за алат од пластика • [RU] Ящик для инструментов • [SL] Kovaček za orodje plastični • [EL] Εργαλειοθήκη κουτία πλαστική • [HR] Kutija za alat plasticon • [FR] Servante mobile en plastique • [IT] Scatola degli attrezzi di plastica • [ES] Caja de herramientas modular plastica • [PT] Caixa de ferramentas plastica

art. №	Size cm	capacity kg	BARCODE
139610	44x32x15	15	3800972012356



## PLASTIC CASE FOR MOBILE SYSTEM

[BG] Пластмасов куфар за инструменти • [RO] Cutie pentru scule • [SR] Kutija za alat plasticon • [MK] Кутия за алат од пластика • [RU] Ящик для инструментов • [SL] Kovaček za orodje plastični • [EL] Εργαλειοθήκη κουτία πλαστική • [HR] Kutija za alat plasticon • [FR] Servante mobile en plastique • [IT] Scatola degli attrezzi di plastica • [ES] Caja de herramientas modular plastica • [PT] Caixa de ferramentas plastica



































art. №	Size cm	capacity kg	BARCODE
139611	44x32x25.5	18	3800972012363









































## Meaning of Pictograms / Описание на Пиктограмите

 <p><b>230V~50Hz</b></p>	<p>Power supply • Захранване • Tensione in trare • Napajanje • Напон • Источник питания • Napetost • Τροφοδοσία • Napajanje • Source de courant • Alimentazione elettrica • Fonte de nutrado • Fonte de energia</p>	 <p><b>1500 mAh</b></p>	<p>Device is equipped with laser indicator • Машината е снабдена с лазерен индикатор • Echipat cu indicator laser • Машина poseduje laserski indikator • Уредот е опремен со ласерски индикатор • Устройството осначено индикатором лазерный • Všebeje laser • Η συσκευή είναι εξοπλισμένη με δείκτη λέιζερ • Laser • L'appareil est équipé d'un indicateur laser • Il dispositivo è dotato di indicatore laser • Aparato estas ekipita per lasera indikilo • O dispositivo está equipado com indicador de laser</p>
 <p><b>950W</b></p>	<p>Power • Мощност • Putere • Snaga • Моќност • Питание • Моќ • Εξουσία • Snaga • Puissance • Energia • Potenco • Poder</p>	 <p><b>LCD DISPLAY</b></p>	 <p><b>DUST CAPTURE ПРАХО - УЛАВЊАЊЕ</b></p>
 <p><b>0-1000 min<sup>-1</sup></b></p>	<p>Maximum rotations • Обороти • Nr. maxim rotatii • Maksimalni broj obrtaja • Максимални вртежи • Максималниот вртежи • Število vrtajev • Μέγιστος περιστροφές • Revolucije • Rotations maximales • Rotazioni massime • Maksimumaj rotacioj • Rotações máximas</p>	 <p><b>0.58 m</b></p>	 <p><b>45°</b></p>
 <p><b>3.5 kg</b></p>	<p>Weight • Тегно • Greutate • Težina • Тежина • Масса • Teža • Βάρος • Težina • Poids • Il peso • Peso • Carga</p>	 <p><b>13mm</b></p>	 <p><b>Ø [mm] 185x20x18T</b></p>
 <p><b>VARIABLE SPEED</b></p>	<p>Variable speed • Регулируеми обороти • Viteza variabila • Podešavanje broja obrtaja • Варијација на вртежи • Регулируема скорост • Nastavljiva hitrost • Ρυθμιζόμενη ταχύτητα • Podestis brzine • Vitesse variable • Velocità variabile • Varia rapido</p>	 <p><b>26mm</b></p>	 <p><b>63 mm (max)</b></p>
 <p><b>L R</b></p>	<p>Left - right rotations • Реверс • Rotatie stanga-dreapta • Rotacija u oba smjera • Реверс • Реверс • Leva – desna rotacija • Αντίστροφοι • Revertza Rotations gauche - droite • Rotazioni sinistra-destra • Maldekstre-dekstraj rotacioj • Rotações esquerda-direita</p>	 <p><b>30mm</b></p>	 <p><b>0-3 mm</b></p>
 <p><b>1-16mm</b></p>	<p>Chuck diameter • Размер патронник • Diametru interior mandrina • Dimenzije glave bušilice • Дијаметар на футер • Диаметр патрона • Velikost glave • Τροφοδοσία • Stezna glava veličina • Diamètre du mandrin • Diametro del mandrino • Chuck-diametro • Diâmetro do mandril</p>	 <p><b>2.8J</b></p>	 <p><b>82 mm</b></p>
	<p>Impact function • Ударна функција • Functie impact • Udamna funkcija • Ударна функција • Импакт функција • Udamna funkcija • Λειτουργία των επιπτώσεων • Udarce funkcija • Fonction d'impact • Funzione d'impatto • Trafo funkcio • Função de impacto</p>	 <p><b>2650 min<sup>-1</sup></b></p>	 <p><b>8 mm</b></p>
	<p>Keyless chuck • Брзозатезајач патронник • Mandrina rapida • Brzozatazajaci dodatak • Брзо затегнувачки футер • Быстрозахватный патрон • Hitrovenjalna vrtalna glava • Ταχύτοκ • Brzostezna glava • Mandrin sans clé • Mandrino senza chiave • Chuck sen šlosilo • Chuck sem chave</p>	 <p><b>LOCK</b></p>	 <p><b>0-40 mm</b></p>
 <p><b>COLOR BOX</b></p>	<p>Wrap in color box • Опаковано в цветна кутија • Ambalaj colorat • Uprakovano u kutiji u boji • Спакувано во кутија • Обверните в коробке цвета • Zavijte ga v polju barva • Туλιците се кути хрмијотот • Pakiranje u kutiji u boji • Envelopper dans la boîte de couleur • Avvolgi nella scatola dei colori • Envolvijo en kolora skatolo • Embrulhar em caixa de cor</p>	 <p><b>125 mm</b></p>	 <p><b>120-380 m/min</b></p>
	<p>Case packing • Куфар • Cutie • Uprakovano u koferu • Куфер • Чемадан • Zadeva pakiranje • Υπόβση Συσκευασία • U kofer • Emballage de cas • Imballaggio della cassa • Skatola pakado • Embalagem da caixa</p>	 <p><b>22.2 mm</b></p>	 <p><b>76x533 mm</b></p>
 <p><b>2x GEARS</b></p>	<p>Gears • Скорости • Pinioane • Zupčanici • Запчаници • Передачи • Zobniki • Γρανάζια • Brzine • Engrenages • Ingranaggi • Ilaro • Engrenagem</p>	 <p><b>0.58 m</b></p>	 <p><b>0.58 m</b></p>

## Meaning of Pictograms / Описание на Пиктограмите











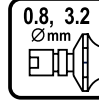

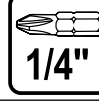







 <p><b>CHARGING TIME 1h</b></p>	<p>Charging time • Време за зареждане на батерията • Timp de încărcare a bateriei • Vreme punjenja baterije • Време на пълнене на батерията • Време заряди акумулатора • Čas polnjenja baterije • Ο χρόνος φόρτισης της μπαταρίας • Vrijeme punjenja baterija • Temps de charge • Tempo di carica • Tempo de sarço • O tempo de carga</p>	 <p><b>115 mm</b></p>	<p>Cutting depth in wood • Дълбочина на рязане в дърво • Adancime taiere in lemn • Dubina sečenja kroz drvo • Длабочина на сечене во дрво • Глубина пропила в дресевине • Globina reza • Βάθος κοπής σε ξύλο • Dubina rezanja u drvu • Profondeur de coupe dans le bois • Profondità di taglio in legno • Trança profundo em ligno • Profundidade de corte em madeira</p>	 <p><b>Ø120/140 mm</b></p>	<p>Mixing paddle diameter • Диаметър на бъркалката • Diametru paleta mixare • Prečnik mešalice • Диаметар на мешаклата • Диаметр смешивание веслом • Mešanje veslo premera • Αντίχειρ διάμετρο κοπτή • Promjer miješalcom • Diamètre de la palette de mélange • Diametro della palette di miscelazione • Miksante diametron • Diâmetro da pá de mistura</p>
 <p><b>18 V</b></p>	<p>Voltage • Волтаж • Voltaj • Voltaža • Напон • Напряжение • Napetost • Δυναμικό • Napon • L'voltage • Voltaggio • Tensio • Voltagem</p>	 <p><b>90 mm</b></p>	<p>Max cutting depth in metal • Макс. дълбочина на рязане в метал • Adancime maxima de taiere in metal • Maksimalna dubina sečenja kroz metal • Максимальна длабочина на сечене во метал • Максимальная глубина резания металлов • Največja globina reza v kovino • Μέγιστο βάθος κοπής μετάλλων • Maks. dubina rezanja u metalu • Profondeur de coupe max en métal • Massima profondità di taglio in metallo • Maksimuma trança profundo em metalo • Profundidade máxima de corte em metal</p>	 <p><b>0.30 L/min</b></p>	<p>Maximum capacity • Максимален капацитет • Capacitate maxima • Maksimalni kapacitet • Максимальный капацитет • Максимальная мощность • Največji pretok • Η μέγιστη χωρητικότητα • Maksimalni kapacitet • Capacité maximale • Capacità massima • Maksimuma kapacito • Capacidade máxima</p>
 <p><b>42 Nm</b></p>	<p>Torque • Въртящ момент • Cuplu maxim • Obrtni momenat • Вртежен момент • Крутящий момент • Моџ в Nm • Potņi • Zakretnog momenta • Couple • Momento torcente • Paro • Esforço de torção</p>	 <p><b>90 mm</b></p>	<p>Max cutting depth in PE / PP • Макс дълбочина на рязане в PE / PP • Adancime maxima de taiere in PE / PP • Maks. dubina sečenja kroz PE / PP • Максимальна длабочина на сечене во PE / PP • Максимальная глубина резания PE / PP • Največja globina reza v PE / PP • Μέγιστο βάθος κοπής PE / PP • Maks. dubina rezanja u PE / PP • Profondeur de coupe max en PE / PP • Profondità di taglio massima in PE / PP • Maksimuma trança profundo em PE / PP • Profundidade máxima de corte em PE / PP</p>	 <p><b>800ml</b></p>	<p>Container capacity • Обем на контейнера • Capacitate recipient • Kapacitet kontejnera • Капацитет на контейнерот • Объем контейнера • Frostotinja posode • Όγκος δοχείου • Volumen spremnika • Capacité du conteneur • Capacità del contenitore • Kapabilo • Capacidade do recipiente</p>
 <p><b>16 + 1</b></p>	<p>Torque control range • Степени на регулиране на въртящия момент • Control putere-cuplu • Stepan regulacije unutrašnjeg momenta • Степен на регулация на вртежниот момент • Диапазон управления моментом • Navoga območje • Potņi ējros ēlēģu • Stupanj kontrole momenta • Plage de contrôle de couple • Campo di controllo della coppia • Paro kontrolo gamo • Faixa de controle de torque</p>	 <p><b>24 mm</b></p>	<p>Move of the knife • Ход на ножа • Accident vascular cerebral lama • Нод ножа • Потег на мечот • Ход лезвия • Нод rezila • Εγκερφαλικό ή λαιβό • Pomiscanje noz • Mouvement du couteau • Spostamento del coltello • Movó de la tranção • Mover da faca</p>	 <p><b>Ø0.8mm</b></p>	<p>Paint nozzle diameter • Диаметър на дюзата за боя • Diametru duza • Prečnik mlaznice za boju • Диаметар на дюзната • Диаметер сопла для краски • Premer šobe za barve • Διαμέτρος πύκνου ή βαφής • Promjer mlaznice boja • Diamètre de la buse de peinture • Dipingi il diametro dell'ugello • Pentras cigaredon diametro • Diâmetro do bico de pintura</p>
 <p><b>Ø125mm</b></p>	<p>Diameter of abrasive disc • Диаметър на шлифовъчния диск • Diametru disc abraziv • Prečnik diska za šljafovanje • Диаметар на абразивниот диск • Диаметер шлифовального диска • Premer brusilnega diska • Διαμέτρος δίσκου τυπ λειαντικού • Promjer brusa • Diamètre du disque abrasif • Diametro del disco abrasivo • Diametro de abrasia disko • Diâmetro do disco abrasivo</p>	 <p><b>12.7mm</b> <b>150mm</b> <b>20mm</b></p>	<p>Disc dimensions • Размери на диска • Dimensiuni disc • Dimenzije diska • Размер на диск • Диск размери • Velikosti diska • Διαστάσεις δίσκου • Veličina diska • Dimensions du disque • Dimensioni del disco • Dimensiaj diskaj • Dimensões do disco</p>	 <p><b>115mm</b> <b>220mm</b></p>	<p>Base dimensions of finishing sander • Размери на шурката • Dimensiunile bazei de slefuire • Dimenzije šmirgle • Диаметар на базата на шнајферката • Базовые размеры отделочных шлифовальный • Osnovna dimenzija brusnega rariča • Διαστάσεις βάσης της τριβείας πινελιού • Veličina brusnih papirnih Dimenzions de base de la ponceuse de finition • Dimensioni di base della levigatrice di finitura • Bazo-dimensioj de finado de polvo • Dimensões de base da lixadeira de acabamento</p>
 <p><b>230V~ 50Hz</b></p>	<p>Power supply • Захранване • Tensiune intrare • Napajanje • Напон • Источник питания • Napetost • Трофопобига • Napajanje • Source de courant • Alimentazione elettrica • Fonte de nutrado • Fonte de energia</p>	 <p><b>10 MPa</b></p>	<p>Maximum pressure • Максимално налягане • Presiune maxima • Maksimalni pritisk • Максимален притисок • Максимальное давление • Maksimalni pritisk • Μέγιστη πίεση • Maksimalni pritisk • Pression maximale • Pressione massima • Maksimuma premo • Pressão máxima</p>	 <p><b>0-45°</b></p>	<p>Cutting angle adjustment • Рязане под ъгъл • Ajustare unghi taiere • Sečenjenje pod uglom • Сечене под агол • Регулировка угла резания • Nastavljiv kot rezanja • Κοπή πύκνου γωνίας • Kut rezanja • Réglage de l'angle de coupe • Regolazione dell'angolo di taglio • Angleustiga angulo • Ajuste do ângulo de corte</p>
 <p><b>760 W</b></p>	<p>Power • Мощност • Putere • Snaga • Мојност • Питание • Моџ • Εξουσία • Snaga • Puissance • Energia • Potenco • Poder</p>	 <p><b>M12-M24</b></p>	<p>Bolt thread dimensions • Размер на резбата на болта • Dimensiunea de fire suruburi • Veličina šrafovске niti • Големина на завонте на зарвката • Размер резьбы болтов • Velikost vijakov niti • Μέγεθος στειρωμα της βίβος • Iznos vijak niti • Dimensions du filetage du boulon • Dimensioni della filettatura del bullone • Dimensio de riglio • Dimensões da rosca</p>	 <p><b>Ø [mm]</b> <b>210x30mm</b> <b>24T</b></p>	<p>Circular disc dimensions • Размери на диска за циркулар • Dimensiuni disc • Dimenzije diska • Размер на дискот • Диск размери • Velikosti diska • Διαστάσεις δίσκου • Veličina kružnom disku • Dimensions du disque circulaire • Planifier la largeur maximale • Pianificazione della Dimensiones du disque circulaire • Cirkulaj diskodimensioj.. • Dimensões do disco circular.</p>
 <p><b>0-2600 min<sup>-1</sup></b></p>	<p>Maximum rotations • Обороти • Nr. maxim rotatii • Maksimalni broj obrtaja • Максимални вртежи • Максимальный вращения • Številni vrtjajev • Μέγιστες περιστροφές • Revolucije • Rotations maximale • Rotazioni massime • Maksimumaj rotacijo • Rotações máximas</p>	 <p><b>115 mm</b></p>	<p>Maximum diameter of grinding disc • Макс. диаметър на шлифовъчния диск • Diametru maxim disc slefuire • Maksimalni prečnik diska za šljafovanje • Макс. диаметар на дискот за брусьене • Максимальный диаметр шлифовального диска • Največji premer brusilnega diska • Μέγιστο διάμετρο δίσκου λειαντικού • Max. Promjer brusa • Diamètre maximum du disque de meulage • Diametro massimo del disco di levigatura • Maksimuma diametro de muelanta disko • Diâmetro máximo do disco de moagem</p>	 <p><b>0-3 mm</b></p>	<p>Planning depth • Дълбочина на рендосване • Adancime maxima prelucrare • Dubina renđanja • Длабочина на стругање • Глубина строгания • Nastavljiva globina utora • Βάθος πλάνισης • Dubina planiranje • Profondeur de planification • Profondità di pianificazione • Planado de profundo • Profundidade de planeamento</p>
 <p><b>2 kg</b></p>	<p>Weight • Терно • Greutate • Težina • Тежина • Масса • Teža • Βάρος • Težina • Poids • Il peso • Peso • Carga</p>	 <p><b>22.2 mm</b></p>	<p>Inner diameter of the disc • Втрешен диаметър на диска • Diametru interior disc • Unutrašnji prečnik diska • Напон • Внутренний диаметр дисков • Внатрешен дијаметар на дискот • Εσωτερική διάμετρος του δίσκου • Unutarnji promjer diska • Diamètre intérieur du disque • Diametro interno del disco • Interna diametro de la disko • Diâmetro interno do disco</p>	 <p><b>82 mm</b></p>	<p>Planning maximum width • Макс. ширина на рендосване • Latime maxima prelucrare • Maksimalna širina renđanja • Макс. ширина на стругање • Ширина строгания • Nastavljiva širina • Πλάτος πλάνισης • Širina planjanja • Planifier la largeur maximale • Pianificazione della larghezza massima • Planante maksimumam larçon • Largura máxima de planeamento</p>
	<p>Variable speed • Регулируеми обороти • Viteza variabila • Podešavanje broja obrtaja • Варијација на вртежи • Регулируемая скорость • Nastavljiva hitrost • Ρυθμιζόμενη ταχύτητα • Podsvi brzine • Vitesse variable • Velocità variabile • Varia rapido</p>		<p>Spindle lock • Блокровка на вала • Buton blocare ax • Блокатор talasa • Блокада на вртало • Блокровка шпинделя • Snemalni gumb • Το κλειδίμα του άξονα • Zaključavanje osovine • Blocage de la broche • Blocco del mandrino • Spinita seruro • Bloqueio do eixo</p>	 <p><b>0-12.5mm</b></p>	<p>Plunge depth • Ход на фрезоващата глава • Afundare maxima • Ujaz za glavu frezera • Од на главата на фрезата • Окуניתесь глубины • Stroke rezalna glava • Βάθος βουτιά • Potezom mljevenja glave • Profondeur de plongée • Profundità di immersione • Profundígu • Profundidade de mergulho</p>
	<p>Left-right rotations • Реверс • Rotatie stanga-dreapta • Rotacija u oba smera • Реверс • Реверс • Leva – desna rotacija • Αντίστροφ • Reversna Rotations gauche - droite • Rotazioni sinistra-destra • Maldekstre-dekstraj rotacioj • Rotações esquerda-direita</p>	 <p><b>Ø max 13 mm</b></p>	<p>Maximum diameter of equipment • Максимален диаметър • Diametru maxim accesorii • Maksimalni prečnik • Максимален дијаметар на опремата • Максимальный диаметр оборудование • Maksimalni premer općija • Μέγιστη διάμετρος του εξοπλισμού • Maksimalni promjer • Diamètre maximum de l'équipement • Diametro massimo dell'attrezzatura • Maksimuma diametro de ekipajo • Diâmetro máximo do equipamento</p>	 <p><b>0-200 °C</b></p>	<p>Temperature range • Температурен обхват • Interval temperatura • Temperaturni opseg • Опек на температура • Диапазон температура • Обмоте temperature • Εύρος θερμοκρασίας • Temperaturno područje • Ecart de température • Intervallo di temperatura • Temperaturo • Faixa de temperatura</p>
 <p><b>1.5-13 mm</b></p>	<p>Chuck diameter • Размер патронник • Diametru interior mandrina • Dimenzije glave bušilice • Диаметар на футер • Диаметер патрона • Velikost glave • Трофодиско • Stezna glava veličina • Diamètre du mandrin • Diametro del mandrino • Chuck-diametro • Diâmetro do mandril</p>	 <p><b>1200 mAh</b> <b>Li-Ion</b></p>	<p>Battery type and capacity • Тип батерия и капацитет • Tip si capacitate baterie • Тип батерје и капацитет • Тип на батерия и капацитет • Аккумулятор и мощность • Моџ батерје • Τύπος μπαταρίας και ικανότητα • Vrsta baterije i kapacitet • Type de batterie et capacité • Tipo di batteria e capacità • Tipo de baterio kaj kapacito • Tipo de bateria e capacidade</p>	<p><b>LCD DISPLAY</b></p>	<p>LCD Display • LCD Экран • Display LCD • LCD Ekran • LCD Экран • LCD дисплей • LCD Display • Οθόνιν LCD • LCD zaslon • Afichage LCD Display • Ekran LCD • Ekran LCD</p>

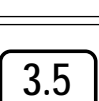
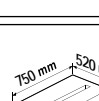

## Meaning of Pictograms / Описание на Пиктограмите

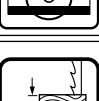
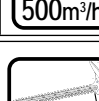
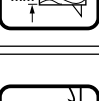















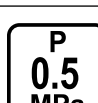
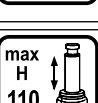



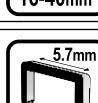





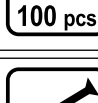

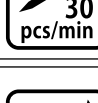

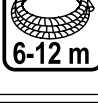
	<p>Impact function • Ударна функција • Functie impact • Udarna funkcija • Ударна функција • Импакт функција • Udarne funkcija • Λειτουργία των επιπτώσεων • Udarce funkcio • Functio d'impact • Funzione d'impatto • Trato funkcio • Função de impacto</p>		<p>Max. drilling diameter in metal • Макс. диамeтър на пробиване в метал • Diametru maxim gaurire metal • Maks. prečnik probijanja kroz metal • Макс. диамeтър на дупчење во метал • Макс. диамeтър сверления в металле • Maks. premer vrtanja v kovino • Μέγιστη διάμετρος τρυπήματος σε μέταλλο • Maks. promjer bušenja u metalu • Max. diamètre de perçage en métal • Max. diametro di foratura in metallo • Maks. boranta diametro en metalo • Max. diâmetro de perfuração em metal</p>		<p>Device is equipped with bulb or LED • Машината е снабдена с LED диод • Echipat cu bec sau LED • Mašina poseduje LED sijalicu • Уредот е опремен со LED Свјатилца • Устройството осначено лампы или светодиоди • Vsebuje žarnico ali LED žarnico • Η συσκευή είναι εξοπλισμένη με λάμπα ή LED • Stroj sa LED diodom L'appareil est équipé d'une ampoule ou d'une LED • Il dispositivo è dotato di lampadina o LED • Aparato estas ekipita per ampolo aŭ LED • Il dispositivo è dotato di lampadina o LED • O dispositivo está equipado com lâmpada ou LED</p>
	<p>Chuck thread • Резба на патронника • Mandrina tip • Navoj glave bušilice • Объем на вратилото • Тема Чака • Chuck temo • Тоак θεμά • Stezna glava provucite • Fil de mandrin • Fila di Chuck • Chuck-fadeno • Rosca de mandril</p>			<p>Working temperature • Работна температура • Temperatura de lucru • Radna temperatura • Работна температура • Рабочая температура • Temperatura • Θερμοκρασία λειτουργίας • Radna temperatura • Temperature de fonctionnement • Temperatura di lavoro • Laboranta temperaturo • Temperatura de trabalho</p>	
	<p>Chuck diameter • Размер патронник • Diametru interior mandrina • Dimenzije glave bušilice • Диамeтър на футер • Диамeтър патрона • Velikost glave • Трофоборџио • Velicina stezna glava • Diamètre du mandrin • Diametro del mandrino • Chuck-diametro • Diâmetro do mandril</p>			<p>Flow capacity • Дебит на въздуха • Capacitate de evacuare • Capacitet struje • Капацитет на струјата • Производителност потока • Pretočnost • Ικανότητα ροής • Protok zraka • Capacité de débit • Portata • Flua kapacito • Capacidade de fluxo</p>	
	<p>Maximum height • Максимална височина • Inaltime maxima • Maksimalna visina • Максимална висина • Максимална висота • Maksimalna visina • Μέγιστο ύψος • Maksimalna visina • Hauteur maximale • Altezza massima • Maksimuma alteco • Altura máxima</p>			<p>Working temperature • Работна температура • Temperatura de lucru • Radna temperatura • Работна температура • Рабочая температура • Temperatura • Θερμοκρασία λειτουργίας • Radna temperatura • Temperature de fonctionnement • Temperatura di lavoro • Laboranta temperaturo • Laboranta temperaturo • Temperatura de trabalho</p>	
	<p>Diameter of abrasive disc • Диамeтър на шлифовъчния диск • Diametru disc abraziv • Prečnik diska za šljajfovanje • Диамeтър на абразивниот диск • Диамeтър шлифовалногo диска • Premer brusilnega diska • Διάμετρος δίσκου των λειαντικών • Promjer brusa • Diamètre du disque abrasif • Diametro del disco abrasivo • Diametro de abrasia disko • Diâmetro do disco abrasivo</p>			<p>Blade length • Дължина на режештата лента • Lungime lama • Dužina trake za sečenje • Должина на сечило • Дължина клина • Dolžina rezanja traku • Μέκος λαιός • Duljina rezanja trake • Longueur de la lame • Lunghezza della lama • Klingo longeco • Comprimento da lâmina</p>	
	<p>Base dimensions of finishing sander • Размери на шкурката • Dimensiunile bazei de slefuire • Dimenzije šmirgle • Диамeтър на базата на шлајферката • Базовые размеры отделочных шлифовальный • Основна dimenzija brusnega papirja • Διαστάσεις βάσης της τριβείο φινιρίσματος • Velicina brusnim papirjom • Dimensions de base de la ponceuse de finition • Dimensioni di base della levigatrice di finitura • Dimensioni di base della levigatrice di finitura • Bazo-dimensioj de finado de polvo • Dimensões de base da lixadeira de acabamento</p>			<p>Teeth per inch • Брой зъби на инч • Dinti per 1 Inch • Број зуби по инч • Брой на зъби на инч • Зуби на дюйм • Številu zob na palec • Δόντια ανά ίντσα • Број зуби по инчу • Dents par pouce • Dentí per pollice • Dentoj po colo • Dentes por polegada</p>	
	<p>Belt transport speed • Скорост на лентата • Viteza curea transmisie • Brzina trake • Издржливиост на ремeнот • Скорост протягивания ленти • Hitrost krožnega brusilca • Ταχύτητα ταινίας • Brzina trake • Courroie de transport • Velocità di trasporto della cinghia • Rapido de transporte de zona • Velocidade de transporte da correia</p>			<p>Pendulum movement position • Позиции на махаповидното движение • Pozitie reglabila • Pozicije klatnastog rotmeranja • Позиција на поклањаче • Положение маятника движение • Nihajnega pretok položaja • Εκκρεμές θέση κίνησης • Položaj kretanja klatna • Pendolo movo pozicio • Posizione del movimento del pendolo • Pendolo movo pozicio • Posição do movimento pendular</p>	
	<p>Belt dimensions • Размери на шкурката за лентов шлайф • Dimensiuni curea transmisie • Dimenzija šmirgle za trakasto šljajfovanje • Големина на шмирплата • Размери ленти • Dimenzija brusnega traku • Ζώνη διαστάσεις • Velicina papirjom za Trakna brusilica • Dimensions de la ceinture • Dimensioni della cinghia • Zonaj • Dimensões da correia</p>			<p>Blade size • Размер на ножа • Marime lama • Dimenzije noža • Големина на ножот • Размер лезвия • Velikost rezila • Μέκος λαιός • Velicina nožem • Taille de la lame • Dimensione della lama • Klingo grandeco • Tamanhão da lâmina</p>	
	<p>SDS Plus chuck • Патронник SDS+ • Mandrina SDS Plus • Burgija SDS Plus • Футер SDS Plus • SDS plus Чак • Vpetje SDS+ • Тоак SDS+ • Stezna glava SDS+ • Mandrin SDS Plus • SDS+ chuck • Chuck SDS+ • Mandril SDS Plus</p>			<p>Maximum width of the workpiece • Максимална ширина на обработаниот детал • Dimensiune maxima de prelucrat • Maksimalna širina obradivog predmeta • Максимална широчина на работното парче • Максимална ширина заготовки • Največja širina obdelovanca • Μέγιστο πλάτος του τεμαχίου • Maksimalna širina komada • Largeur maximale de la pièce • Larghezza massima del pezzo • Maksimuma laržo de la peco • Largura máxima da peça de trabalho</p>	
	<p>Scope of moment • Въртящ момент • Cuplu maxim • Obrtni momenat • Вртежен момент • Крутящий момент • Моќ в Nm • Ροπή • Zakretnog momenta • Couple • Momento torcente • Paro • Esforço de torção</p>			<p>Cutting angle adjustment • Рязане под ъгъл • Ajustare unghi taiere • Sečenje pod uglom • Сеченье под арон • Регулировка угла резания • Nastavljiv kot rezanja • Κοπή ρυθμίτη γωνίας • Kut rezanja • Réglage de l'angle de coupe • Regolazione dell'angolo di taglio • Anglueistiga angulo • Ajuste do ângulo de corte</p>	
	<p>Sockets dimensions • Размер вложки • Dimensiuni adaptor • Dimenzije utičnice • Диамeтър на продолжетокот • Сокектами размери • Utičnice dimenzije • Πρίζες διαστάσεις • Velicina uteci • Dimensions des douilles • Dimensiuni prese • Kovrondimensioj • Dimensões dos soquetes</p>			<p>Max load • Максимален товар • Încărcătură maximă • Maksimalno opterećenje • Максимален товар • Максимална нарузка • Največja obremenitev • Μέγιστο φορτίο • Maksimalni opterećenje • Charge maximale • Carico massimo • Maksimuma šaržo • Carregamento máximo</p>	

## Meaning of Pictograms / Описание на Пиктограмите

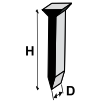









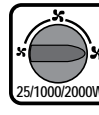
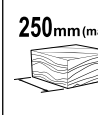



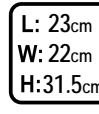
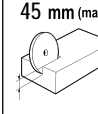













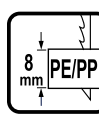
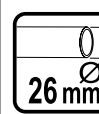

 <p><b>2.8 cfm</b> <b>79.2L/min</b></p>	<p>Avg. Air Consumption • Консумация на въздух • Consum aer/Putere absorbtie aer • Konzumacija vazduha • Консумация на въздух • Потребление воздуха • Poraba zraka • Κατανάλωση Αέρα • Потрошња zraka • Consommation d'air • Consumo d'aria • Aera konsumo • Consumo de ar</p>	 <p><b>0.8, 3.2</b> <b>Ø mm</b></p>	<p>Diameter collet • Диаметр на цангата • Diametru mandrina freza electrica • Prečnik stezne čaure • Диаметр на футер • Цанговий диаметр • Premer stročnic • Διάμετρος τοοκ • Promjer stezne čahure • Diamètre des manchons • Diametro delle maniche delle pinze • Pinča manjkoj diametro • Diâmetro de mangas</p>
 <p><b>52 cm</b></p>	<p>Log length • Дължина на дървото • Lungime bustean • Dužina drveta • Должина на дрвото • Дължина дървета • Dolžina drevesa • Μήκος του δέντρου • Duljina stabla • Longueur du journal • Lunghezza del registro • Log longa • Comprimento do log</p>	 <p><b>600ml</b></p>	<p>Container capacity • Объем на контейнера • Capacitate recipient • Kapacitet kontejnera • Капацитет на контейнерот • Объем контейнера • Prostornina posode • Όγκος βουξίου • Volumen spremnika • Capacité du conteneur • Capacità del contenitore • Kapabilo • Capacidade do recipiente</p>
 <p><b>50-250cm</b></p>	<p>Log diameter • Диаметър на дървото • Diametru bustean • Prečnik drveta • Диаметр на дрвото • Диаметр дървета • Premer drevesa • Διάμετρος του δένδρου • Promjer stabla • Diamètre de la bûche • Diametro del registro • Diametro de stipo • Diâmetro do log</p>	 <p><b>80L</b></p>	<p>Dust bag capacity • Объем на торбата за прах • Capacitate sac colector • Zapremina torbe za prašinu • Капацитет на торба за прашина • Емкост мешка для сбора пыли • Prostornina vrečke za prah • Χωρητικότητα σακούλας • Objam vrećice za prašinu • Capacité du sac à poussière • Capacità del sacchetto di polvere • Kapabla saketo • Capacidade do saco de poeira</p>
 <p><b>7500min<sup>-1</sup></b></p>	<p>Blade revolutions per minute • Обороти на ножа • Rotatii pe minut • Lama • Obrtaji noža • Вртежи на ножот во минута • Клинок оборотов в минуту • Brzina nožem • Tours de lame par minute • Rotazioni della lama al minuto • Klingo-revolucioj je minuto • Rotações da lâmina por minuto</p>	 <p><b>102mm</b></p>	<p>Connector diameter • Диаметър на конектора • Diametru conector • Prečnik konektora • Диаметр на конекторот • Конектор диаметра • Priključek premera • Διαμέτρος σύνδεσης • Promjer priključka • Diametro de konektio • Diametro del connettore • Diâmetro do conector</p>
 <p><b>5000min<sup>-1</sup></b></p>	<p>Cord revolutions per minute • Обороти на кордата • Rotatii pe minut • Fir • Obrtaji strune • Вртежи на конецот во минута • Скорост шпалат • Hitrosti vrvi • Τοχύτητα νήματος • Brzina viti • Tours de corde par minute • Rotazioni del cavo al minuto • Kabloturnoj je minuto • Rotações de cabo por minuto</p>	 <p><b>3</b> <b>A</b></p>	<p>AC Current • Големина на тока • Amperaj • Struja • Тек • Переменный ток • Izmenični tok • Εναλλασσόμενο ρεύμα • Veličina struje • Courant alternatif • Corrente AC • AC-Fluo • Corrente alternada</p>
 <p><b>255mm</b></p>	<p>Blade diameter • Диаметър на ножа • Diametru lama • Prečnik noža • Диаметр на ножот • Диаметр лезвия • Premer rezila • Διαμέτρος λαιός • Promjer noža • Diamètre de la lame • Diametro della lama • Klingo diametro • Diâmetro da lâmina</p>	 <p><b>18</b> <b>V</b></p>	<p>Voltage • Напрежение • Voltaj • Voltaža • Нанон • Напряжение • Napetost • Δυνάμικό • Napon • Tension • Voltaggio • Tensio • A tensão</p>
 <p><b>4 tons</b></p>	<p>Maximum splitting force • Максимална сила на цепене • Forta maxima de spintecare • Maksimalna snaga seranja • Максимална сила на цепене • Максимальная сила расщепления • Najveća serpilna sila • Μέγιστη δύναμη σχίσματος • Maksimalna snaga razbijanje • Force de fente maximale • Massima forza di spaccatura • Maksimuma forto • Força máxima de divisão</p>	 <p><b>COLOR BOX</b></p>	<p>Wrap in Color box • Опаковано в цветна кутия • Ambalaj colorat • Ураковано u kutiji u boji • Спакувано во кутија • Оберните в коробе цвета • Zavijte ga u rolju barva • Τυλίξτε σε κουτί χρώματος • Pakiranj u kutiji u boji • Envelopper dans la boîte de couleur • Avvolgi nella scatola dei colori • Envolviço en kolora skatolo • Embrulhar em caixa de cor</p>
 <p><b>3 functions</b></p>	<p>Functions of chiselling and drilling • Функции на къртене и пробиване • Funcțiile dăltuire și găurire • Funcție ștețovanje i bušenje • Функции на къртене и дупчење • Функции долблениа и сверления • Funkcije Dlejenje in vrtanje • Αετορυξής του καλέμιου και τρύπανο • Funkcije dijelom i bušenje • Fonctions de burnage et de forage • Funzioni di cesellatura e foratura • Funkcioj de dizilo kaj borado • Funções de cinzelamento e perfuração</p>	 <p><b>impeller X6</b></p>	<p>Number of impellers • Брой на турбините • Numărul de turbinelor • Broj turbinama • Број на турбините • Количество турбинами • Število turbin • Αριθμός τουρτινίτες • Broj turbine • Nombre d'impérateurs • Numero di impreatori • Nombro de impellers • Número de impellers</p>
 <p><b>3.5</b> <b>J</b></p>	<p>Hammer energy per stroke • Макс. енергия на единичен удар • Max. energie provenind un pumn singur • Maks. energija jednog udarca • Макс. енергия на еден удар • Макс. Энергия, получаемая одним ударом • Max. energija, pridobijena en udarec • Max. Енергија поу троухрети јед ендика уроби • Max. energija jednom potezu • Marteau énergie par coup • Energia del martello per colpo • Martela energio per streko • Energia do martelo por curso</p>	 <p><b>Smax</b> <b>8 m</b></p>	<p>Maximum suction height • Максимална смукателна височина • Înălțimea maximă de aspirație • Maksimalna visina usisavanja • Максимална височина всмукывање • Максимальная высота всасывания • Najveća sesalna visina • Μέγιστο ύψος ανάρρησης • Maksimalna visina usisavanja • Hauteur d'aspiration maximale • Altezza massima di aspirazione • Maksimuma aspira altoce • Altura máxima de sucção</p>
 <p><b>610mm</b> <b>(max)</b></p>	<p>Cutting length • Дължина на рязане • Lungime taiere • Dužina sečenja • Должина на сечење • Дължина реза • Dolžina rezanja • Κοπή μήκος • Duljina rezanja • La longueur de coupe • Lunghezza di taglio • Trañca longo • Comprimento de corte</p>	 <p><b>750 mm</b> x <b>520 mm</b></p>	<p>Table dimensions • Размери на работния плот • Dimensiuni masa de lucru • Dimenzije radne površine • Димензии на работна плоча • Размери рабочего • Namizne dimenzij • Διαστάσεις επιφάνειας εργασίας • Dimenzije radna površina • Dimensions de la table • Dimensioni della tabella • Tabla-dimensioj • Dimensões da mesa</p>
 <p><b>65 mm</b></p>	<p>Cutting depth in wood • Дълбочина на рязане в дърво • Adâncime taiere in lemn • Dubina sečenja kroz drvo • Длабочина на сечење во дрво • Глубина пропила в дрвесине • Globina reza • Βάθος κοπής σε ξύλο • Dubina rezanja u drvu • Profondeur de coupe dans le bois • Profondità di taglio in legno • Trañca profundo en ligno • Profundidade de corte em madeira</p>	 <p><b>2x GEARS</b></p>	<p>Air volume (flow) • Дебит на въздуха • Volum de aer evacuat • Protok vazduha • Капацитет на въздух • Расход воздуха • Pretok zraka • Ροή του αέρα στον κινητήρα • Цехастотра • Protok zraka • Consommation d'air • Consumo d'aria • Aera konsumo • Consumo de ar</p>
 <p><b>65 mm</b></p>	<p>Cutting depth in metal • Макс. дълбочина на рязане в метал • Adâncime maximă de taiere in metal • Maksimalna dubina sečenja kroz metal • Максимална длабочина на сечење во метал • Максимальная глубина резания металлов • Najveća globina reza u kovino • Μέγιστο βάθος κοπής μετάλλων • Maks. dubina rezanja u metalu • Profondeur de coupe max en metal • Massima profondità di taglio in metallo • Maksimuma trañca profundo en metalo • Profundidade máxima de corte em metal</p>	 <p><b>6 mm</b></p>	<p>Hose inner diameter • Вътрешен диаметър на маркуча • Diametru interior furtun • Unutrašnji prečnik creva • Внатрешен диаметар на цревето • Внутренний диаметр шланга • Notranji premer cevi • Συλλήνω εσωτερικής διαμέτρου • Unutarnji promjer cijevna • Diamètre intérieur du tuyau • Diametro interno del tubo • Diâmetro interno da mangueira</p>
 <p><b>8 mm</b></p>	<p>Cord diameter • Диаметър на кордата • Diametru cablu • Prečnik strune • Диаметр на кабелот • Шур диаметром • Niz premer • Διαμέτρος καλωδίου • Promjer viti • Diamètre du cordon • Diametro del cavo • Korda diametro • Diâmetro do cabo</p>	 <p><b>max</b> <b>11 mm</b></p>	<p>Cutting capacity (max) • Рязане капацитет (max) • Capacitate maxima taiere • Kapacitet sečenja (max) • Макс. Капацитет на сечење • Режущая способность (макс) • Rezanje (max) • Διεισδυτική κοπή (max) • Rezanje kapaciteta (max) • Capacité de coupe (max) • Capacità di taglio (max) • Trañcantu kapacito (maksimumo) • Capacidade de corte (max)</p>

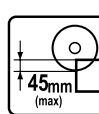
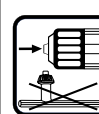

## Meaning of Pictograms / Описание на Пиктограмите











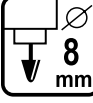







 <p><b>196 cm<sup>3</sup></b></p>	<p>Cylinder displacement • Работен обем на двигателя • Dislocare cilindrica • Radna zapremina motora • Работна зафатнина на цилиндерот • Рабочий объем цилиндра • Valja • Κυβισμός • Capacitat motora • Déplacement de cylindre • Cilindrata • Cilindra movo • Deslocamento do cilindro</p>	 <p><b>1/2" inch</b></p>	<p>Wrench size • За вложки • Dimensiune cliket • Za uložke • Големина на вложката • Размер ключа • Velikost ključa • Μέγεθος κλειδιού • Za umetnica • Taille de la clé • Misura della chiave • Slosila grandeco • Tamanho da chave</p>
 <p><b>min H 180 mm</b></p>	 <p>Case packing • Куфар • Cutie • Upakovano u koferu • Купер • Чемодан • Zadeva pakiranje • Υπόθεση Συσκευσία • U kofer Emballage de cas • Imballaggio della cassa • Skatola pakado • Embalagem da caixa</p>	 <p><b>Pmax 0.7 MPa</b></p>	<p>Maximum pressure • Максимално работно налягане • Maxima presiune de lucru • Maksimalni radni pritisak • Максимален работен притисок • Максимальное рабочее давление • Najveća delovni tlak • Μέγιστη πίεση εργασις • Maksimalni radni tlak • Pression maximale • Pressione massima • Maksimuma premo • Pressão máxima</p>
 <p><b>max H 340 mm</b></p>	 <p>Blister packing • Опаковка блистер • Blister • Upakovano u kesji • Блистер пакување • Блистерной упаковки • Pretisni pakiranje • Συσκευσία Κυψέλη • Emballage blister • Imballaggio in blister • Blister-pakado • Embalagem blister</p>	 <p><b>P 0.5 MPa</b></p>	<p>Working pressure • Работно налягане • Presiune de lucru • Radni pritisak • Работен притисок • Рабочее давление • Delovni tlak • Πίεση λειτουργίας • Radni tlak • Pression de travail • Pressione lavorativa • Laboranta premo • Pressão no trabalho</p>
 <p><b>max H 110 mm</b></p>	 <p><b>220V-50Hz</b></p>	 <p><b>16-40mm</b></p>	<p>Staples width • Височина на скобите • Latime carpe • Širina munjice za heftanje • Ширина на мунцијата • Ширина скобках • Širina objemke • Πλάτος του σφιγκτήρα • Visina zagradi • Largeur des agrafes • Larghezza delle graffette • Bukloj largó</p>
 <p><b>max H 50 mm</b></p>	 <p>Manual start the engine • Ръчно стартиране на двигателя • Pomire manuala • Ručno stratiranje motora • Рачно стартување на моторот • Ручной запуск двигателя • Ročni zaopn motorja • Χειροκίνητη εκκίνηση του κινητήρα • Ručno pokretanje motora • Démarrage manuel du moteur • Manuale avvia il motore • Manilbro startigas la motoron • Manual de arranque do motor</p>	 <p><b>5.7mm 1.2mm</b></p>	<p>Staples dimensions • Размер на скобите • Dimensiuni carpe • Dimenje munjice za heftanje • Големини на мунцијата • Размер скобках • Velikost nosilci • Μέγεθος σφιγκτήρα • Velicina zagradi • Largura dos grampos</p>
 <p><b>3m</b></p>	 <p><b>1.6-4mm</b></p>	 <p><b>100 pcs</b></p>	<p>Number of nails in the magazine • Брой пируни в пълнителя • Numărul de cuie în revista • Брой еккера у магазину • Брой на клинци во пълнителя • Количество гвоздей в магазине • Številko žebeljev v reviji • Αριθμός κορδών στο περιόδιο • Broj noktiju u magazini • Nombre de clous dans la cartouche • Numero di chiodi nella cartuccia • Nombro da ungoj en la kartčo • Número de pregos no cartucho</p>
 <p><b>500gr</b></p>	 <p><b>Ø120 mm</b></p>	 <p><b>30 pcs/min</b></p>	<p>Nails per minute • Брой пируни в минута • Cuie per minut • Ekseri u minuti • Клинци во минута • Гвозди в минуту • Žebli na minuto • Κορδών ανά λεπτό • Broj noktiju minuti • Ongles par minute • Unghie al minuto • Najloj por minuto • Unhas por minuto</p>
 <p><b>500mm</b></p>	 <p><b>6-12 m</b></p>	 <p><b>15-50mm</b></p>	<p>Nails length • Дължина на пируните • Lungime cuie • Duzina eksera • Должина на клинци • Гвозди динии • Žebli dolžina • Κορδών μήκος • Duljina noktiju • Longueur des ongles • Lunghezza dei chiodi • Longa ungoj • Comprimento de unhas</p>
 <p><b>max 5mm</b></p>	 <p><b>Ø5.7mm</b></p>	 <p><b>H D</b></p>	<p>Nails dimensions • Размер на пируните • Dimensiune cuie • Dimenjej eksera • Големини на клинци • Гвозди размери • Žebli dimenzije • Κορδών διαστάσεις • Velicina noktiju • Dimensions des ongles • Dimensiuni dei chiodi • Dimensiaj ungoj • Dimensões de unhas</p>
 <p><b>560mm 360mm</b></p>	 <p><b>22 + 1</b></p>	 <p><b>0.058" (1.5mm)</b></p>	<p>Thickness of units of the chain leading • Дебелина на водещите звена • Grosime zale lant • Debljina zubaca • Дебелина на водичката на забецот • Толщина единици цепи ведущих • Debljina vodilnih enot • Πάχος των μονάδων της αλυσίδας οδηγών • Debljina od vodečih jedinica • Epaisseur des unités de la chaîne en tête • Spessore delle unità della catena che porta • Dikeco de unuoj de la čeno kondukanta • Espessura das unidades da cadeia principal</p>
 <p><b>DUST CAPTURE ПРАХО-УПЛАВЯНЕ</b></p>	 <p><b>0-40 000 min<sup>-1</sup></b></p>	 <p><b>X 72</b></p>	<p>Number of units of the chain leading • Брой на водещите звена на верига • Capacitate rezervor combustibil • Broj zubaca u lancu • Брой на заци на ланецот • Число единици цепи ведущих • Številko enot v verigi, ki vodijo • Αριθμός μονάδων της αλυσίδας που οδηγεί • Broj jedinica vodečeg lanca • Nombre d'unités de la chaîne en tête • Numero di unità della catena che porta • Nombro da unuoj de la čeno kondukanta • Número de unidades da cadeia principal</p>
 <p><b>3/4"</b></p>	 <p><b>CONCRETE</b></p>	 <p><b>0.325"</b></p>	<p>Drilling in concrete • Пробиване в бетон • Gaurire in beton • Пробияње kroz beton • Дупчење во бетон • Сверления в бетоне • Vrtanje v betonu • Διείσθηση σε μπετόν • Bušenje u betonu • Max. diamètre de perçage dans le béton • Maks. borana diameter in betono • Max. diámetro de perforação concreto</p>

# Meaning of Pictograms / Описание на Пиктограмите

 <p>Maximum drilling diameter with holesaw arbor • Макс. диаметър на пробиване с боркорона • Diametru maxim găurire carota • Maks. prečnik probijanja s krunska glava • Макс. диаметар на дупченье с круна • Макс. диаметър сверления с коронка • Maksimalni premer vranja krona • Διάμετρος τριπύρατος σε κορυφή • Бушење с Круна • Diamètre de perceuse maximum avec arbre de sciage • Diametro massimo di foratura con albero a sega • Maksimuma borado diametro kun holeaw arbor • Diámetro máximo de furação com mandril de furos</p>	 <p>Power settings • Степени на мощност • Setările de putere • Postavke aparajanja • Степени на моќност • Настройки питания • Nastavitve porabe • Ρυθμίσεις ενέργειας • Postavke aparajanja • Paramètres de puissance • Impostazioni di potenza • Potencaj agorodj • Configurações de energia</p>	 <p>Maximum width of the workpiece • Максимална ширина на обработвания детайл • Dimensiune maxima de prelucrat • Maksimalna širina obradivog predmeta • Максимална широчина на работното парче • Максималная ширина заготовки • Najveća širina obdelovanca • Μέγιστο πλάτος του τεμαχίου • Maksimalna širina komada • Largeur maximale de la pièce • Larghezza massima del pezzo • Maksimuma laržo de la peco • Largura máxima da peça de trabalho</p>
 <p>Oscillations • Осцилации • Oscilație • Oscilação • Oscilazioni • Осцилляция • Oscilacija • Ταλάντωση • Oscilranja • Oscillations • Oscillazioni • Osciljo • Oscilações</p>	 <p>Heated area • Отопляема площ • Zona încălzită • Grejana površina stambenih • Загрева површина • Отопляемое помещение • Ogrevanih prostor • Огривановейт период • Grijanu prostorju • Zone chauffée • Area riscaldata • Varmigita areo • Área aquecida</p>	 <p>Planing depth • Дълбочина на рендосване • Adancime maxima prelucrare • Dubina rezanja • Дълбочина на стругане • Глубина строгания • Nastavljiva globina utora • Βάθος πλάνισης • Dubina planiranje • Profondeur de planification • Profundità di pianificazione • Planado de profundo • Profundidade de planejamento</p>
 <p>Oscillations angle • Ъгъл на осцилациите • Unghiul Oscilație • Oscilação ungo • Oscilazioni под агол • Угол Осцилляция • Kot Oscilacija • Γωνία Ταλάντωσης • Kut Oscilranja • Angle des oscillations • Angolo delle oscillazioni • Osciljo-angulo • Angulo de oscilação</p>	 <p>Length, width and height • Дължина, ширина и височина • Lungimea, lățimea și înălțimea • Dužina, širina i visina • Должина, ширина и висина • Дължина, ширина и висота • Dolžina, širina in višina • Μήκος, το πλάτος και το ύψος • Dužina, širina i visina • Longueur, largeur et hauteur • Longueur, largeur et hauteur Longueur, largeur et hauteur • Comprimento, largura e altura</p>	 <p>Maximum cutting depth • Максимална дълбочина на рязане • Adancime maxima de taiere • Maksimalna dubina sečenja • Максимална дълбочина на сеченье • Maksimalna dubina rezanja • Μέγιστο βάθος κοπής • Najveća dubina rezanja • Profondeur de coupe maximale • Massima profondità di taglio • Maksimuma tranča profundo • Profundidade máxima de corte</p>
 <p>Warm-up time • Време за загряване • Timp de incalzire • Vreme zagrevanja • Време за загревање • Время прогрева • Cas toplo • Χρόνος προθέρμανσης • Toplo vrijeme • Temps de préchauffage • Tempo di riscaldamento • Varmigita tempo • Hora de aquecimento</p>	 <p>Ingoing amount air • Входящо количество въздух • Intrăni aer • Ulazi vazduha • Дојдовен количество воздух • Входи воздуха • Входи zraka • Είσοδος αέρα • Ułaza zraka • Quantitè d'air entrant • Quantità d'aria in entrata • Enirado de aero • Quantidade de entrada de ar</p>	 <p>Cutting length • Дължина на рязане • Lungime taiere • Dužina sečenja • Должина на сеченье • Дължина реза • Dolžina rezanja • Κοπή μήκος • Duljina rezanja • La longueur de coupe • Lunghezza di taglio • Tranča longo • Comprimento de corte</p>
 <p>Liquid volume • Капацитет • Volum • Capacitet • Капацитет • Емкост • Zmogljivost • Χωρητικότητα • Capacitet • Volume de liquide • Volume liquido • Likva volumo • Volume liquido</p>	 <p>Outgoing air quantity • Изходящо количество въздух • Cantitate de aer de ieșire • Odlazeci količina vazduha • Појдовен количество воздух • Исходящие количество воздуха • Odlazni količina zraka • Εξέρχόμενη ποσότητα αέρα • Odlazni količina zraka • Quantitè d'air sortant • Quantità d'aria in uscita • Kvantò de ekstera aeron • Quantidade de ar de saída</p>	 <p>Flow rate • Скорост на струята • Debitul • Protok • Брзина на млазот • Скорост потока • Pretok • Ένας ρυθμός ροής • Protok • Debit • Portata • Fluo-rapideco • Quociente de vazão</p>
 <p>Nozzle diameter • Диаметър на дюзата • Diametru duza • Prečnik mlaznice • Дијаметар на дюзата • Диаметр сопла • Premer šobe • Διάμετρος πτεκ • Promjer mlaznice • Diamètre de la buse • Diametro dell'ugello • Nozzle diametro • Diámetro do bico</p>	 <p>Capacity bag leaves • Капацитет на торбата за листа • Frunze sac Capacitate • Capacitet jastuk lišće • Капацитет на торбата за листови • Вместимость мешка листьев • Zmogljivost torba listi • Φύλλα σακούλα χωρητικότητας • Capacitet jastuka lišće • Capacité sac feuilles • Foglie di capacità • Folioj de sako • Folhas de saco de capacidade</p>	 <p>Capacity • Капацитет • Volum • Capacitet • Капацитет • Емкост • Zmogljivost • Χωρητικότητα • Capacitet • Capacité • Capacità • Kapablo • Capacidade</p>
 <p>Maximum piston stroke • Максимален ход на буталото • Deplasare maxima piston • Maksimalni hod potiskivača • Максимален од на осовината • Максимальный ход • Najveći gib • Μέγιστο εκκεφαλικό ετπασμό • Maksimalni hod • Course maximale du piston • Corsa massima del pistone • Maksimuma streketo • Curso máximo do pistão</p>	 <p>Width of milling • Ширина на фрезование • Lățime de frezare • Širina mlevenja • Ширина на гладане • Ширина фрезерования • Širina rezkanje • Πλάτος του άλεσης • Širina glodanje • Largeur de fraisage • Larghezza della fresatura • Largeco de moliço • Largura da moagem</p>	 <p>Blade Diameter • Диаметър на ножа • Diametru lamă • Prečnik oštrice • Дијаметар на ножот • Диаметр лезвия • Premer reza • Διάμετρος λεπίδας • Promjer noža • Diamètre De La Lame • Diametro lama • Klingo Diameter • Diámetro de la Lámina</p>
 <p>Milling depth • Дълбочина на фрезование • Adâncime de rutare • Dubina rutiranje • Дълбочина на меленье • Глубина фрезерования • Globine rezkanja • Βάθος δρομολόγησης • Dubine glodanje • Profondeur de fraisage • Profundità di fresatura • Muelanta profundo • Profundidade de moagem</p>	 <p>Type of cable • Вид на кабела • Tipul de cablu • Tip kabla • Вид на кабелот • Тип кабела • Vrsta kabla • Τύπος καλωδίου • Vrsta kabela • Type de cable • Tipo di cavo • Tipo de kablo • Tipo de cabo</p>	 <p>Maximum size of solids • Максимален размер на твърдите частици • Dimensiunea maximă a solidelor • Maksimalna veličina čvrstih materija • Максимална големина на цврсти материи • Макс. размер твердых частиц • Maksimalna velikost trdnih delcev • Μέγιστο μέγεθος των στερεών • Maksimalna veličina krutih tijela • Taille maximale des solides • Dimensione massima dei solidi • Maksimuma grandeco de solidoj • Tamanho máximo de sólidos</p>
 <p>Max cutting depth in PE / PP • Макс дълбочина на рязане в PE / PP • Adancime maxima de taiere in PE / PP • Maks. dubina sečenja kroz PE / PP • Максимална дълбочина на сеченье во PE / PP • Максимальная глубина резания PE / PP • Najveća globina reza v PE / PP • Μέγιστο βάθος κοπής PE / PP • Maks. dubina rezanja u PE / PP • Profondeur de coupe max en PE / PP • Profundità di taglio massima in PE / PP • Maksimuma tranča profundo en PE / PP • Profundidade máxima de corte em PE / PP</p>	 <p>Pipe diameter • Диаметър на тръбата • Diametru teava • Prečnik cevi • Дијаметар на тръбата • Диаметр трубы • Premer cevi • Διαμέτρος σωλήνων • Promjer cijevi • Diamètre du tuyau • Diametro del tubo • Tubo diametro • Diámetro do tubo</p>	 <p>Grass cutting height • Височина на косене • Înaltime taiere iarba • Visina košenja • Височина на косенье • Высота стрижки травы • Visina Sprej • Υψος ψεκστοίου • Visina prskanje • Gamme de liquide verticale • Gamma di liquidi verticale • Likva gamo vertikalna • Vertical liquido</p>
 <p>Maximum cutting depth • Максимална дълбочина на рязане • Adancime maxima de taiere • Maksimalna dubina sečenja • Максимална дълбочина на сеченье • Maksimalna dubina rezanja • Μέγιστο βάθος κοπής • Najveća dubina rezanja • Profondeur de coupe dans le bois • Profundità di taglio in legno • Tranča profundo en ligno • Profundidade de corte em madeira</p>	 <p>Keyless chuck • Бързоазягащ патрончик • Mandrina rapida • Brzozatezajući dodatak • Брзо затегнувачки футер • Быстрозажимной патрон • Hitrovrpenjalna vrtalna glava • Ταχυτόκοκ • Brzozestezna glava • Mandrin sans clé • Mandrino senza chiave • Keyless chuck • Mandril sem chave</p>	 <p>Basket capacity • Объем на кош за трева • Capacitate cos colector • Zapremina košre za travu • Капацитет на корпата за трева • Объем корзины травы • Obseg trave košarico • Όγκος υροσπίθ κοάβι • Obujam prikupljanje trave • Capacité du panier • Capacità del cesto • Korpa kapacito • Capacidade do cesto</p>
 <p>Cable cord length • Дължина на кабела • Lungime cablu alimentare • Dužina kabla • Должина на кабелот • Дължина кабела • Dolžina kabla • Καλώδιο μήκος • Duljina kabla • Longueur du cordon • Lunghezza del cavo • Longa snuro de kablo • Comprimento do cabo</p>	 <p>Grass cutting diameter • Диаметър на косене • Diametru taiere iarba • Prečnik košenja • Дијаметар на косенье • Диаметр стрижки травы • Premer pri rezanju • Διαμέτρος κοπής χόρτου • Promjer košnje • Diamètre de coupe de l'herbe • Diametro di taglio dell'erba • Herbo de diametro • Diámetro de corte de grama</p>	 <p>Liquid range vertical • Височина на пръскане • Înălțimea pulverizare • Visina sprej • Височина на пръскане • Высота распыления • Visina Sprej • Υψος ψεκστοίου • Visina prskanje • Gamme de liquide verticale • Gamma di liquidi verticale • Likva gamo vertikalna • Vertical liquido</p>
 <p>Hose inner &amp; outer diameter • Вътрешен и външен диаметър на маркуча • Diametru interior-exterior furtun • Unutrašnji i spojašnji prečnik ceva • Вънтрешен и надворешен диаметар на цревето • Шланг внутренни и внешний диаметр • Notranji in zunanji premer cevi • Σωλήνος εσωτερική &amp; εξωτερική διάμετρο • Unutarnji i vanjski promjer cijeva • Diamètre intérieur et extérieur du tuyau • Diametro interno ed esterno del tubo • Hoso ena kaj ekstera diametro • Diámetro interno e externo da mangueira</p>	 <p>Oil tank capacity • Объем на резервоара за масло • Capacitate rezervor ulei • Zapremina rezervoara za ulje • Капацитет на резервоарот за масло • Емкост млясногo бака • Prostornina rezervoarja olja • Χωρητικότητα δεξαμενής λαδιού • Obujam spremnika ulja • Capacité du réservoir d'huile • Capacità del serbatoio dell'olio • Kapacito de nafno-tanko • Capacidade do tanque de óleo</p>	 <p>Liquid range horizontal • Дължина на хоризонтално пръскане • Evacuare lichid la orizontala • Dužina horizontalno prskanja • Должина на пръскане хоризонтално • Дължина хоризонталното распыление • Dolžina horizontalne razpršila • Μήκος των οριζόντιων ψεκστοίου • Duljina horizontalne prskanje • Gamme de liquide horizontale • Gamma di liquidi orizzontale • Likva gamo horizontalna • Intervalo liquido horizontal</p>

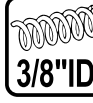

## Meaning of Pictograms / Описание на Пиктограмите

 <p><b>40 pcs</b></p>	<p>Accessory quantity • Брой в комплекта • Nr. Accesorii • Број комада у комплекту • Број на додатоци • Аксесуари количество • Dodatna količina • Ποσότητα Αξεσουάρ • Broj isporučuje • Quantité d'accessoire • Quantità di accessori • Aksesora kvanto • Quantidade acessória</p>	 <p><b>8 mm</b></p>	<p>Fuel tank capacity • Объем на резервоара за гориво • Capacitate rezervor combustibil • Zapremina rezervoara za gorivo • Капацитет на резервоарот за гориво • Емкость топливного бака • Zapremina rezervoarja za gorivo • Χωρητικότητα δεξαμενών • Obujam spremnika goriva • Capacité du réservoir de carburant • Capacità della tanica di benzina • Kapacito de benzinujo • Capacidade do tanque de combustivel</p>
 <p><b>1.8 m</b></p>	<p>Hose length • Дължина на маркуча • Lungime furtun • Dužina creva • Должина на црево • Длина шланга • Dolžina cevi • Μήκος σωλήνα • Dujlina crjeva • Longueur du tuyau • Lunghezza del tubo • Longitudo de tubo • Comprimento da mangueira</p>	 <p><b>Length 100mm</b></p>	 <p><b>18" 450mm</b></p>
	<p>Always wear protective mask • Винаги носете предпазна маска • Purtați masca de protecție • Uvek nosite zaštitnu masku • Задолжително користете заштитна маска • Всегда надевайте защитную маску • Vedno nosite zaščitno masko • Πάντα να φοράτε προστατευτική μάσκα • Uvijek nosite zaštitnu masku • Toujours porter un masque de protection • Indossare sempre una maschera protettiva • Ciam surhavas protektan maskon • Sempre use máscara de proteção</p>	 <p><b>230 mm 280 mm</b></p>	 <p><b>1.2 L/h</b></p>
	<p>Always wear protective earmuffs • Винаги носете антифони • Purtați casti de protecție pentru urechi • Uvek nosite zaštitu za uši • Задолжително користете заштитни слушалки • Всегда надевайте защитные наушники • Vedno nosite zaščitna muhi uho • На φοράτε πάντα προστατευτικά αυστοσπίδες • Uvijek nosite štítneke za uši • Toujours porter des cache-oreilles protecteurs • Indossare sempre cuffie antirumore • Ciam surhavas protektajn orellingojn • Use sempre protetores de ouvido protetores</p>	 <p><b>LIQUID ≥ 4 L/min</b></p>	 <p><b>AUTO</b></p>
	<p>Always wear protective glasses • Винаги носете предпазни очила • Purtați manusi de protecție • Uvek nosite zaštitne naočare • Задолжително користете заштитни наочари • Всегда надевайте защитные очки • Vedno nosite zaščitna očala • На φοράτε πάντα προστατευτικά γυαλιά • Uvijek nosite zaštitne naočale • Toujours porter des lunettes de protection • Indossare sempre occhiali protettivi • Ciam surhavas protektajn okulvitrojn • Use sempre óculos de proteção</p>	 <p><b>DUST ≥ 6 L/min</b></p>	 <p><b>0.14 sec</b></p>
 <p><b>SDS+</b></p>	<p>SDS-plus Tip • Захаат SDS-plus • Tip SDS Plus • SDS-plus Tip • SDS Plus Tip • Пика SDS-Plus • SDS-plus Tip • Κορυφή SDS-plus • Nositelj SDS-plus • Conseil SDS-plus • Suggestimento SDS-plus • SDS-plus Tip • Dica SDS-plus</p>	 <p><b>20 L</b></p>	 <p><b>3/8" ID</b></p>
 <p><b>SDS+</b></p>	<p>SDS-plus adapter • SDS-plus адаптер • Adaptor SDS plus • SDS-plus adapter • SDS Plus Адаптер • SDS-Plus адаптер • SDS-plus adapter • SDS-plus приспособление • SDS-plus adapter • Adaptateur SDS-plus • Adattatore SDS-plus • SDS-plus adaptilo • Adaptador SDS-plus</p>	 <p><b>TANK 100L</b></p>	 <p><b>1/4"</b></p>

# RAIDER®

**20**  
YEARS  
ANNIVERSARY

## Марката Raider през годините

Уважаеми клиенти и партньори,

Пред вас е новият каталог на Raider 2020 год., където можете да намерите цялостни решения за Вашия бизнес сред богатия избор от акумулаторни, електрически, бензинови и пневматични машини и консумативи за тях. Този каталог включва 1600 артикули, от които 375 са нови.

Марката Raider е собствен бранд на Евромастер Импорт Експорт ООД, познат и утвърден на българския пазар от двадесет години. Разнообразието на машини в този бранд, покрива практически целия диапазон дейности - строителство, дървообработване, металообработване, авто- и градинска техника. Предлагаме и пълна гама съответни консумативи, съвместими не само с машините с бранд Raider. След успешния старт през 2000 година, марката Raider не е изменила на визията и мисията си, базирани на потребностите и очакванията на потребителите. Съобразно тях сме обновили асортимента си, достигайки по-високо технологично равнище.

Ценностите, на които се гради успехът ни са:

- Технологично качество, отговарящо на високи професионални изисквания, на разумна, достъпна и конкурентна цена;
- Качество, на което клиентите се доверяват;
- Стабилни, открити и честни взаимоотношения с бизнес партньори, производители и дистрибутори;
- Професионална и лична отговорност за поетите рискове и взетите решения.

С новите машини и усъвършенстването на моделите, спечелили Вашето доверие с доказаното си качество, ние добавяме допълнителни ползи и предимства и адаптираме продуктите към пазарната среда, за да продължава Raider да бъде най-доброто предложение при избор на машини за интензивна работа при професионални условия. След утвърждаването на продуктите в България, Raider успешно разширява дистрибуторската си мрежа и пазарния си дял в редица страни от Централна и Източна Европа.

## Raider Brand over the years

Dear Customers and Partners,

The trademark Raider celebrates its 20th birthday anniversary during this year.

Now you have our new Raider product catalogue, where you can find complete solutions for your business among the wide selection of electric, gasoline and pneumatic equipment and consumables. This catalog includes 1600 articles, of which 375 are new.

Raider brand is Euromaster Import - Export Ltd. own brand known and recognized on Bulgarian market for twenty years. The variety of instruments with this brand covers practically the whole range of activities - construction, woodworking, metalworking, auto- and garden equipment. The variety of machines with this brand covers practically the whole range of activities - construction, woodworking, metalworking, auto- and garden equipment. We offer also a full range of related accessories, compatible not only with Raider brand machines.

After the successful launch in 2000, Raider brand has not altered its vision and mission based on the needs and expectations of consumers; we have upgraded its range accordingly, reaching a higher level of technology. The values upon which our success was built are:

- Technological quality meeting the highest professional requirements at a reasonable, affordable and competitive price;
- Quality that customers trust;
- Stable, open and honest relationships with business partners, manufacturers and distributors;
- Professional and personal responsibility for the taken risks and decisions.

With the new machines and improvement of models, which earn your trust with proven quality, we add additional benefits and advantages and adapt our products to the market environment to keep being RAIDER best deal when choosing a machine for intensive use in a professional environment.

With the recognition of the products in Bulgaria, Raider has been successfully expanding its market share and developing its distribution network in several countries of Central and Eastern Europe.

### ЕВРОМАСТЕР Импорт Експорт ООД

Р. България, 1231 София,  
бул. "Ломско шосе" 246  
тел.: 0700 44 155 за цялата страна  
e-mail: info@euromasterbg.com  
www.euromasterbg.com

### EUROMASTER Import Export Ltd.

Bulgaria, 1231 Sofia,  
246 Lomsko Chaussee Blvd.  
tel.: (00 359) 87 530 0101  
e-mail: info@euromasterbg.com  
www.euromasterbg.com

### EUROMASTER SRL Romania

Str. Drumul Garii Otopeni,  
Nr. 6, Otopeni, Ilfov  
Tel.: +4 021 3510106  
e-mail: info@euromasters.ro  
www.euromasters.ro

"Евромастер Импорт Експорт" ООД, информира, че авторските права на този каталог, включващи неговия текст, поместените фотографии, пиктограми, схеми, чертежи и дизайн, принадлежат изключително на "Евромастер Импорт Експорт" ООД и подлежат на правна защита съгласно „Закона за авторското право и сродните му права“ влязъл в сила на 01.08.1993 г. и последните изменения публикувани в „Държавен вестник“ бр. 32 от 28 Април 2009г.

Копирането, публикуването, модифицирането с комерсиална цел на каталога, както и на отделни елементи от него без съгласието на "Евромастер Импорт Експорт" ООД изразено в писмена форма, е строго забранено и може да доведе до привличането към гражданска и наказателна отговорност.

[www.raider.bg](http://www.raider.bg)





070044155



info@euromasterbg.com



www.raider.bg

Art. № 108028



**Euromaster Import-Export Ltd**  
Bulgaria  
1231 Sofia  
246, "Lomsko shaussee" blvd  
www.raider.bg  
www.euromasterbg.com

